

Update



KOMPATIBLE PROFILREIHEN & SYSTEM-ENGINEERING

> COMPATIBLE PROFILE RANGES
> SERIES DE PROFILES COMPATIBLES

ALUPROFIL

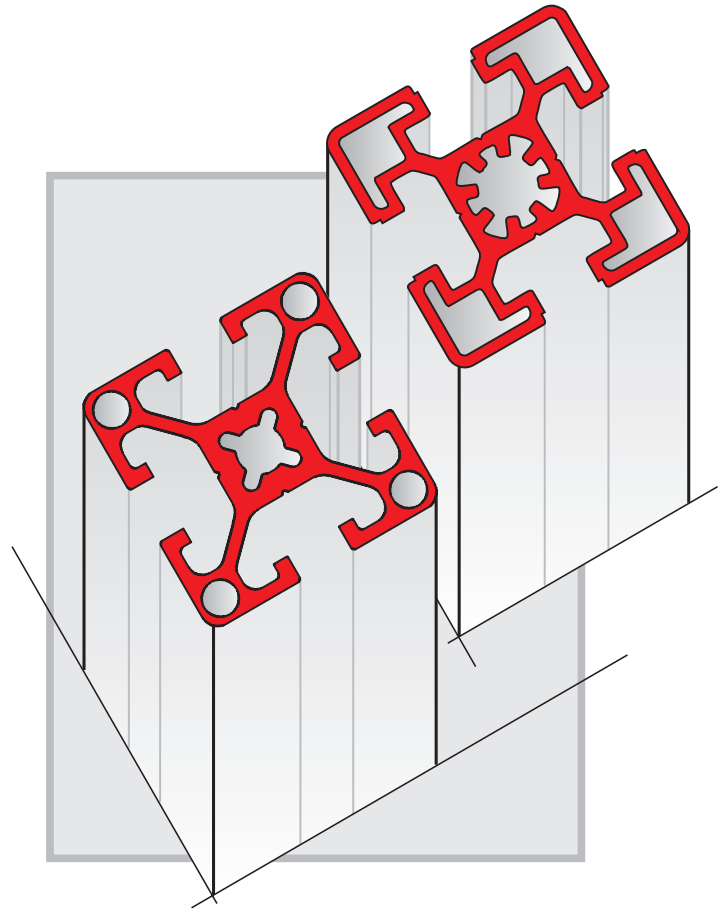

... UND WIEDER GUT GELÖST!

... ONCE AGAIN SOLVED QUITE SMART

... ET ENCORE UNE FOIS BIEN RÉSOLU



„Mit Konzepten für eine **schlanke Produktion** und **Intralogistik** verhelfen wir Unternehmen zu maximalem Erfolg.“

> *“We help companies achieve maximum success with concepts for lean production and intralogistics.”*

> *« Nous aidons les entreprises à atteindre un maximum de succès avec des concepts de production allégée et d'intralogistique. »*



Effiziente Technik

- > *Efficient technology*
- > *Technologie efficace*



Kundenspezifische Lösungen

- > *Customized solutions*
- > *Solutions sur mesure*



Alles aus einer Hand

- > *All from one hand*
- > *Tout d'une source*

Produktvielfalt

- > *Product variety*
- > *Variété des produits*

Aluprofilsystem

- > *Aluminium profile system*
- > *Systèmes de profilé d'aluminium*



ECO-Rohrstecksystem

- > *ECO tube connector system*
- > *Système de tubes ECO*



Arbeitsplatzsystem

- > *Workplace system*
- > *Système de postes de travail*



MySHADOWBOARD

- > *MySHADOWBOARD*
- > *MySHADOWBOARD*



Schutzzaunsystem

- > *Protective fence system*
- > *Système de barrière de protection*



Fördertechnik

- > *Conveyor technology*
- > *Technique d'acheminement*



Mehr Informationen unter ...

- > *More information at ...*
- > *Plus d'informations sous ...*



www.fm-systeme.com

INHALT
CONTENTS
SOMMAIRE



SYSTEM-BESCHREIBUNG	SYSTEM DESCRIPTION	PRINCIPE DE BASE	1
ALU-PROFILE	PROFILES	PROFILES	2
VERBINDUNGSELEMENTE	CONNECTION ELEMENTS	ELEMENTS DE JONCTION	3
WINKEL / GELENKE	BRACKETS / JOINTS	EQUERRES / ARTICULATIONS	4
BODENELEMENTE / FÜSSE / RÄDER	FLOOR ELEMENTS / FEET / WHEELS	PIEDS / ROULETTES	5
ABDECKKAPPEN / ZUBEHÖR	CAPS / ACCESSORIES	CACHES / ACCESSOIRES	6
FLÄCHENELEMENTE	PANEL ELEMENTS	REPLISSAGE	7
TÜREN / TÜRELEMENTE	DOORS / DOOR ELEMENTS	PORTES ET ACCESSOIRES	8
INSTALLATIONSELEMENTE	INSTALLATION ELEMENTS	PNEUMATIQUE / ELECTRIQUE	9
ECO-ROHR-SYSTEM	ECO PIPE SYSTEM	ECO MECANO	10
SCHUTZ- UND TRENNSYSTEME	SAFETY AND SEPARATING SYSTEMS	PALLISADES DE PROTECTION	11
LINEARFÜHRUNGSTECHNIK	LINEAR GUIDE TECHNOLOGY	TECHNIQUE DE GUIDAGE LINEAIRE	12
FÖRDERSTRECKENELEMENTE	CONVEYOR SECTIONS ELEMENTS	CONVOYAGES	13
WERKZEUGE UND VORRICHTUNGEN	TOOLS AND DEVICES	OUTILLAGES ET GABARITS	14
ÜBERSICHT BESTELNUMMERN	OVERVIEW OF ORDER NUMBERS	INDEX	15

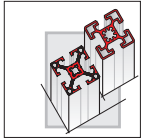

DER WEG ZUM RICHTIGEN PROFIL ... FINDING THE RIGHT PROFILE ... POUR TROUVER LE BON PROFIL ...



Profilreihe

Profile series · Série de profilés

16 / 20

30 / 40 / 45 / 50

Weiter mit Profilgröße
Continue with profile dimension
Dimension du profilé

Weiter mit Profilausführung
Continue with profile designs
Version du profilé

Profilausführung

Profile design
Version de profilé



20



Masse
 I_x / I_y
 W_x / W_y
ab Seite

0,48 kg/m
0,74 cm⁴
0,74 cm³
■ 2.07



30

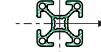

0,81 kg/m
2,78 cm⁴
1,85 cm³
■ 2.13

30-10K

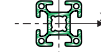

1,00 kg/m
3,17 cm⁴
2,11 cm³
■ 2.19



40EL-1.4

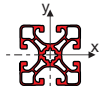

Masse
 I_x / I_y
 W_x / W_y
ab Seite

1,37 kg/m
7,42 cm⁴
3,71 cm³
■ 2.23

40L-1.55

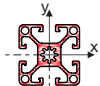

1,55 kg/m
8,40 cm⁴
4,20 cm³
■ 2.23

40-10K

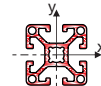

1,60 kg/m
9,46 cm⁴
4,73 cm³
■ 2.39

40N

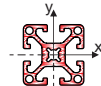

1,72 kg/m
9,66 cm⁴
4,83 cm³
■ 2.29

40MS

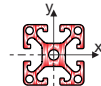

1,90 kg/m
10,52 cm⁴
5,26 cm³
■ 2.43

40S

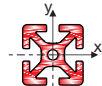

2,45 kg/m
13,90 cm⁴
6,95 cm³
■ 2.47



45EL-1.4

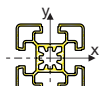

Masse
 I_x / I_y
 W_x / W_y
ab Seite

1,40 kg/m
9,28 cm⁴
4,12 cm³
■ 2.55

45L-1.6

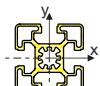

1,60 kg/m
10,17 cm⁴
4,52 cm³
■ 2.55

45N-1.9

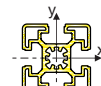

1,90 kg/m
12,95 cm⁴
5,18 cm³
■ 2.61

45MS-2.1

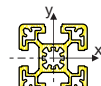

2,10 kg/m
15,56 cm⁴
6,92 cm³
■ 2.65

45S

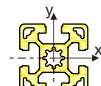

2,62 kg/m
18,95 cm⁴
8,42 cm³
■ 2.65

Profilgröße

Profile dimension · Taille de profilé

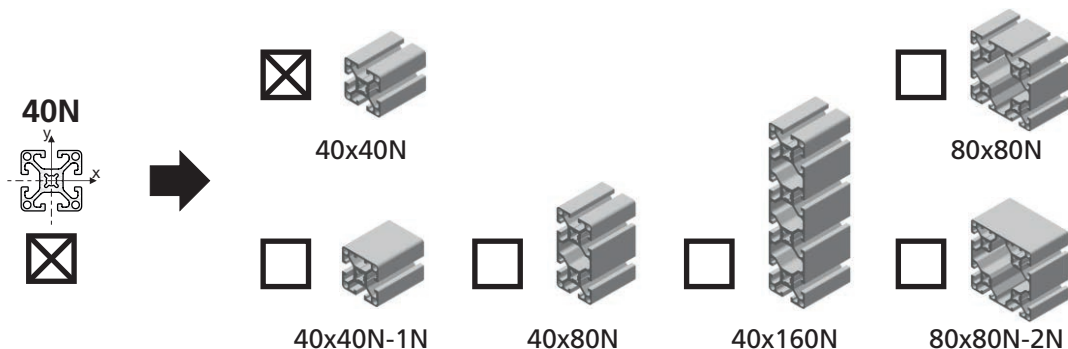

Weiter mit Verbinderauswahl
Continue with connector selection
Choix de la fixation

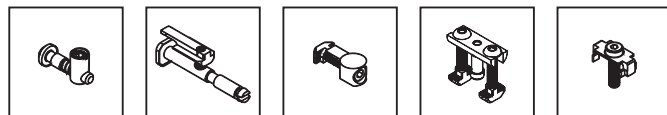

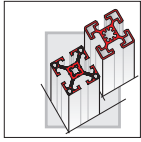

BESCHREIBUNG DES SYSTEMS

DESCRIPTION OF THE SYSTEM

DESCRIPTION DU SYSTEME



• **Umfangreich**

Das FM-Profilsystem ist ein modularer Baukasten mit Grundelementen für den Bau von Rationalisierungs- und Automatisierungseinrichtungen, sowie Anlagen. Mehr als 150 Standard-Strebenprofile bilden die Basis. Profile in Sonderausführung ergänzen das System.

• **Kompatibel**

Die Profile der Baureihe 20 mit Nut 5, der Baureihe 30/40/80 mit Nut 8, sowie die Baureihen 45/60/90 und 50/100 mit Nut 10 sind kompatibel zu den am Markt gängigen Ausführungen.

• **Wirtschaftlich**

Auf Grund der umfangreichen Anzahl an Aluprofilen kann entsprechend der technischen Aufgabenstellung das jeweils wirtschaftlichste Profil gewählt werden.

• **Flexibel**

Ein flexibles, wirtschaftliches und modulares Verbindersystem gewährleistet den Zusammenbau aller vorhandenen Profile. Besonderheit: Einige Verbinder ermöglichen die Kombination unterschiedlicher Profilgrößen sowie Nuttypen.

• **Vielfältig**

Mit den standardisierten und modular aufgebauten Elementen ist es möglich, nahezu allen konstruktiven Herausforderungen gerecht zu werden.

• **Hochwertig**

Die stabilen Profilquerschnitte, die kräftige Nutausführung, die hohe Eloxalstärke sowie die stabile und montagefreundliche Verbindertechnik garantieren eine hohe Qualität.

• **Wiederverwendbar**

Die hohe Qualität sowie die Beständigkeit ermöglichen die Wiederverwendbarkeit der Elemente. Die flexiblen Baukästen garantieren einen stetigen Weiterbau und eine jederzeitige Anpassung der Einrichtungen an geänderte Aufgabenstellungen.

• **Comprehensive modular system**

The FM profile system is a modular concept of basic elements for the construction of rationalisation and automatic systems and equipment. More than 150 standard strut profiles form the basis. Profiles in special design complete the system.

• **Compatible**

The profiles of the 20 series with groove width of 5 mm, the 30/40/80 series with a slot width of 8 mm and the 45/60/90 and 50/100 series with groove width of 10 mm, offer an extremely economical choice according to individual requirements.

• **Economical**

Our economical system with a big variety of profiles, allows FM always to use the most economical profile.

• **Flexibility**

The diversity of the standardised and modular design elements allows virtually unlimited possibilities for construction applications. Special feature: some connectors allow the combination of different profile dimensions and slot-types.

• **Versatile**

It is possible to manage almost all constructive challenges with our standardized and modular elements.

• **High quality**

Sturdy profiles, strong grooves, high anodising strength and a sturdy, easy to assemble connector system offer a high quality.

• **Flexible application and reusability**

This level of quality and resistance ensures longevity, reusability and flexibility of our elements. The modular concept guarantees consistent extension and modification of installations at all times to changes in requirements and situations.

• **Un gamme importante de produits**

Avec plus de 150 profilés standard complétés par des profilés spéciaux, le système FM offre une grande modularité permettant la construction de systèmes de rationalisation et d'automatisation performants.

• **Compatibilité**

Les profilés de la série 20 rainure 5, de la série 30/40/80 rainure 8 ainsi que les séries 45/60/90 et 50/100 rainure 10 sont compatibles avec la plupart des profilés sur le marché. Ils répondent aux impératifs techniques les plus pointus.

• **Un gamme particulière étendue**

La large gamme de profilés aluminium permet de trouver la solution la plus adaptée à vos besoins techniques et économiques.

• **Système de raccordement universel**

Un système de raccordement flexible, économique et modulaire permet une variété presque infinie de constructions. De nombreuses fixations s'adaptent aux deux types de rainures.

• **Nombreuses possibilités d'utilisation**

La diversité des éléments standardisés et de conception modulaire permet une variété presque infinie de constructions.

• **Haute qualité**

La haute qualité repose sur une conception alliant les atouts suivants : sections particulièrement stables, notamment au niveau des rainures, Anodisation haut de gamme, technique d'assemblage solide, rationnelle et conviviale.

• **Flexibilité d'utilisation et récupérabilité**

La grande qualité et la robustesse de nos éléments est le garant de leur longévité. La conception modulaire offre la possibilité d'assembler ces éléments sur des structures déjà existantes, et de permettre de nouvelles adaptations en fonction de l'évolution des impératifs de construction.

PROFIL-ÜBERSICHT

OVERVIEW OF PROFILES

PANORAMA DES PROFILES



■ 2.02

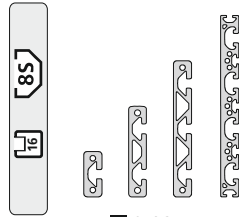

■ 2.03

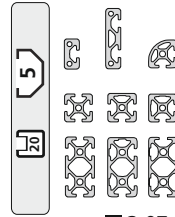

■ 2.07

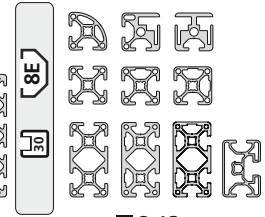

■ 2.13

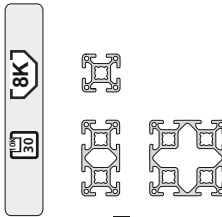

■ 2.19

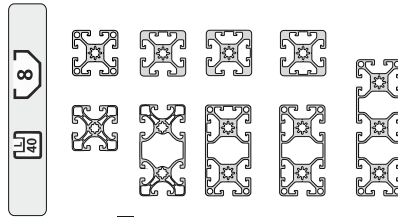

■ 2.23

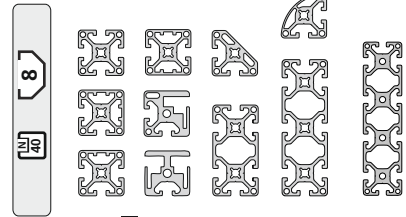

■ 2.29

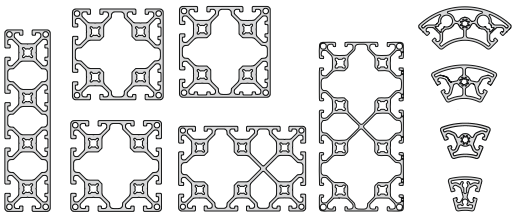

■ 2.39

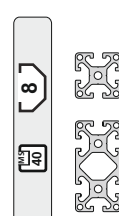

■ 2.43

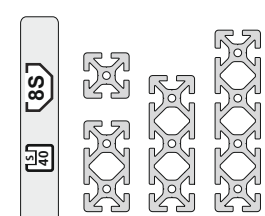

■ 2.47

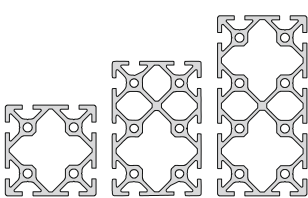

■ 2.55

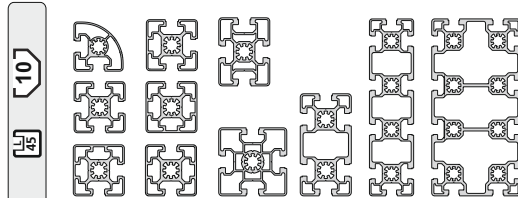

■ 2.63

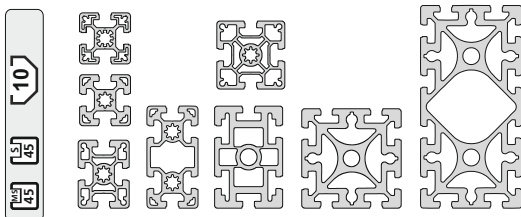

■ 2.67

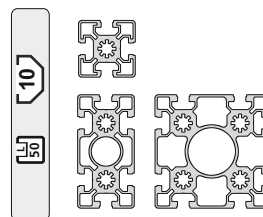

■ 2.71

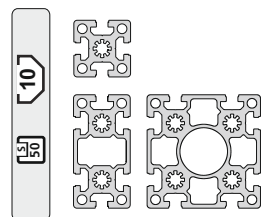

■ 2.75

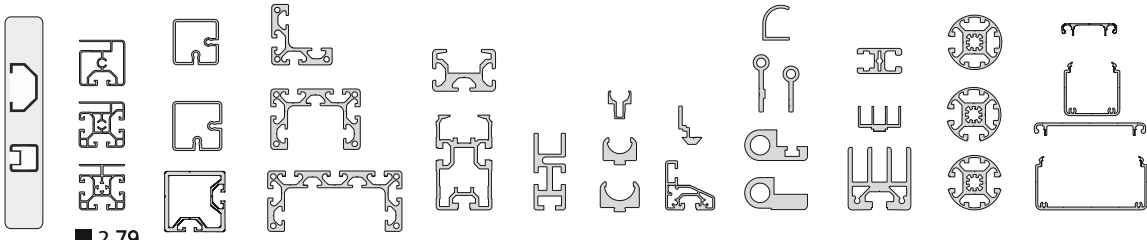

■ 2.79

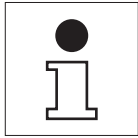

TECHNISCHE DATEN TECHNICAL DATA DONNEES TECHNIQUES



• **Strangpressprofile nach DIN EN 12020**
(Ersatz für DIN 17615)

Werkstoff Al Mg Si 0,5 F25
Werkstoff-Nr. 3.3206.72
(warmausgehärtet)

• **Extruded profiles in compliance with DIN EN 12020**
(Replacement for DIN 17615)

Material: Al Mg Si 0.5 F25
Material no.: 3.3206.72
(furnace aged)

• **Profils extrudés selon DIN EN 12020**
(remplace la norme DIN 17615)

Matière Al Mg Si 0,5 F25
No. matière 3.3206.72
(thermodurci)

• **Lieferlänge** (falls nicht anders angegeben) 6040 mm
Funktionslänge (falls nicht anders angegeben) 6000 mm
Zuschmittstoleranz über alle Längen +/- 1 mm

• **Supplied length** (unless otherwise specified) 6040 mm
Functional length (unless otherwise specified) 6000 mm
Tolerance for all lengths +/- 1 mm

• **Longueur livrée** (sauf spécification contraire) 6040 mm
Longueur fonctionnelle (sauf spécification contraire) 6000 mm
Tolérance +/- 1 mm

• **Mechanische Daten**
(in Pressrichtung)

Zugfestigkeit R_m min. 250 N/mm²
Streckgrenze $R_p0,2$ min. 200 N/mm²
Bruchdehnung A 5 min. 10 %
Bruchdehnung A10 min. 8 %
E-Modul ca. 70 000 N/mm²
Härte nach Brinell ca. 75 HB
Längenausdehnungskoeffizient (bei 20-100°C) $23,6 \times 10^{-6}$ 1/K

• **Mechanical data**
(in pressing direction)

Tensile strength R_m min. 250 N/mm²
Yield strength $R_p0,2$ min. 200 N/mm²
Ductile yield A 5 min. 10 %
Ductile yield A10 min. 8 %
E-module approx. 70 000 N/mm²
Brinell hardness approx. 75 HB
Linear expansion coefficient (at 20-100°C) $23,6 \times 10^{-6}$ 1/K

• **Caractéristiques mécaniques**
(sens d'extrusion)

Résistance à la traction R_m min. 250 N/mm²
Limite d'élasticité $R_p0,2$ min. 200 N/mm²
Allongement à la rupture A 5 min. 10 %
Allongement à la rupture A10 min. 8 %
Coefficient d'élasticité env. 70 000 N/mm²
Dureté selon Brinell env. 75 HB
Coefficient de dilatation thermique linéaire (de 20-100°C) $23,6 \times 10^{-6}$ 1/K

• **Oberfläche**

Matt, gebeizt E6 / Ev1
Eloxal-Schichtdicke ca. 15 µm
Eloxal-Schichthärte ca. 270-320 HV

• **Surface**

Dead-dipped E6 / Ev1
Anodizing layer thickness approx. 15 µm
Anodizing layer strength approx. 270-320 HV

• **Surface**

Décapé au mat E6 / Ev1
Epaisseur couche anodisation env. 15 µm
Dureté anodisation env. 270-320 HV

Verwindungstoleranz in Profillängsrichtung

Longitudinal torsional tolerance of profile
Tolérance de torsion dans le sens de la longueur du profilé

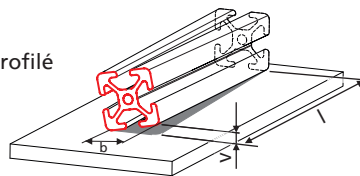

b (mm) über bis	v bei Längen l (mm)			
	1.000	2.000	4.000	6.000
20 45	1,0	1,2	1,8	2,0
45 70	1,0	1,2	1,5	2,0
75 100	1,0	1,5	2,2	3,0
125 150	1,2	1,5	2,2	3,0

Geradheitstoleranz in Profillängsrichtung

Longitudinal straightness tolerance of profile
Tolérance rectiligne dans le sens de la longueur du profilé

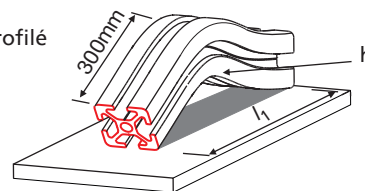

Länge l1 (mm)	h (mm)
bis 1.000	0,7
bis 2.000	1,3
bis 3.000	1,8
bis 4.000	2,2
bis 5.000	2,6
bis 6.000	3,0

Winkeltoleranz (Neigungstoleranz)

Angle tolerance (inclination tolerance)
Tolérance angulaire (tolérance inclinaison)

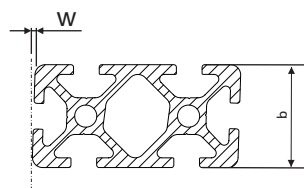

Breite b (mm)	Toleranz w (mm)
0 - 20	0,2
20 - 40	0,4
40 - 80	0,6
80 - 120	0,8
120-160	1,2

Technische Änderungen vorbehalten

Angaben sind ca. Werte, Technische Änderungen und Irrtümer vorbehalten

ALU-PROFILE PROFILES PROFILES



Konkavität

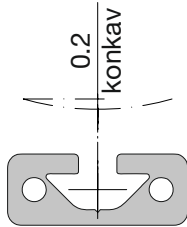

16x40S	16x80S	16x120S	16x160
■ 2.05	■ 2.05	■ 2.05	■ 2.06

2

Nut

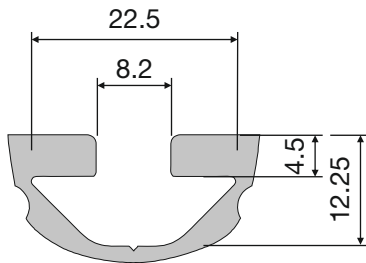

Kernloch

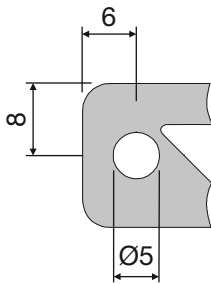

Außenkante

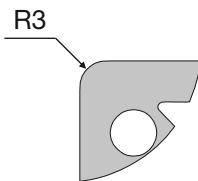

Technische Änderungen vorbehalten

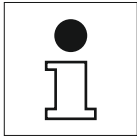

Durchbiegung der Profile
Profile deflection
Flexion des profilés

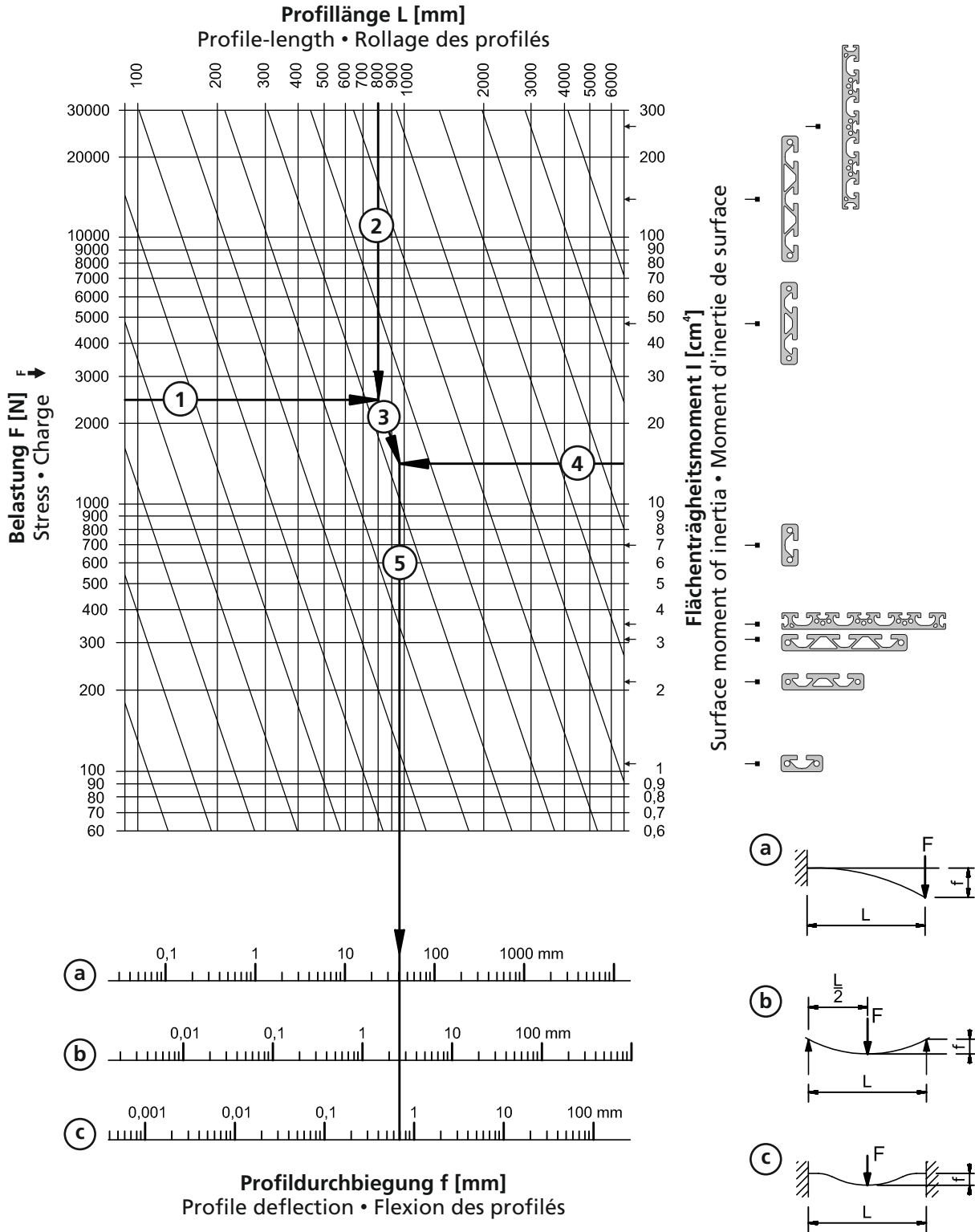

Technische Änderungen vorbehalten

ALU-PROFILE
PROFILES
PROFILES



16x40 S

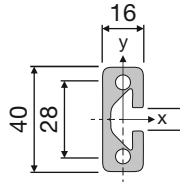

05.01045.00

M = 1,16 kg/m
 $I_x = 7,10 \text{ cm}^4$
 $W_x = 3,55 \text{ cm}^3$
 $I_y = 1,10 \text{ cm}^4$
 $W_y = 1,38 \text{ cm}^3$

PE (m)
 6 / 60 / 120



16x80 S

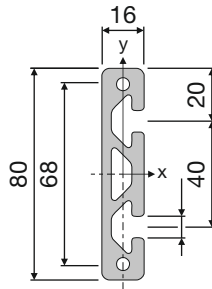
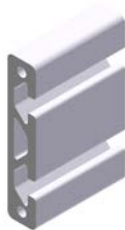

05.01813.00

M = 2,14 kg/m
 $I_x = 48,75 \text{ cm}^4$
 $W_x = 12,19 \text{ cm}^3$
 $I_y = 2,20 \text{ cm}^4$
 $W_y = 2,75 \text{ cm}^3$

PE (m)
 6 / 60 / 120

16x120 S

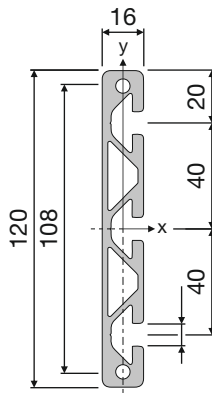
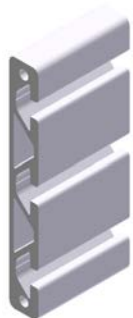

05.01806.00

M = 2,79 kg/m
 $I_x = 148,38 \text{ cm}^4$
 $W_x = 24,73 \text{ cm}^3$
 $I_y = 3,07 \text{ cm}^4$
 $W_y = 3,84 \text{ cm}^3$

PE (m)
 6 / 60 / 120

Technische Änderungen vorbehalten

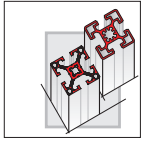

ALU-PROFILE PROFILES PROFILES



16x160

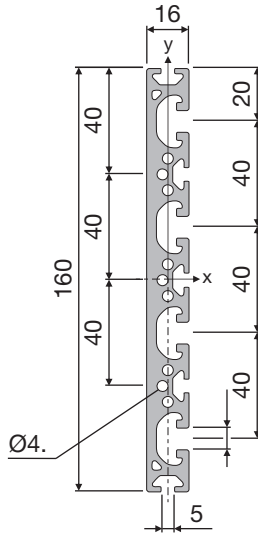
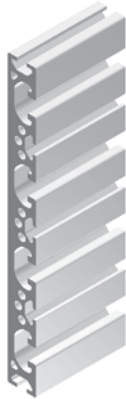

05.01805.00

M = 3,87 kg/m
 $I_x = 298,20 \text{ cm}^4$
 $W_x = 37,28 \text{ cm}^3$
 $I_y = 3,91 \text{ cm}^4$
 $W_y = 4,89 \text{ cm}^3$

PE (m)
 6 / 60 / 120

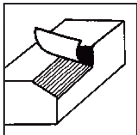

PROFILBEARBEITUNG PROFILE FINISHING USINAGE DE PROFILES

↓ ↓ ↓ ↓ ↓ ↓ ↓ ↓ ↓ ↓

16x40 16x80 16x120 16x160

		05.xxxxx.09		
VSI 7		05.xxxxx.15 ■ 3.21	VSA 14	05.xxxxx.45 ■ 3.20
VSI 7		05.xxxxx.16	VSA 14	05.xxxxx.46

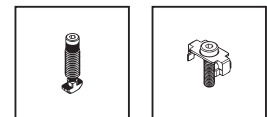

Technische Änderungen vorbehalten

ALU-PROFILE

PROFILES

PROFILES



Konkavität

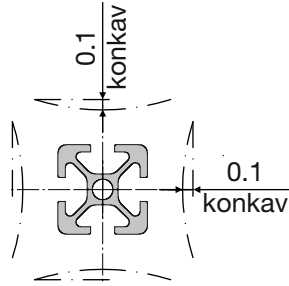

10x20

10x40



■ 2.09

■ 2.09

20x20

20x20-1N

20x20-2N90

20x20-R

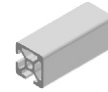
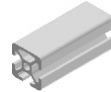

■ 2.09

■ 2.09

■ 2.10

■ 2.10

20x40

20x40-2N

20x40-3N90

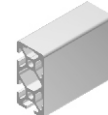
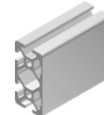
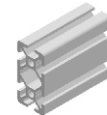
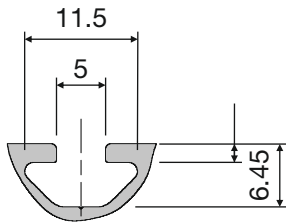

■ 2.10

■ 2.10

■ 2.11

Kernloch

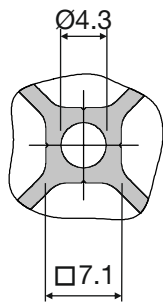

20x60

20x80

40x40

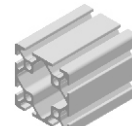
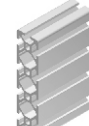
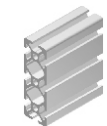

■ 2.11

■ 2.11

■ 2.11

Außenkante

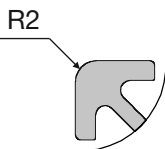

2

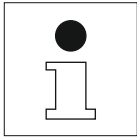

Durchbiegung der Profile
Profile deflection
Flexion des profilés

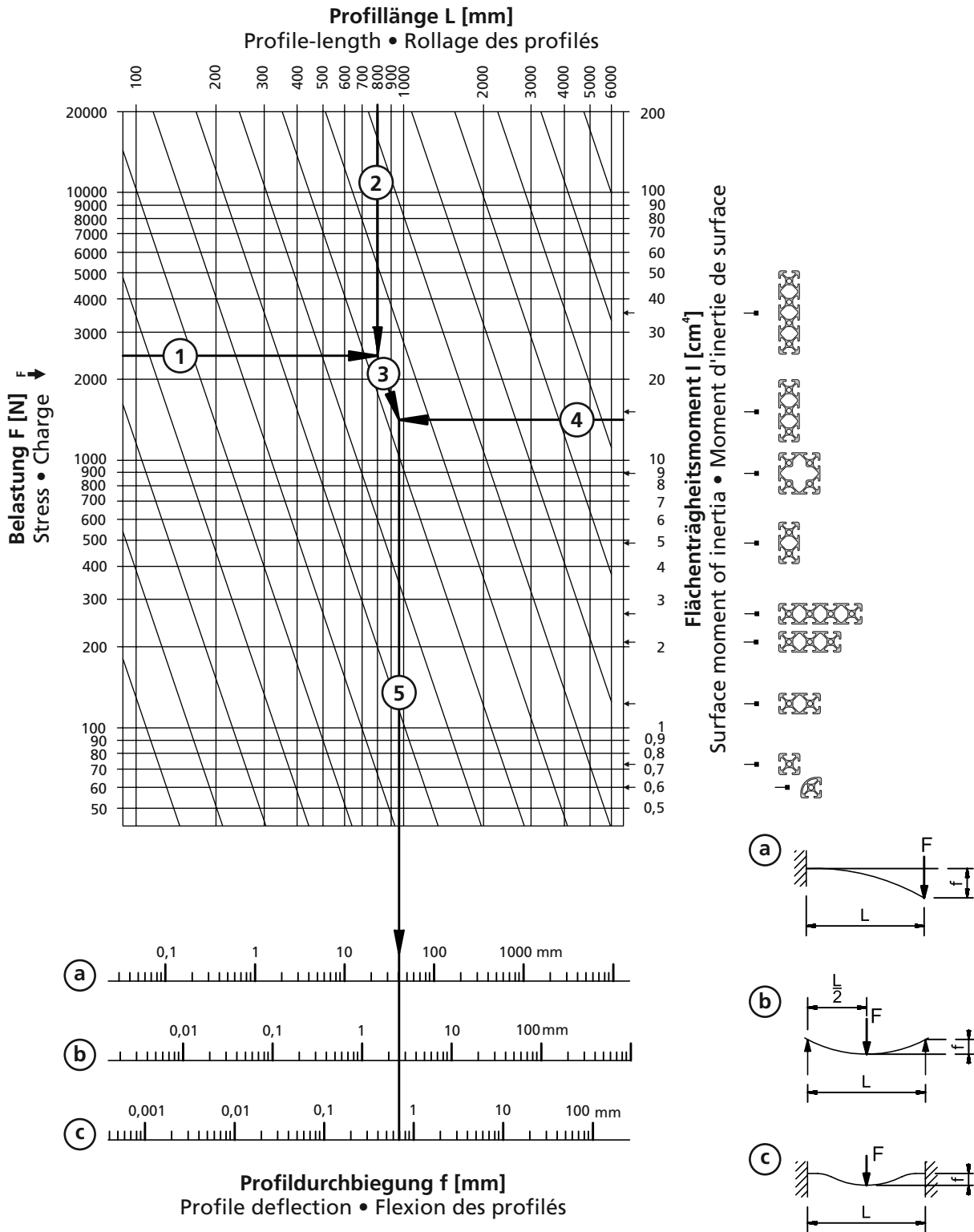

Technische Änderungen vorbehalten

ALU-PROFILE
PROFILES
PROFILES



10x20

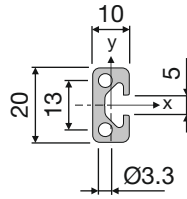

05.01602.00

M = 0,35 kg/m
 $I_x = 0,53 \text{ cm}^4$
 $W_x = 0,53 \text{ cm}^3$
 $I_y = 0,13 \text{ cm}^4$
 $W_y = 0,26 \text{ cm}^3$
 PE (m)
 6

10x40

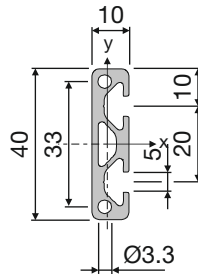
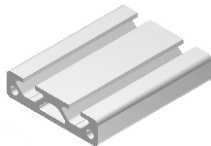

05.01603.00

M = 0,63 kg/m
 $I_x = 3,56 \text{ cm}^4$
 $W_x = 7,12 \text{ cm}^3$
 $I_y = 0,35 \text{ cm}^4$
 $W_y = 0,18 \text{ cm}^3$
 PE (m)
 6

20x20

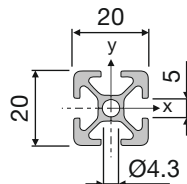
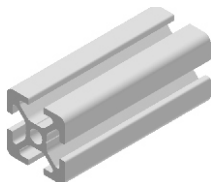

05.01605.00

M = 0,48 kg/m
 $I_x = 0,74 \text{ cm}^4$
 $W_x = 0,74 \text{ cm}^3$
 $I_y = 0,74 \text{ cm}^4$
 $W_y = 0,74 \text{ cm}^3$
 PE (m)
 6 / 96 / 192

20x20-1N

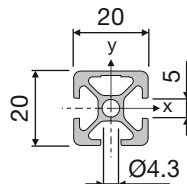
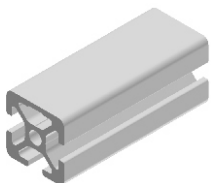

05.01645.00

M = 0,50 kg/m
 $I_x = 0,74 \text{ cm}^4$
 $W_x = 0,74 \text{ cm}^3$
 $I_y = 0,80 \text{ cm}^4$
 $W_y = 0,80 \text{ cm}^3$
 PE (m)
 6 / 96 / 192

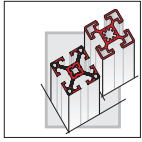

ALU-PROFILE
PROFILES
PROFILES



20x20-2N90

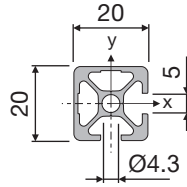
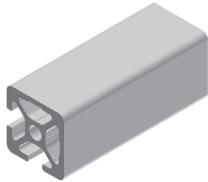

05.01646.00

M = 0,52 kg/m
 $I_x = 0,80 \text{ cm}^4$
 $W_x = 0,80 \text{ cm}^3$
 $I_y = 0,80 \text{ cm}^4$
 $W_y = 0,80 \text{ cm}^3$
 PE (m)
 6 / 96 / 192

20x20-R

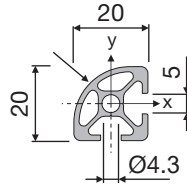
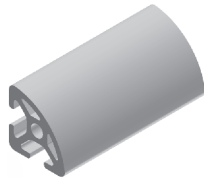

05.01024.00

M = 0,47 kg/m
 $I_x = 0,66 \text{ cm}^4$
 $W_x = 0,66 \text{ cm}^3$
 $I_y = 0,66 \text{ cm}^4$
 $W_y = 0,66 \text{ cm}^3$
 PE (m)
 6

20x40

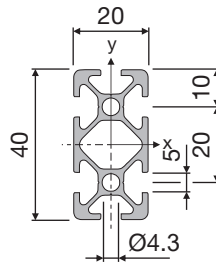
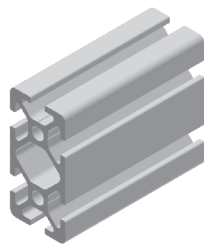

05.01606.00

M = 0,85 kg/m
 $I_x = 5,01 \text{ cm}^4$
 $W_x = 2,51 \text{ cm}^3$
 $I_y = 1,36 \text{ cm}^4$
 $W_y = 1,36 \text{ cm}^3$
 PE (m)
 6 / 96 / 192

20x40-2N

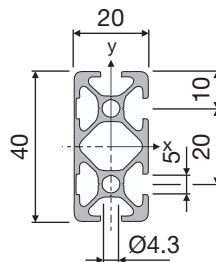
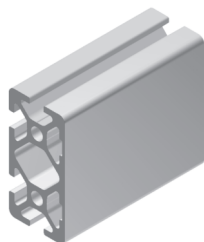

05.01658.00

M = 0,89 kg/m
 $I_x = 5,27 \text{ cm}^4$
 $W_x = 2,64 \text{ cm}^3$
 $I_y = 1,44 \text{ cm}^4$
 $W_y = 1,44 \text{ cm}^3$
 PE (m)
 3

Technische Änderungen vorbehalten

ALU-PROFILE
PROFILES
PROFILES



20x40-3N90

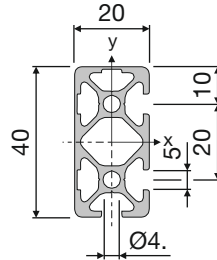
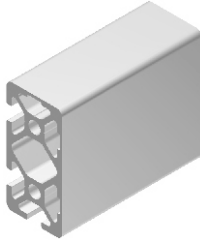

05.01659.00

M = 0,89 kg/m
 $I_x = 5,27 \text{ cm}^4$
 $W_x = 2,64 \text{ cm}^3$
 $I_y = 1,44 \text{ cm}^4$
 $W_y = 1,44 \text{ cm}^3$
 PE (m)
 6 / 96 / 192

20x60

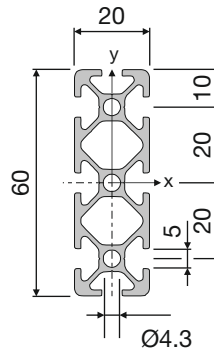
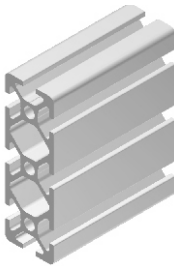

05.01663.00

M = 1,24 kg/m
 $I_x = 16,09 \text{ cm}^4$
 $W_x = 5,36 \text{ cm}^3$
 $I_y = 2,06 \text{ cm}^4$
 $W_y = 2,06 \text{ cm}^3$
 PE (m)
 6 / 24

20x80

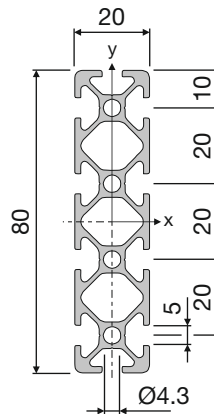
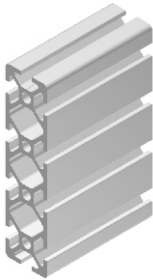

05.01664.00

M = 1,62 kg/m
 $I_x = 36,08 \text{ cm}^4$
 $W_x = 9,02 \text{ cm}^3$
 $I_y = 2,72 \text{ cm}^4$
 $W_y = 2,72 \text{ cm}^3$
 PE (m)
 6 / 24

40x40

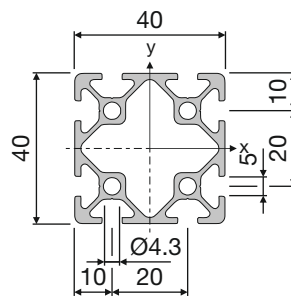
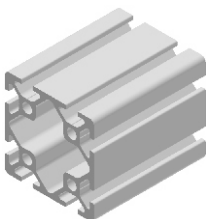

05.01607.00

M = 1,33 kg/m
 $I_x = 8,92 \text{ cm}^4$
 $W_x = 4,46 \text{ cm}^3$
 $I_y = 8,92 \text{ cm}^4$
 $W_y = 4,46 \text{ cm}^3$
 PE (m)
 6

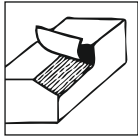

PROFILBEARBEITUNG

PROFILE FINISHING

USINAGE DE PROFILES

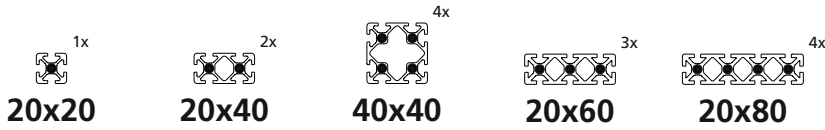

		05.xxxxx.09
M5x20		05.xxxxx.10
M5x20		05.xxxxx.11

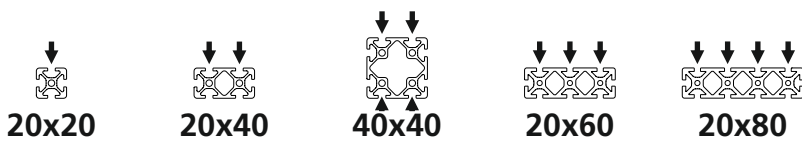

VSI 4.3		05.xxxxx.15	■ 3.21	VSA 10		05.xxxxx.45	■ 3.16
VSI 4.3		VSI 4.3	05.xxxxx.16	VSA 10		VSA 10	05.xxxxx.46
UNI		05.xxxxx.40	■ 3.11				
UNI		UNI	05.xxxxx.41				
GV7,5		05.xxxxx.30	■ 3.02				
GV7,5		GV7,5	05.xxxxx.31				

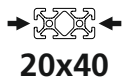

UNI		05.xxxxx.43	■ 3.11
UNI		UNI	05.xxxxx.44

Technische Änderungen vorbehalten

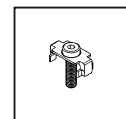
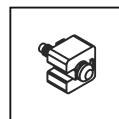
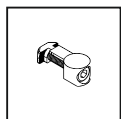
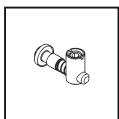

ALU-PROFILE PROFILES PROFILES



Konkavität

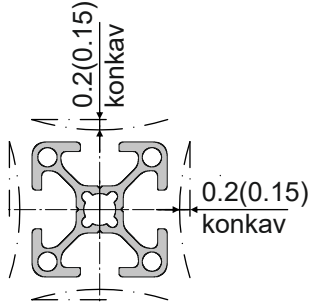

30x30

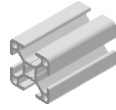

■ 2.15

30x30-1N

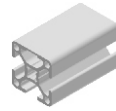

■ 2.15

30x30-2N90

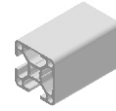

■ 2.15

30x30-R

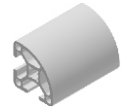

■ 2.15

30x45

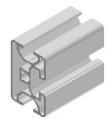

■ 2.15

30x60

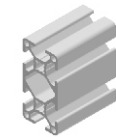

■ 2.16

30x60-2N

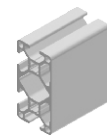

■ 2.16

30x60-3N90

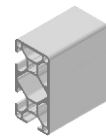

■ 2.16

Nut

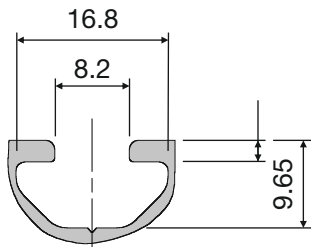

30x30KL

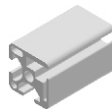

➔ ■ 2.17

30x30KL-180°

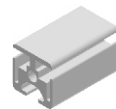

➔ ■ 2.17

Kernloch

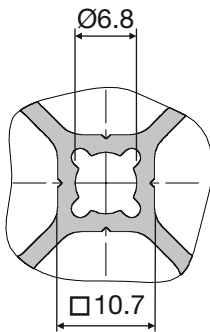

Außenkante

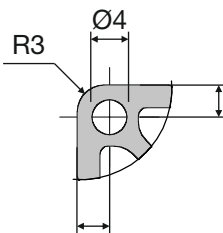

2

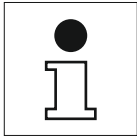

Durchbiegung der Profile
Profile deflection
Flexion des profilés

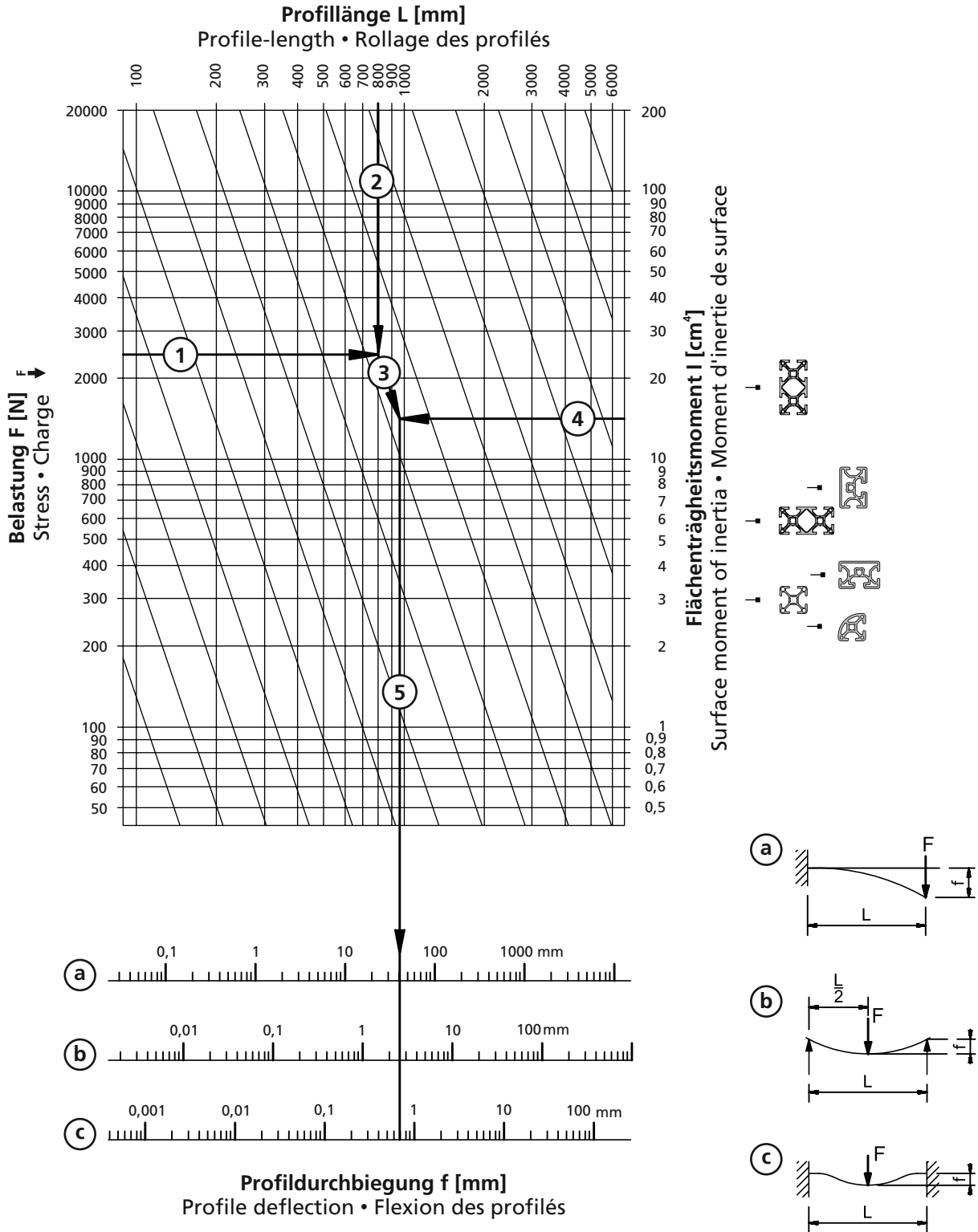

Technische Änderungen vorbehalten

ALU-PROFILE
PROFILES
PROFILES



30x30

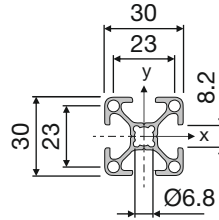
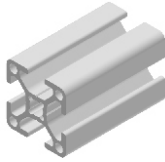

05.01025.00

M = 0,81 kg/m
 $I_x = 2,78 \text{ cm}^4$
 $W_x = 1,85 \text{ cm}^3$
 $I_y = 2,78 \text{ cm}^4$
 $W_y = 1,85 \text{ cm}^3$
 PE (m)
 6 / 72 / 144

30x30-1N

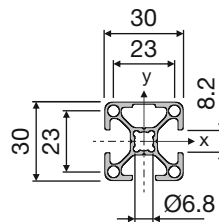
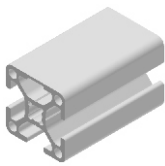

05.01915.00

M = 0,84 kg/m
 $I_x = 2,95 \text{ cm}^4$
 $W_x = 1,97 \text{ cm}^3$
 $I_y = 2,78 \text{ cm}^4$
 $W_y = 1,85 \text{ cm}^3$
 PE (m)
 6 / 72 / 144

30x30-2N90

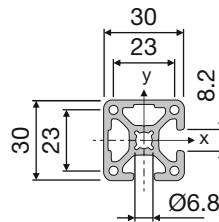
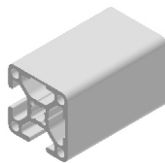

05.01916.00

M = 0,86 kg/m
 $I_x = 2,96 \text{ cm}^4$
 $W_x = 1,97 \text{ cm}^3$
 $I_y = 2,96 \text{ cm}^4$
 $W_y = 1,97 \text{ cm}^3$
 PE (m)
 6 / 72 / 144

30x30-R

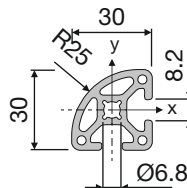
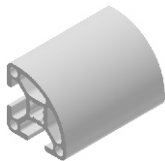

05.01925.00

M = 0,80 kg/m
 $I_x = 2,40 \text{ cm}^4$
 $W_x = 1,60 \text{ cm}^3$
 $I_y = 2,40 \text{ cm}^4$
 $W_y = 1,60 \text{ cm}^3$
 PE (m)
 6 / 72 / 144

30x45

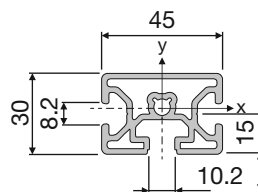
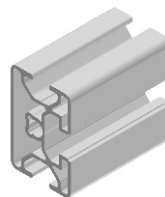

05.01923.00

M = 1,05 kg/m
 $I_x = 7,97 \text{ cm}^4$
 $W_x = 3,54 \text{ cm}^3$
 $I_y = 3,75 \text{ cm}^4$
 $W_y = 2,51 \text{ cm}^3$
 PE (m)
 6 / 24 / 48 / 72

Technische Änderungen vorbehalten

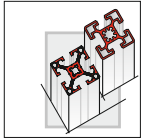

ALU-PROFILE
PROFILES
PROFILES



30x60

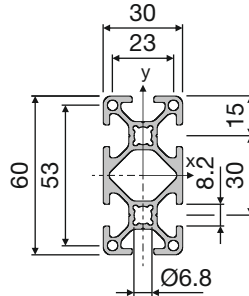
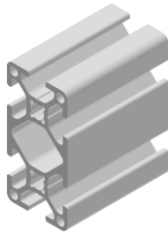

05.01924.00

M = 1,50 kg/m
 $I_x = 19,10 \text{ cm}^4$
 $W_x = 6,60 \text{ cm}^3$
 $I_y = 5,64 \text{ cm}^4$
 $W_y = 3,76 \text{ cm}^3$

PE (m)
 6 / 36 / 72 / 108

30x60-2N

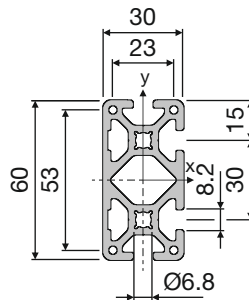
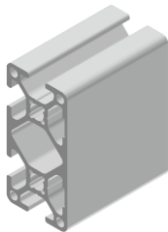

05.01933.00

M = 1,61 kg/m
 $I_x = 20,48 \text{ cm}^4$
 $W_x = 6,83 \text{ cm}^3$
 $I_y = 6,07 \text{ cm}^4$
 $W_y = 4,05 \text{ cm}^3$

PE (m)
 3

30x60-3N90

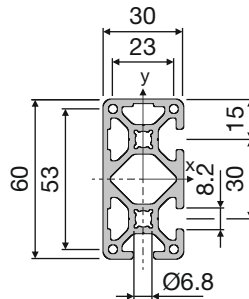
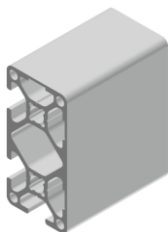

05.01928.00

M = 1,61 kg/m
 $I_x = 20,48 \text{ cm}^4$
 $W_x = 6,83 \text{ cm}^3$
 $I_y = 6,07 \text{ cm}^4$
 $W_y = 4,05 \text{ cm}^3$

PE (m)
 6 / 36 / 72 / 108

Technische Änderungen vorbehalten

KLEMMPROFILE

CLAMPING PROFILES

PROFILE DE SERRAGE



30x30 KL

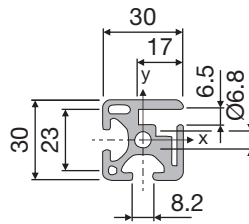
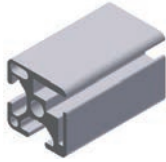

05.01919.00

M = 1,04 kg/m
 $I_x = 3,40 \text{ cm}^4$
 $W_x = 2,27 \text{ cm}^3$
 $I_y = 3,10 \text{ cm}^4$
 $W_y = 2,07 \text{ cm}^3$

PE (m)
 6 / 72 / 144

Klemmleiste und Schrauben nicht im Lieferumfang enthalten
 Clamping strips and screws are not included
 Baguette et vis ne sont pas inclus

30x30 KL-180°

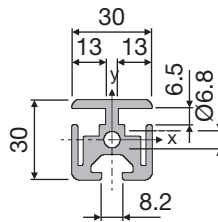
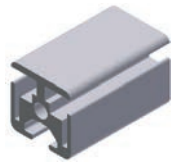

05.01921.00

M = 1,16 kg/m
 $I_x = 3,61 \text{ cm}^4$
 $W_x = 2,41 \text{ cm}^3$
 $I_y = 3,45 \text{ cm}^4$
 $W_y = 2,30 \text{ cm}^3$

PE (m)
 6 / 72 / 144

Klemmleiste und Schrauben nicht im Lieferumfang enthalten
 Clamping strips and screws are not included
 Baguette et vis ne sont pas inclus

Klemmleiste

Clamping strips · Baguette

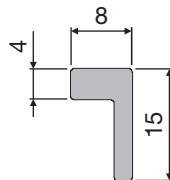

05.01922.00

PE (m)
 6

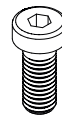

99.00095.00

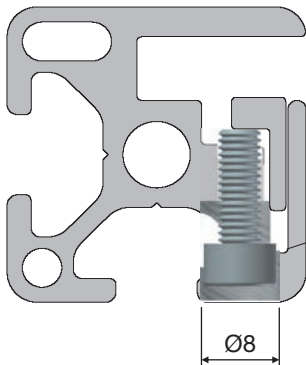

M4x12, DIN 7984
 Bitte separat bestellen
 Please order separately
 Commander séparément

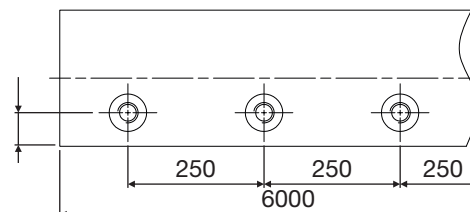

Bohrungen bereits im Profil vorhanden
 Holes already provided in profiles
 Profilés déjà usinés

Technische Änderungen vorbehalten

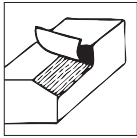

PROFILBEARBEITUNG

PROFILE FINISHING

USINAGE DE PROFILES

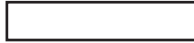
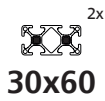
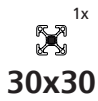

05.xxxxx.09

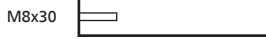

05.xxxxx.10



05.xxxxx.11

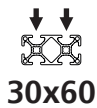

05.xxxxx.15 ■ 3.21



05.xxxxx.40 ■ 3.11



05.xxxxx.16



05.xxxxx.41



05.xxxxx.25 ■ 3.06



05.xxxxx.45 ■ 3.20



05.xxxxx.26



05.xxxxx.46



05.xxxxx.30 ■ 3.02

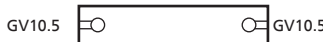

05.xxxxx.31

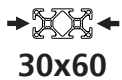

05.xxxxx.85 ■ 3.06



05.xxxxx.43 ■ 3.11

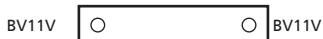

05.xxxxx.86

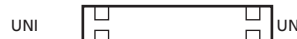

05.xxxxx.44

Technische Änderungen vorbehalten

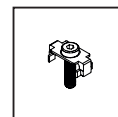
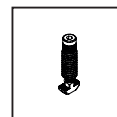
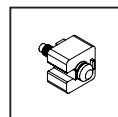
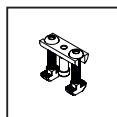
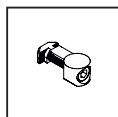
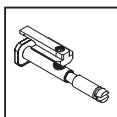
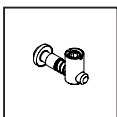

Konkavität

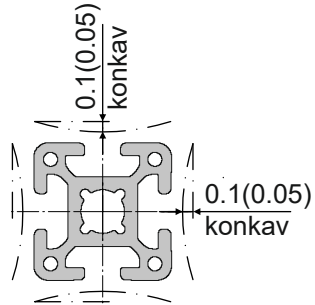

30x30-10K



■ 2.21

30x60-10K

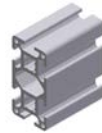

■ 2.21

60x60-10K

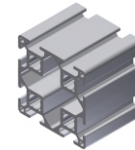

■ 2.21

2

Nut

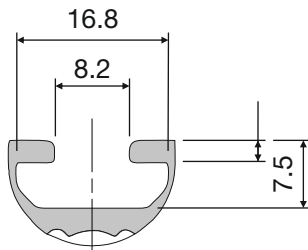

Kernloch

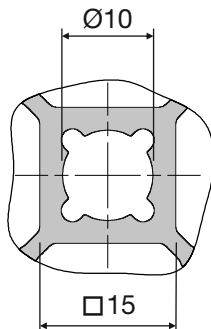

Außenkante

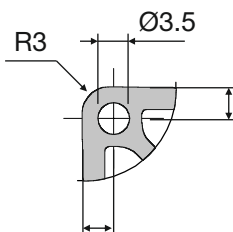

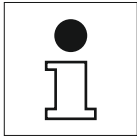

Durchbiegung der Profile
Profile deflection
Flexion des profilés

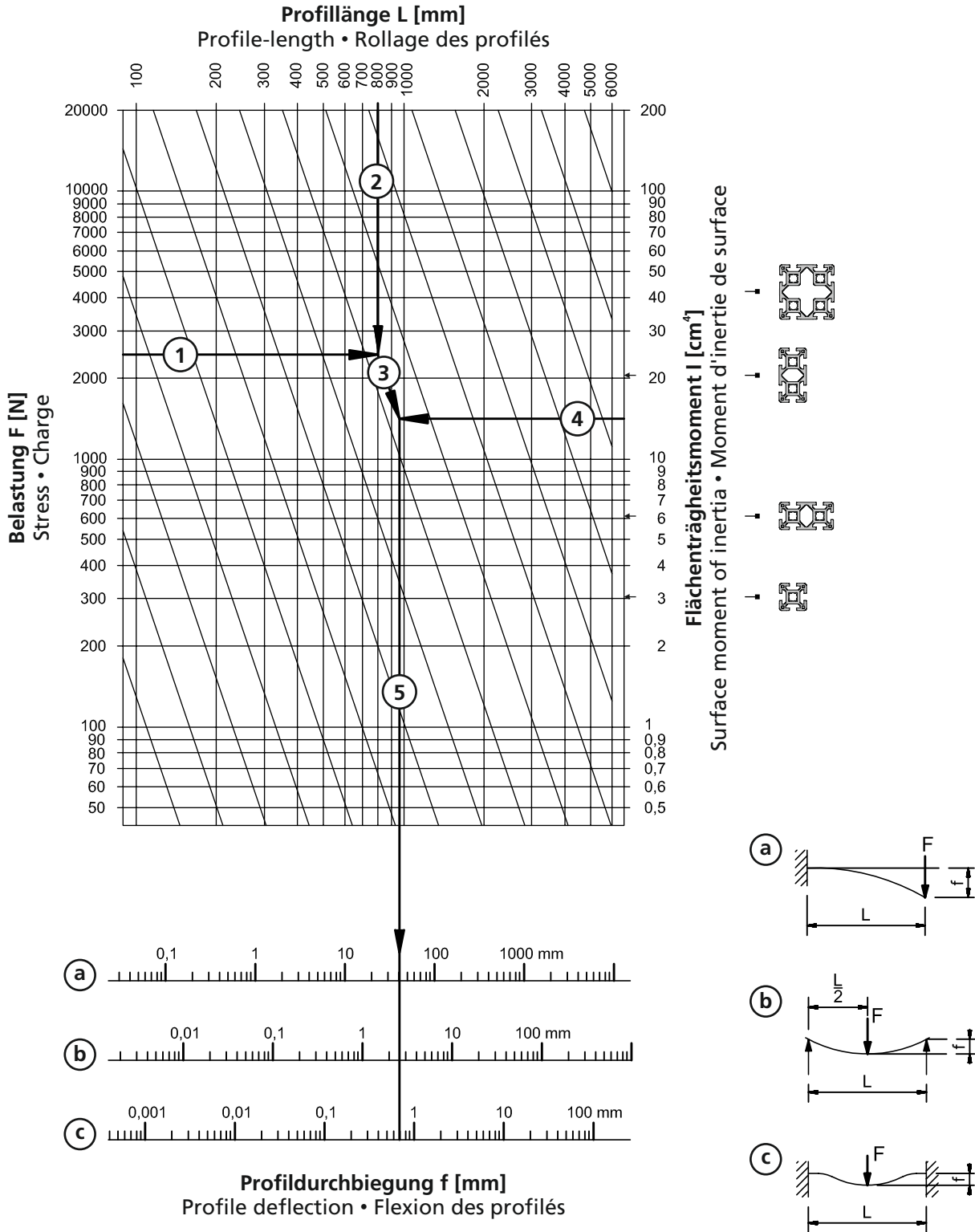

Technische Änderungen vorbehalten

30x30-10K

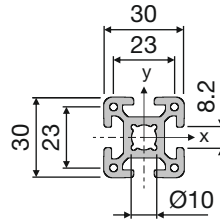

05.01926.00

M = 0,97 kg/m
 $I_x = 3,17 \text{ cm}^4$
 $W_x = 2,11 \text{ cm}^3$
 $I_y = 3,17 \text{ cm}^4$
 $W_y = 2,11 \text{ cm}^3$
 PE (m)
 6 / 72 / 144

30x60-10K

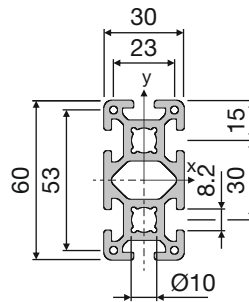
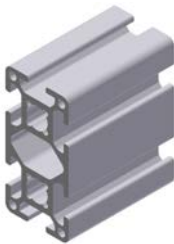

05.01927.00

M = 1,81 kg/m
 $I_x = 22,55 \text{ cm}^4$
 $W_x = 7,52 \text{ cm}^3$
 $I_y = 6,33 \text{ cm}^4$
 $W_y = 4,22 \text{ cm}^3$
 PE (m)
 6 / 36 / 72 / 108

60x60-10K

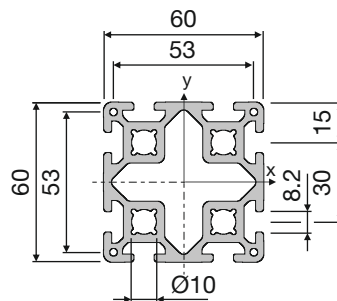
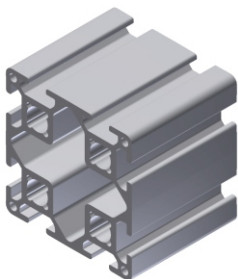

05.01960.00

M = 3,00 kg/m
 $I_x = 42,67 \text{ cm}^4$
 $W_x = 14,22 \text{ cm}^3$
 $I_y = 42,67 \text{ cm}^4$
 $W_y = 14,22 \text{ cm}^3$
 PE (m)
 6 / 36 / 72 / 108

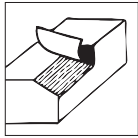

PROFILBEARBEITUNG

PROFILE FINISHING

USINAGE DE PROFILES

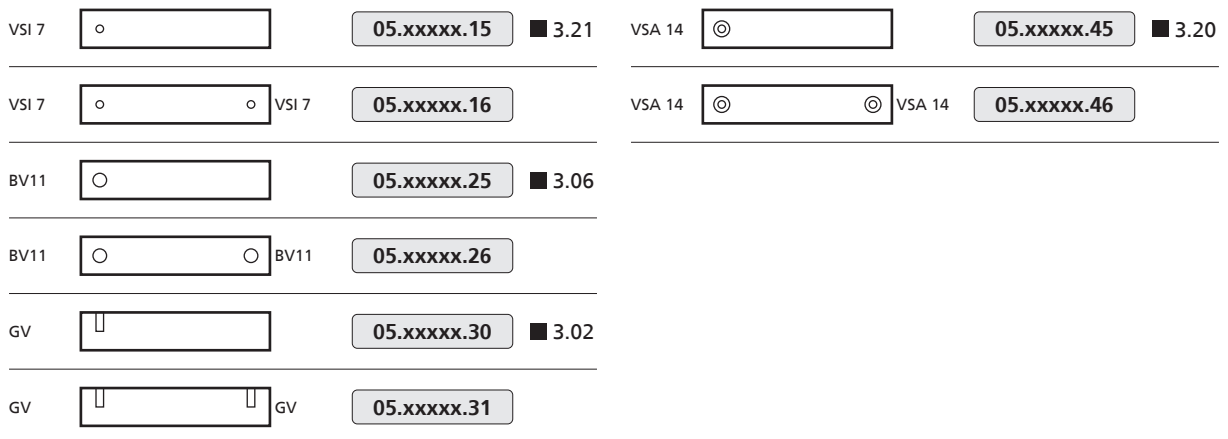
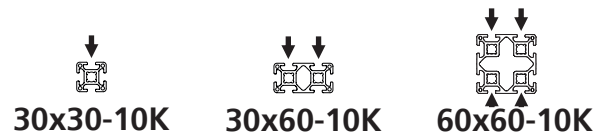
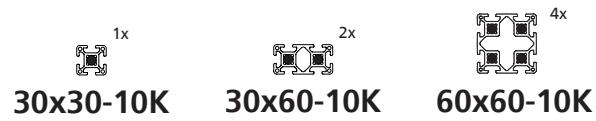

30x60-10K

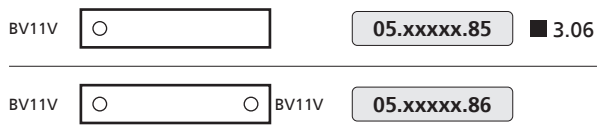

Technische Änderungen vorbehalten

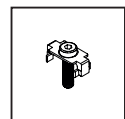
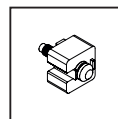
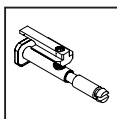
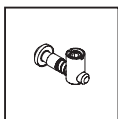



Konkavität

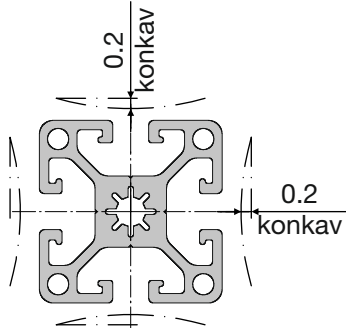

40x40EL-1.4



■ 2.25

40x40L-1.55



■ 2.25

40x40L-1N



■ 2.25

40x40L-2N90

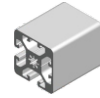

■ 2.25

40x40L-2N180

40x80EL-2.45

40x80L-2.65

40x80L-2N

Nut

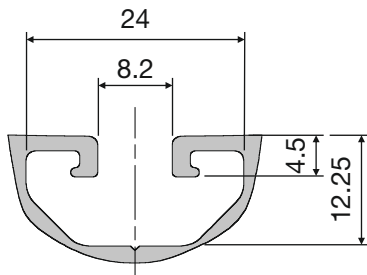

■ 2.25

40x80L-3N

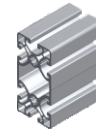

■ 2.26

40x120L

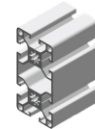

■ 2.26

80x80L

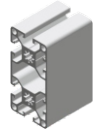

■ 2.26

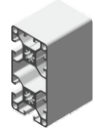

■ 2.27

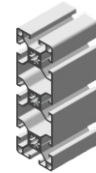

■ 2.27

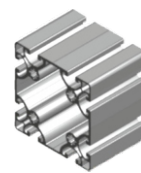

■ 2.27

Kernloch

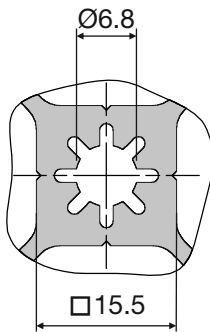

Außenkante

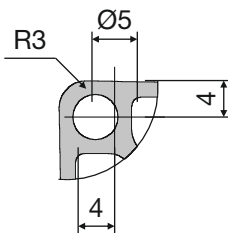

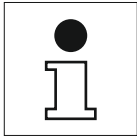

Durchbiegung der Profile
Profile deflection
Flexion des profilés

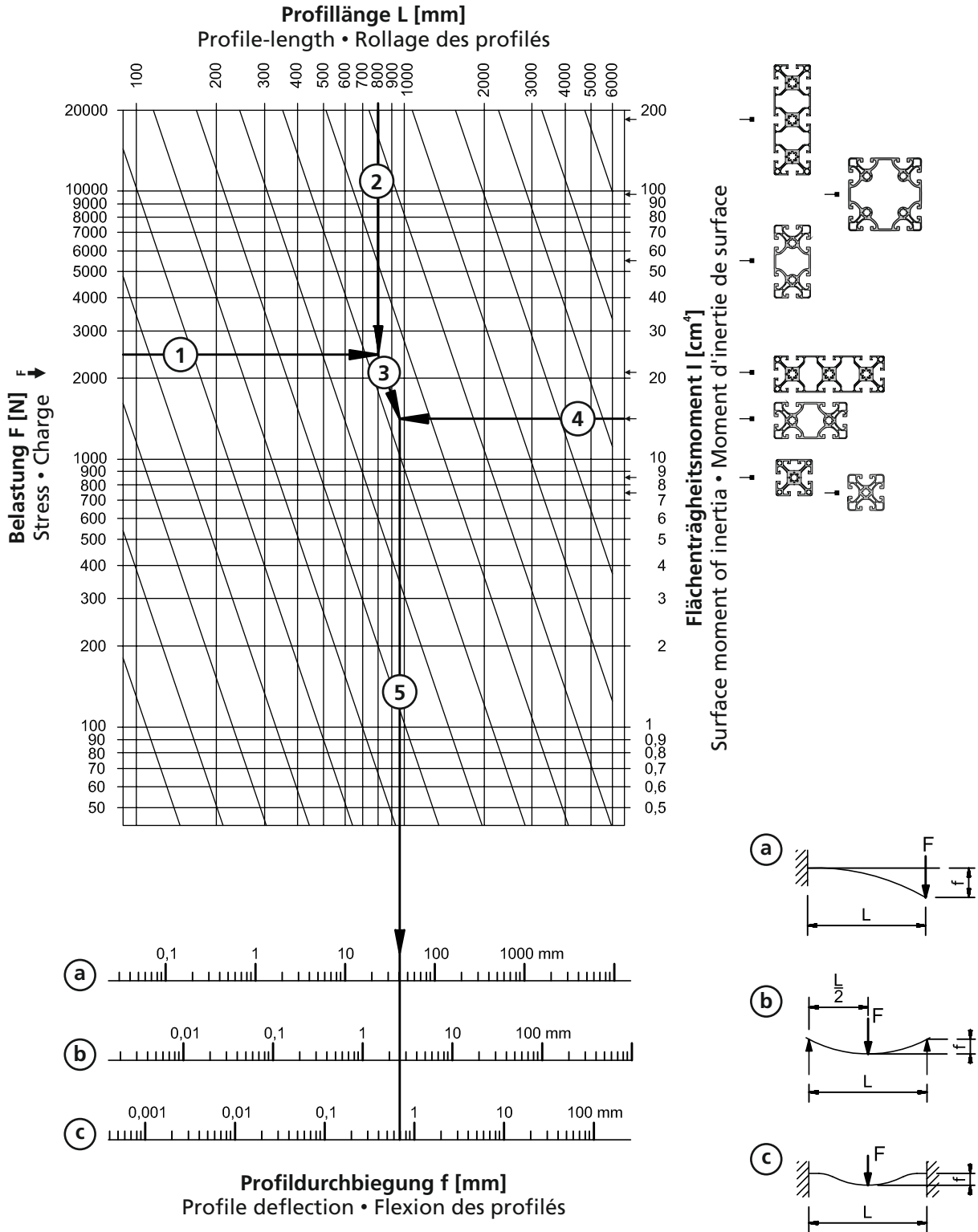

ALU-PROFILE PROFILES PROFILES



40x40 EL-1.4

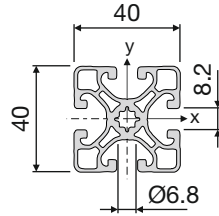
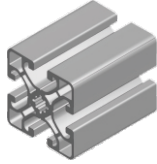

05.02163.00

M = 1,37 kg/m
 $I_x = 7,42 \text{ cm}^4$
 $W_x = 3,71 \text{ cm}^3$
 $I_y = 7,42 \text{ cm}^4$
 $W_y = 3,71 \text{ cm}^3$

PE (m)
 6 / 48 / 96 / 144

40x40 L-1.55

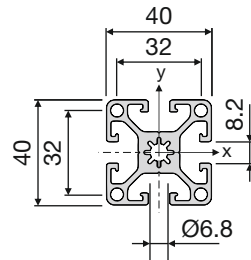
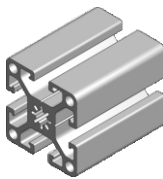

05.01035.00

M = 1,53 kg/m
 $I_x = 8,40 \text{ cm}^4$
 $W_x = 4,20 \text{ cm}^3$
 $I_y = 8,40 \text{ cm}^4$
 $W_y = 4,20 \text{ cm}^3$

PE (m)
 6 / 48 / 96 / 144

40x40 L-1N

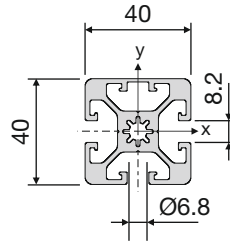
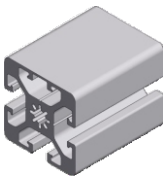

05.01130.00

M = 1,56 kg/m
 $I_x = 8,73 \text{ cm}^4$
 $W_x = 4,36 \text{ cm}^3$
 $I_y = 8,41 \text{ cm}^4$
 $W_y = 4,21 \text{ cm}^3$

PE (m)
 6 / 48 / 96 / 144

40x40 L-2N90

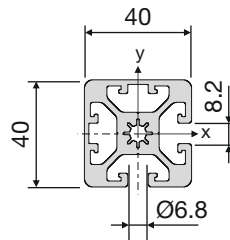
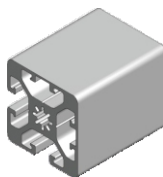

05.01131.00

M = 1,59 kg/m
 $I_x = 8,74 \text{ cm}^4$
 $W_x = 4,37 \text{ cm}^3$
 $I_y = 8,73 \text{ cm}^4$
 $W_y = 4,36 \text{ cm}^3$

PE (m)
 6 / 48 / 96 / 144

40x40 L-2N180

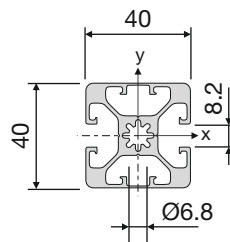
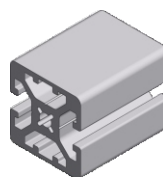

05.01132.00

M = 1,59 kg/m
 $I_x = 9,06 \text{ cm}^4$
 $W_x = 4,53 \text{ cm}^3$
 $I_y = 8,42 \text{ cm}^4$
 $W_y = 4,21 \text{ cm}^3$

PE (m)
 6 / 48 / 96 / 144

2

Technische Änderungen vorbehalten

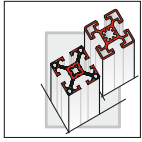

ALU-PROFILE
PROFILES
PROFILES



40x80 EL-2.45

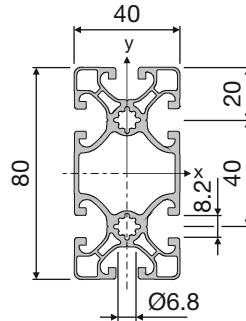
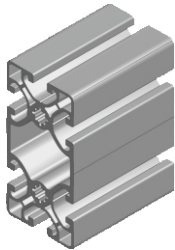

05.02164.00

M = 2,41 kg/m
 $I_x = 55,44 \text{ cm}^4$
 $W_x = 13,80 \text{ cm}^3$
 $I_y = 14,90 \text{ cm}^4$
 $W_y = 7,45 \text{ cm}^3$

PE (m)
 6 / 24 / 48 / 72

40x80 L-2.65

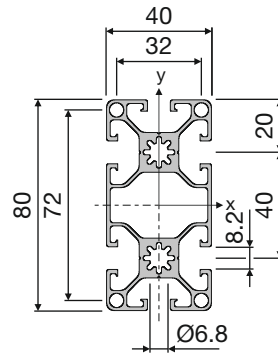
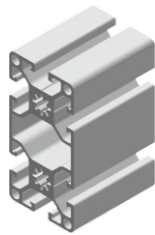

05.01036.00

M = 2,58 kg/m
 $I_x = 61,26 \text{ cm}^4$
 $W_x = 15,32 \text{ cm}^3$
 $I_y = 14,87 \text{ cm}^4$
 $W_y = 7,44 \text{ cm}^3$

PE (m)
 6 / 24 / 48 / 72

40x80 L-2N

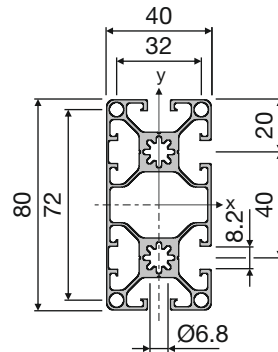
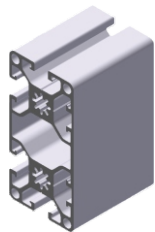

05.01037.00

M = 2,63 kg/m
 $I_x = 61,97 \text{ cm}^4$
 $W_x = 15,49 \text{ cm}^3$
 $I_y = 15,52 \text{ cm}^4$
 $W_y = 7,76 \text{ cm}^3$

PE (m)
 6 / 24 / 48 / 72

Technische Änderungen vorbehalten

ALU-PROFILE
PROFILES
PROFILES



40x80 L-3N

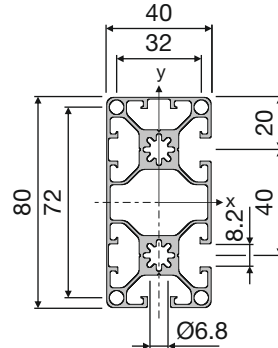
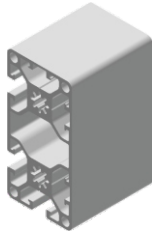

05.01038.00

M = 2,65 kg/m
 $I_x = 63,33 \text{ cm}^4$
 $W_x = 15,83 \text{ cm}^3$
 $I_y = 15,53 \text{ cm}^4$
 $W_y = 7,77 \text{ cm}^3$

PE (m)
 6 / 24 / 48 / 72



40x120 L

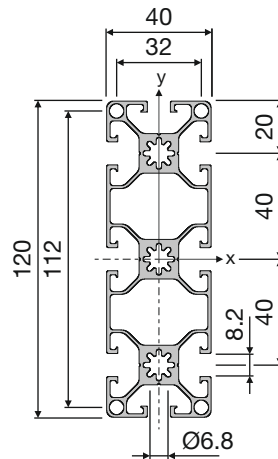
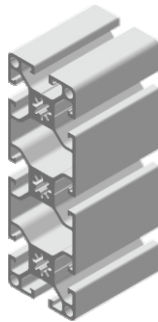

05.01046.00

M = 3,66 kg/m
 $I_x = 190,62 \text{ cm}^4$
 $W_x = 31,77 \text{ cm}^3$
 $I_y = 21,32 \text{ cm}^4$
 $W_y = 10,36 \text{ cm}^3$

PE (m)
 6 / 24 / 48 / 72

80x80 L

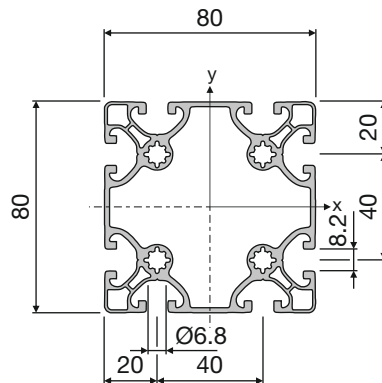
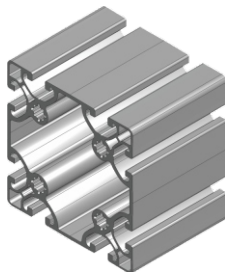

05.02165.00

M = 3,62 kg/m
 $I_x = 99,47 \text{ cm}^4$
 $W_x = 24,90 \text{ cm}^3$
 $I_y = 99,47 \text{ cm}^4$
 $W_y = 24,90 \text{ cm}^3$

PE (m)
 6 / 24 / 48 / 72

Technische Änderungen vorbehalten

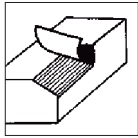

PROFILBEARBEITUNG

PROFILE FINISHING

USINAGE DE PROFILES



40x40	40x80	40x120	80x80

	05.xxxxx.09		05.xxxxx.10		05.xxxxx.11		05.xxxxx.12
M8x40		M8x40		M8x40		M12x60	
	05.xxxxx.11		05.xxxxx.12		05.xxxxx.13		
M8x40		M8x40		M12x60		M12x60	

40x40	40x80	40x120	80x80

VSI 7		05.xxxxx.15	■ 3.21	UNI		05.xxxxx.40	■ 3.11
VSI 7		05.xxxxx.16		UNI		05.xxxxx.41	
BV14		05.xxxxx.25	■ 3.06	VSA 14		05.xxxxx.45	■ 3.20
BV14		05.xxxxx.26		VSA 14		05.xxxxx.46	
GV14		05.xxxxx.30	■ 3.02				
GV14		05.xxxxx.31					
AGV		05.xxxxx.35	■ 3.04				
AGV		05.xxxxx.36					

40x80

BV14V		05.xxxxx.85	■ 3.06	UNI		05.xxxxx.43	■ 3.11
BV14V		05.xxxxx.86		UNI		05.xxxxx.44	
AGV		05.xxxxx.83	■ 3.04				
AGV		05.xxxxx.84					

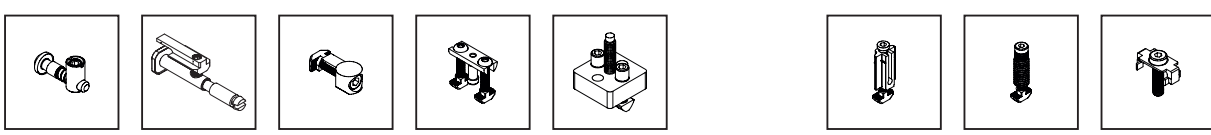

Technische Änderungen vorbehalten

ALU-PROFILE PROFILES PROFILES



Konkavität

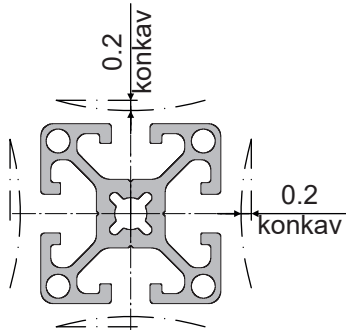

Nut

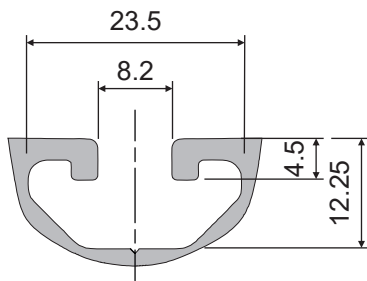

Kernloch

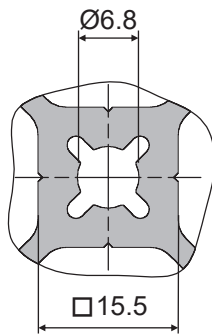

Außenkante

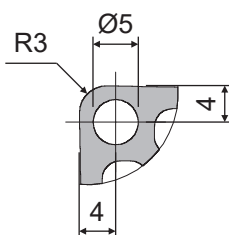

40x40N	40x40-1N	40x40-2N90	40x40-2N180
■ 2.31	■ 2.31	■ 2.31	■ 2.31
40x40N-45°	40x40N-R		
■ 2.32	■ 2.32		
40x80N	40x120N	40x160N	40x160N-4N
■ 2.32	■ 2.32	■ 2.33	■ 2.33
80x80N	80x80N-2N	80x80N-4N90	
■ 2.34	■ 2.34	■ 2.34	
80x120N	80x160N	40x40 KL	40x40 KL-180°
■ 2.35	■ 2.35	■ 2.37	■ 2.37
40R80-30°	40R80-45°	40R80-60°	40R80-90°
■ 2.36	■ 2.36	■ 2.36	■ 2.36

2

Technische Änderungen vorbehalten

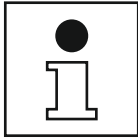

Durchbiegung der Profile
Profile deflection
Flexion des profilés

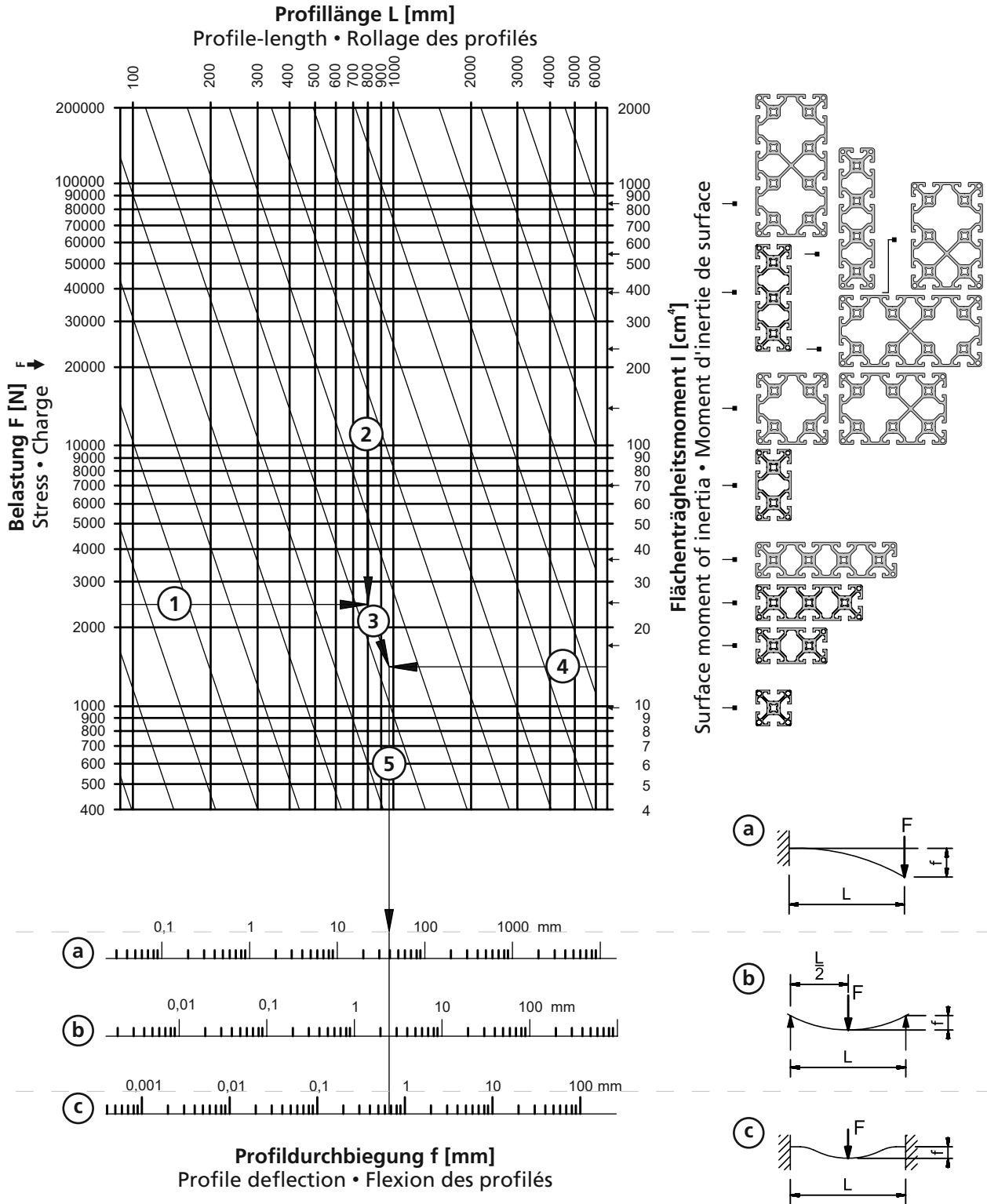

Technische Änderungen vorbehalten

ALU-PROFILE
PROFILES
PROFILES



40x40 N

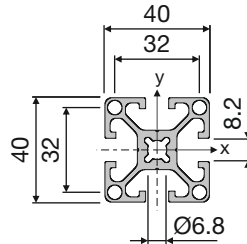
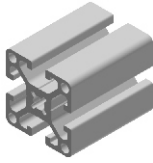

05.01002.00

M = 1,72 kg/m
 $I_x = 9,66 \text{ cm}^4$
 $W_x = 4,83 \text{ cm}^3$
 $I_y = 9,66 \text{ cm}^4$
 $W_y = 4,83 \text{ cm}^3$

PE (m)
 6 / 48 / 96 / 144

40x40 N-1N

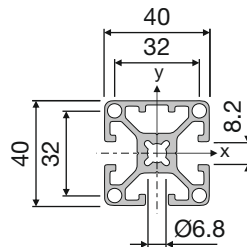
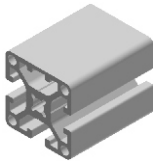

05.01026.00

M = 1,75 kg/m
 $I_x = 10,06 \text{ cm}^4$
 $W_x = 5,03 \text{ cm}^3$
 $I_y = 9,52 \text{ cm}^4$
 $W_y = 4,76 \text{ cm}^3$

PE (m)
 6 / 48 / 96 / 144

40x40 N-2N90

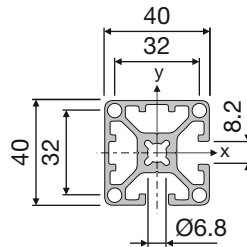
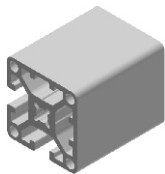

05.01027.00

M = 1,79 kg/m
 $I_x = 10,07 \text{ cm}^4$
 $W_x = 5,04 \text{ cm}^3$
 $I_y = 10,07 \text{ cm}^4$
 $W_y = 5,04 \text{ cm}^3$

PE (m)
 6 / 48 / 96 / 144

40x40 N-2N180

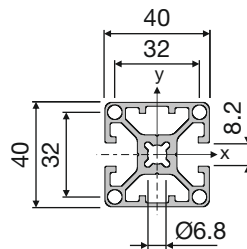
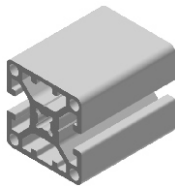

05.01028.00

M = 1,79 kg/m
 $I_x = 10,61 \text{ cm}^4$
 $W_x = 5,31 \text{ cm}^3$
 $I_y = 9,53 \text{ cm}^4$
 $W_y = 4,77 \text{ cm}^3$

PE (m)
 6 / 48 / 96 / 144

40x40 N-3N

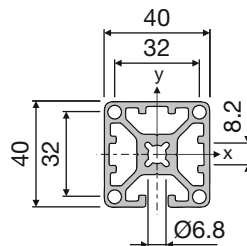
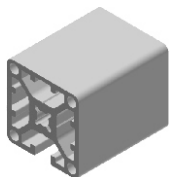

05.01536.00

M = 1,83 kg/m
 $I_x = 10,62 \text{ cm}^4$
 $W_x = 5,31 \text{ cm}^3$
 $I_y = 10,66 \text{ cm}^4$
 $W_y = 5,33 \text{ cm}^3$

PE (m)
 6 / 48 / 96 / 144

2

Technische Änderungen vorbehalten

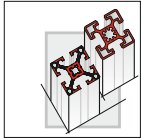

ALU-PROFILE

PROFILES

PROFILES



40x40 N-45°

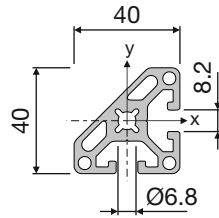
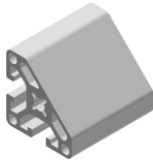

05.01029.00

M = 1,51 kg/m
 $I_x = 7,50 \text{ cm}^4$
 $W_x = 3,75 \text{ cm}^3$
 $I_y = 7,50 \text{ cm}^4$
 $W_y = 3,75 \text{ cm}^3$

PE (m)
 6 / 48 / 96 / 144

40x40 N-R

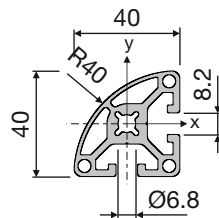

05.01943.00

M = 1,42 kg/m
 $I_x = 7,02 \text{ cm}^4$
 $W_x = 3,51 \text{ cm}^3$
 $I_y = 7,02 \text{ cm}^4$
 $W_y = 3,51 \text{ cm}^3$

PE (m)
 6 / 48 / 96 / 144

40x80 N

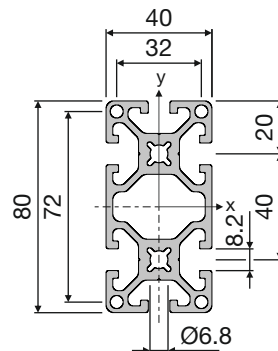
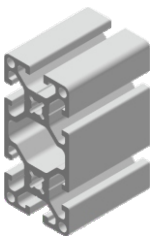

05.01003.00

M = 3,08 kg/m
 $I_x = 70,34 \text{ cm}^4$
 $W_x = 17,59 \text{ cm}^3$
 $I_y = 18,33 \text{ cm}^4$
 $W_y = 9,17 \text{ cm}^3$

PE (m)
 6 / 24 / 48 / 72

40x120 N

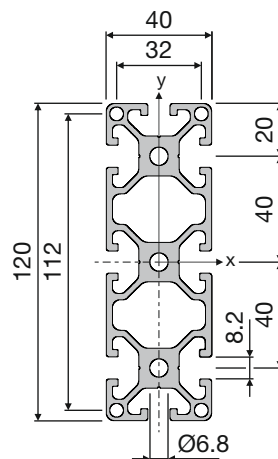
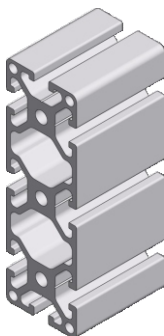

05.01047.00

M = 4,40 kg/m
 $I_x = 222,16 \text{ cm}^4$
 $W_x = 37,03 \text{ cm}^3$
 $I_y = 27,00 \text{ cm}^4$
 $W_y = 13,50 \text{ cm}^3$

PE (m)
 6 / 24 / 48 / 72

Technische Änderungen vorbehalten

ALU-PROFILE
PROFILES
PROFILES



40x160 N

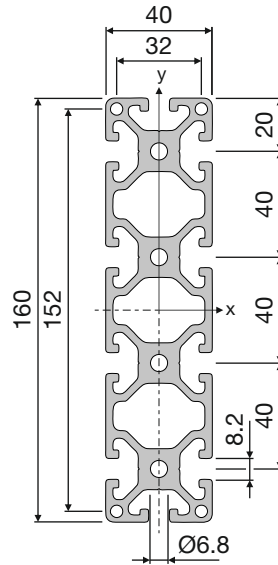
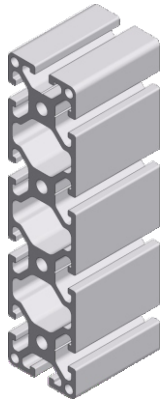

05.01820.00

M = 5,80 kg/m
 $I_x = 503,40 \text{ cm}^4$
 $W_x = 62,93 \text{ cm}^3$
 $I_y = 37,28 \text{ cm}^4$
 $W_y = 18,64 \text{ cm}^3$

PE (m)
 6 / 24 / 48 / 72

2

40x160 N-4N

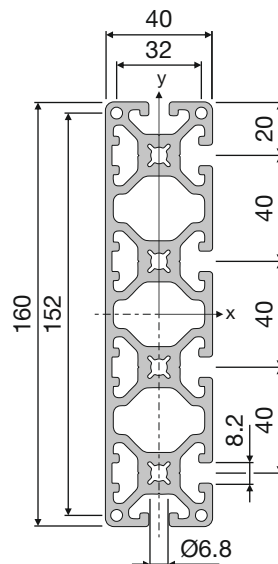
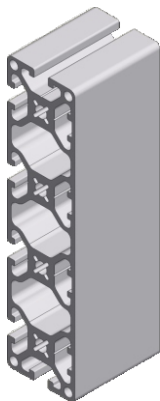

05.01819.00

M = 6,00 kg/m
 $I_x = 514,34 \text{ cm}^4$
 $W_x = 64,30 \text{ cm}^3$
 $I_y = 37,28 \text{ cm}^4$
 $W_y = 18,64 \text{ cm}^3$

PE (m)
 6 / 24 / 48 / 72

Technische Änderungen vorbehalten

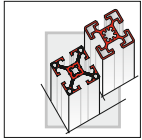

ALU-PROFILE
PROFILES
PROFILES



80x80 N

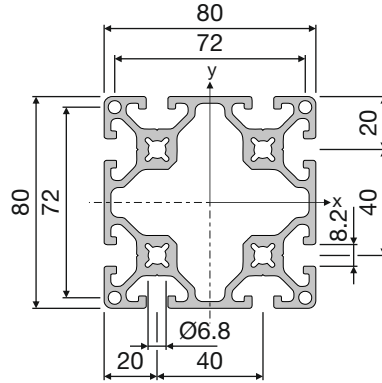
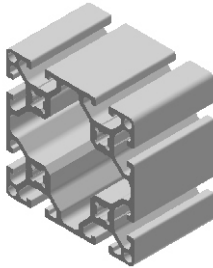

05.01004.00

M = 5,00 kg/m
 $I_x = 125,70 \text{ cm}^4$
 $W_x = 31,42 \text{ cm}^3$
 $I_y = 125,70 \text{ cm}^4$
 $W_y = 31,42 \text{ cm}^3$

PE (m)
 6 / 24 / 48 / 72

80x80 N-2N

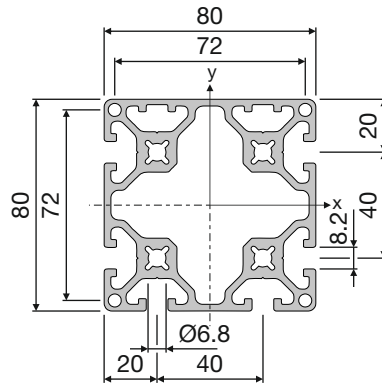
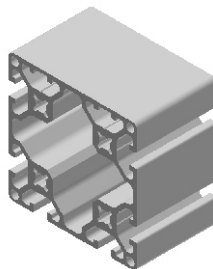

05.01931.00

M = 4,96 kg/m
 $I_x = 130,31 \text{ cm}^4$
 $W_x = 32,58 \text{ cm}^3$
 $I_y = 126,94 \text{ cm}^4$
 $W_y = 31,74 \text{ cm}^3$

PE (m)
 6 / 24 / 48 / 72

80x80 N-4N90

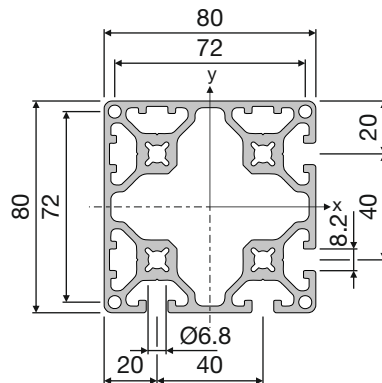
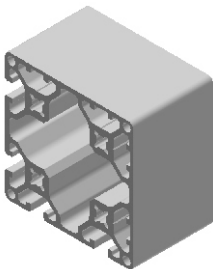

05.01932.00

M = 5,05 kg/m
 $I_x = 131,64 \text{ cm}^4$
 $W_x = 32,91 \text{ cm}^3$
 $I_y = 131,48 \text{ cm}^4$
 $W_y = 32,87 \text{ cm}^3$

PE (m)
 6 / 24 / 48 / 72

Technische Änderungen vorbehalten

ALU-PROFILE
PROFILES
PROFILES



80x120 N

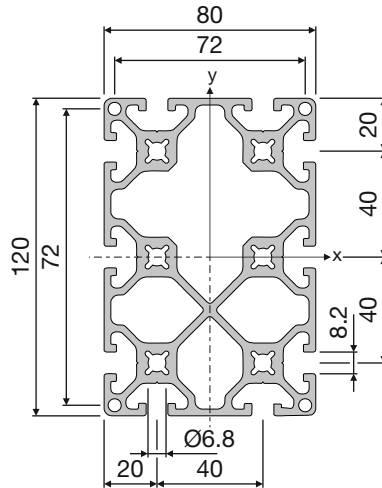
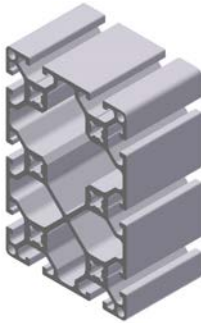

05.01823.00

- M = 7,16 kg/m
- $I_x = 384,71 \text{ cm}^4$
- $W_x = 64,14 \text{ cm}^3$
- $I_y = 182,71 \text{ cm}^4$
- $W_y = 45,68 \text{ cm}^3$

PE (m)
 6 / 12 / 24 / 36

80x160 N

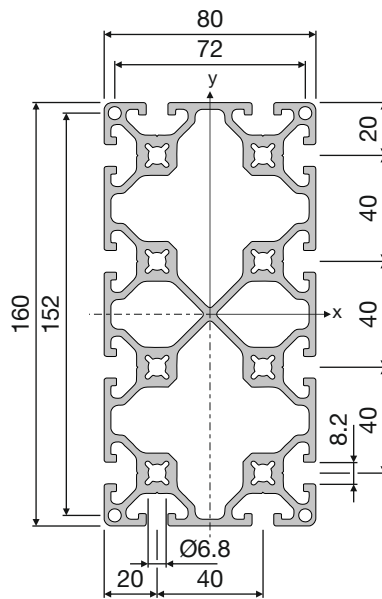
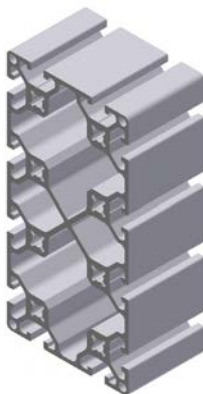

05.01824.00

- M = 8,86 kg/m
- $I_x = 820,19 \text{ cm}^4$
- $W_x = 102,52 \text{ cm}^3$
- $I_y = 238,14 \text{ cm}^4$
- $W_y = 59,54 \text{ cm}^3$

PE (m)
 6 / 12 / 24 / 36

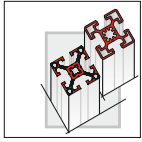

ALU-PROFILE
PROFILES
PROFILES



40R80 - 30°

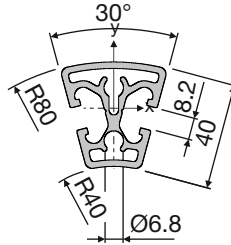
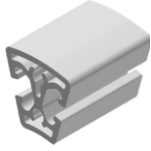

05.01866.00

M = 1,62 kg/m
I_x = 9,76 cm⁴
W_x = 4,80 cm³
I_y = 4,88 cm⁴
W_y = 3,07 cm³

PE (m)
6 / 48 / 96 / 144

40R80 - 45°

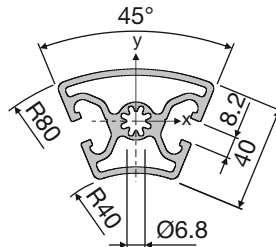

05.01867.00

M = 2,20 kg/m
I_x = 12,50 cm⁴
W_x = 5,63 cm³
I_y = 19,36 cm⁴
W_y = 6,53 cm³

PE (m)
6 / 36 / 72 / 108

40R80 - 60°

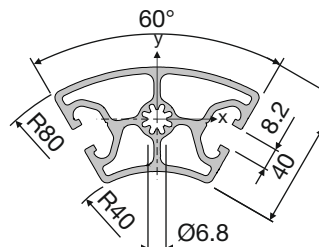
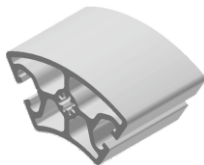

05.01868.00

M = 2,78 kg/m
I_x = 16,45 cm⁴
W_x = 6,76 cm³
I_y = 41,28 cm⁴
W_y = 10,62 cm³

PE (m)
6 / 24 / 48 / 72

40R80 - 90°

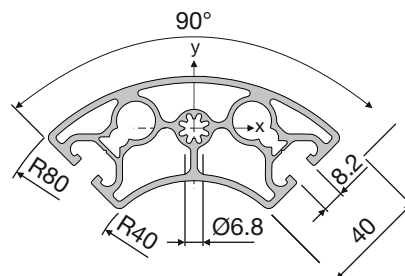
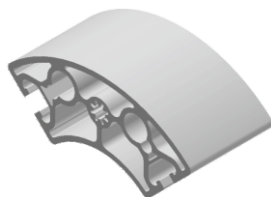

05.01869.00

M = 3,92 kg/m
I_x = 25,70 cm⁴
W_x = 9,51 cm³
I_y = 123,94 cm⁴
W_y = 22,42 cm³

PE (m)
6 / 18 / 36 / 54

Technische Änderungen vorbehalten

ALU-PROFILE PROFILES PROFILES



40x40 KL

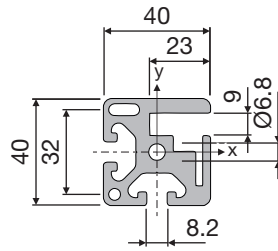

05.01940.00

M = 2,10 kg/m
 $I_x = 11,98 \text{ cm}^4$
 $W_x = 5,99 \text{ cm}^3$
 $I_y = 10,75 \text{ cm}^4$
 $W_y = 5,38 \text{ cm}^3$

PE (m)
 6 / 48 / 96 / 144

Klemmleiste und Schrauben nicht im Lieferumfang enthalten
 Clamping strips and screws are not included
 Baguette et vis ne sont pas inclus

40x40 KL-180°

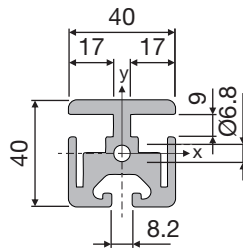

05.01942.00

M = 2,26 kg/m
 $I_x = 13,05 \text{ cm}^4$
 $W_x = 6,53 \text{ cm}^3$
 $I_y = 11,51 \text{ cm}^4$
 $W_y = 5,76 \text{ cm}^3$

PE (m)
 6 / 48 / 96 / 144

Klemmleiste und Schrauben nicht im Lieferumfang enthalten
 Clamping strips and screws are not included
 Baguette et vis ne sont pas inclus

Klemmleiste

Clamping strips · Baguette

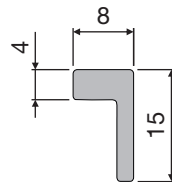
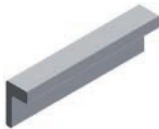

05.01922.00

PE (m)
 6



99.00005.00

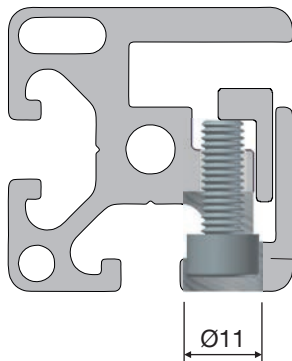

M6x16, DIN 7984
 Bitte separat bestellen
 Please order separately
 Commander séparément

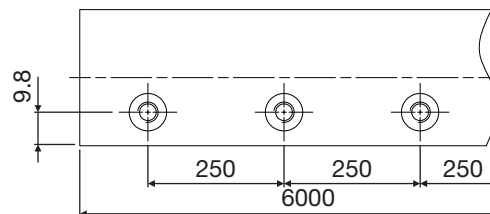

Bohrungen bereits im Profil vorhanden
 Holes already provided in profiles
 Profils déjà usinés

Technische Änderungen vorbehalten

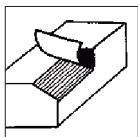

PROFILBEARBEITUNG

PROFILE FINISHING

USINAGE DE PROFILES

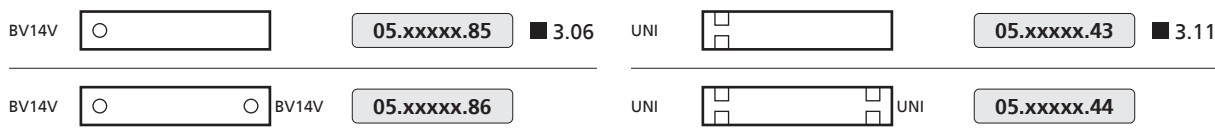
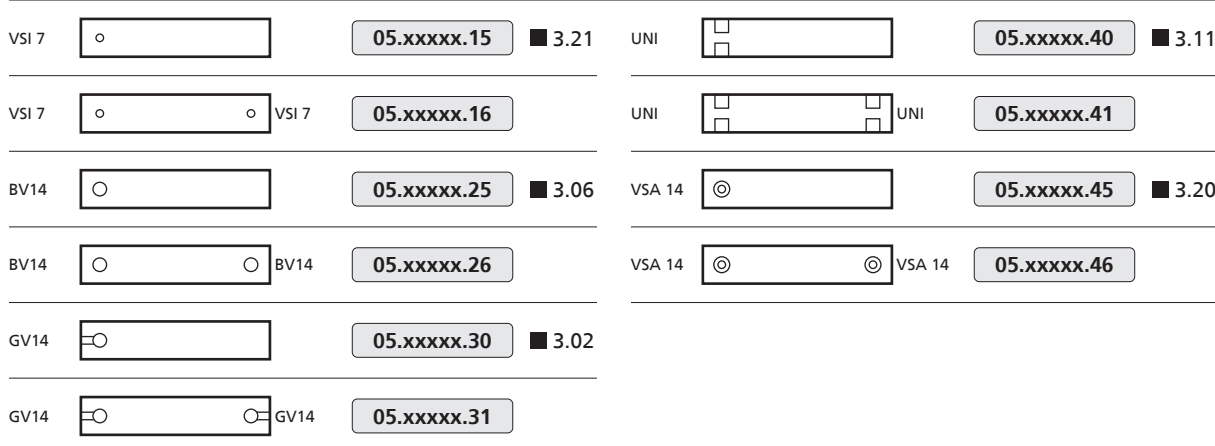
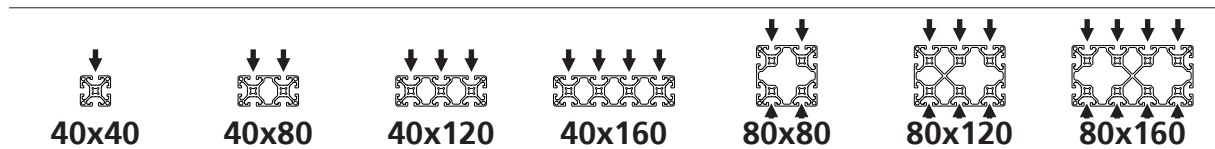
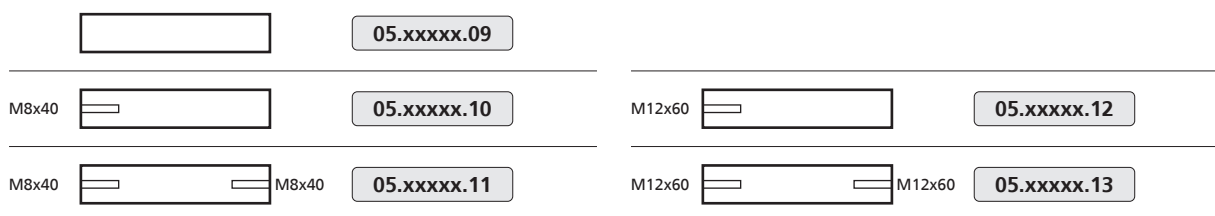
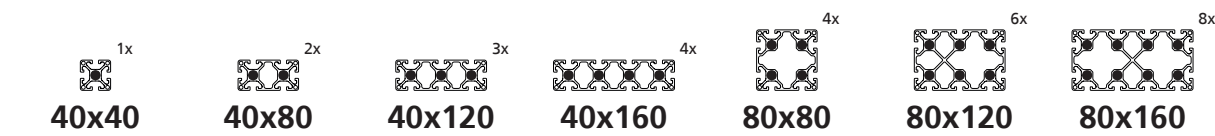

Technische Änderungen vorbehalten

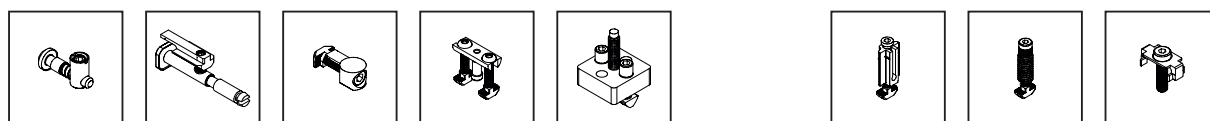

ALU-PROFILE
PROFILES
PROFILES



Konkavität

40x40 N-10K

40x80 N-10K

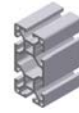
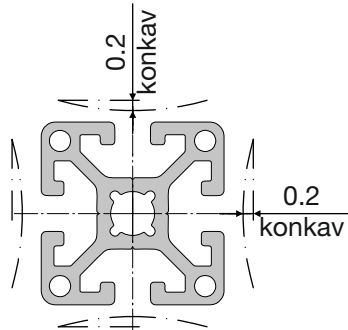

■ 2.41

■ 2.41

Nut 

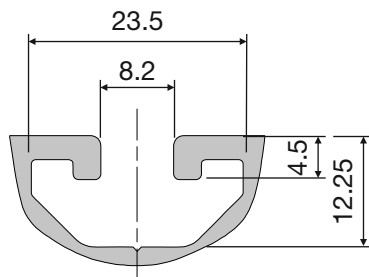

Kernloch

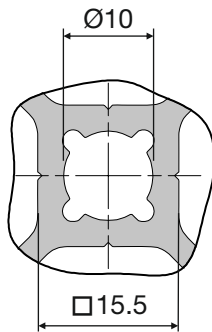

Außenkante

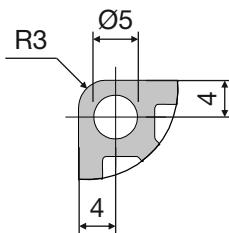

2

Technische Änderungen vorbehalten

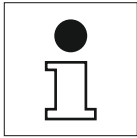

Durchbiegung der Profile
Profile deflection
Flexion des profilés

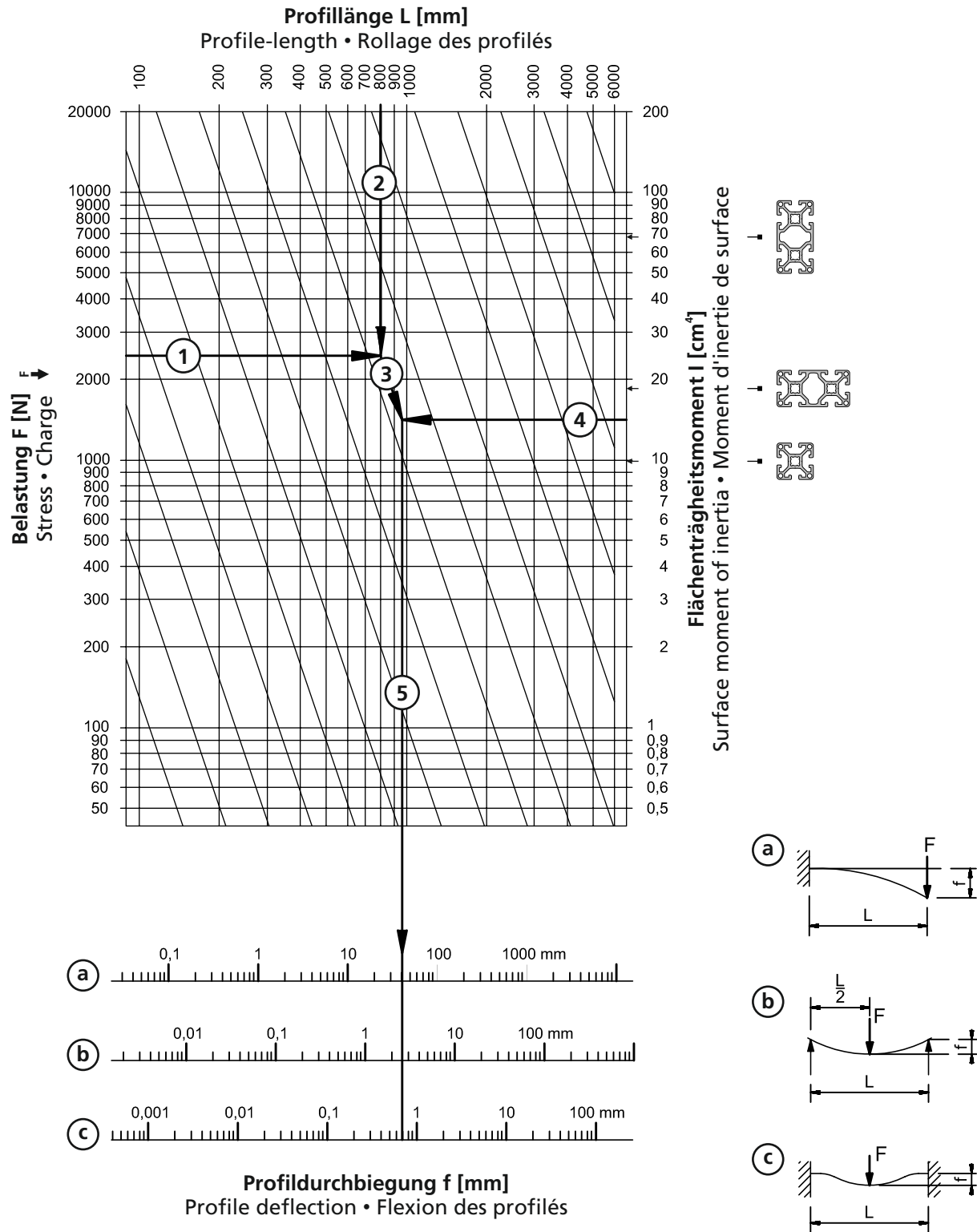

Technische Änderungen vorbehalten

ALU-PROFILE
PROFILES
PROFILES



40x40 N-10K

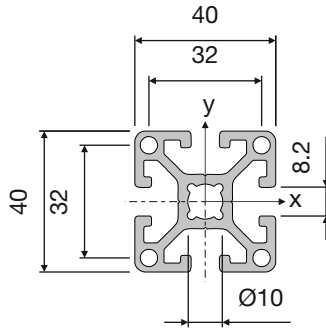
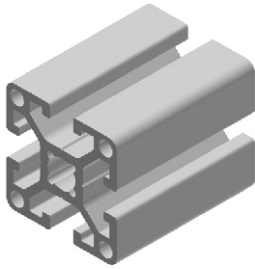

05.01133.00

M = 1,60 kg/m
 $I_x = 9,46 \text{ cm}^4$
 $W_x = 4,73 \text{ cm}^3$
 $I_y = 9,46 \text{ cm}^4$
 $W_y = 4,73 \text{ cm}^3$

PE (m)
 6 / 48 / 96 / 144

2

40x80 N-10K

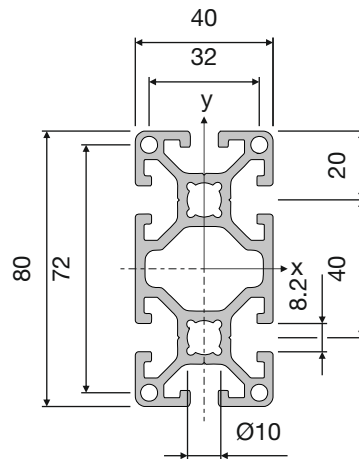
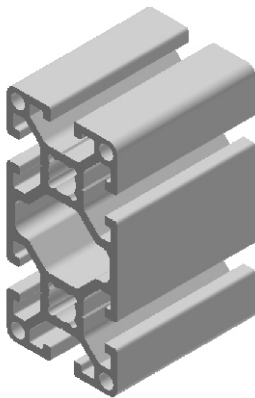

05.01134.00

M = 3,00 kg/m
 $I_x = 66,48 \text{ cm}^4$
 $W_x = 16,99 \text{ cm}^3$
 $I_y = 18,41 \text{ cm}^4$
 $W_y = 9,49 \text{ cm}^3$

PE (m)
 6 / 24 / 48 / 72

Technische Änderungen vorbehalten

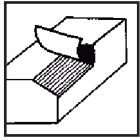

PROFILBEARBEITUNG

PROFILE FINISHING

USINAGE DE PROFILES



1x 2x

40x40-10K 40x80-10K

		05.xxxxx.09
M12x60		05.xxxxx.12
M12x60		05.xxxxx.13

40x40-10K 40x80-10K

VSI 7		05.xxxxx.15	■ 3.21	UNI		05.xxxxx.40	■ 3.11
VSI 7		05.xxxxx.16		UNI		05.xxxxx.41	
BV14		05.xxxxx.25	■ 3.06	VSA 14		05.xxxxx.45	■ 3.20
BV14		05.xxxxx.26		VSA 14		05.xxxxx.46	
GV14		05.xxxxx.30	■ 3.02				
GV14		05.xxxxx.31					
AGV		05.xxxxx.35	■ 3.04				
AGV		05.xxxxx.36					

40x80

BV14V		05.xxxxx.85	■ 3.06	UNI		05.xxxxx.43	■ 3.11
BV14V		05.xxxxx.86		UNI		05.xxxxx.44	
AGV		05.xxxxx.83	■ 3.04				
AGV		05.xxxxx.84					

Technische Änderungen vorbehalten

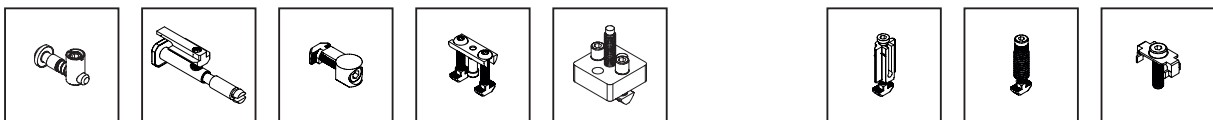

ALU-PROFILE
PROFILES
PROFILES



Konkavität

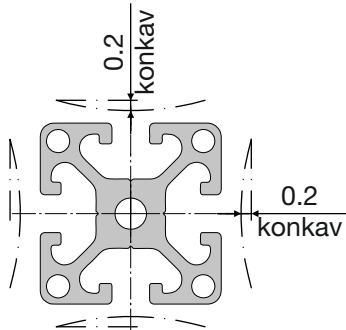

40x40MS	40x80MS	80x80MS
■ 2.45	■ 2.45	■ 2.45

2

Nut

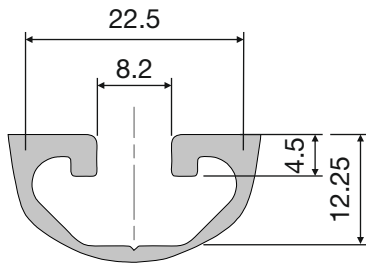

Kernloch

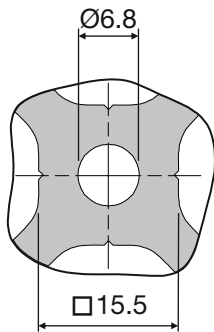

Außenkante

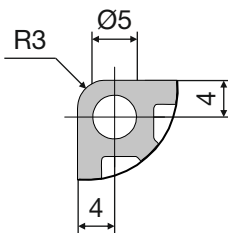

Technische Änderungen vorbehalten

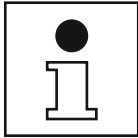

Durchbiegung der Profile
Profile deflection
Flexion des profilés

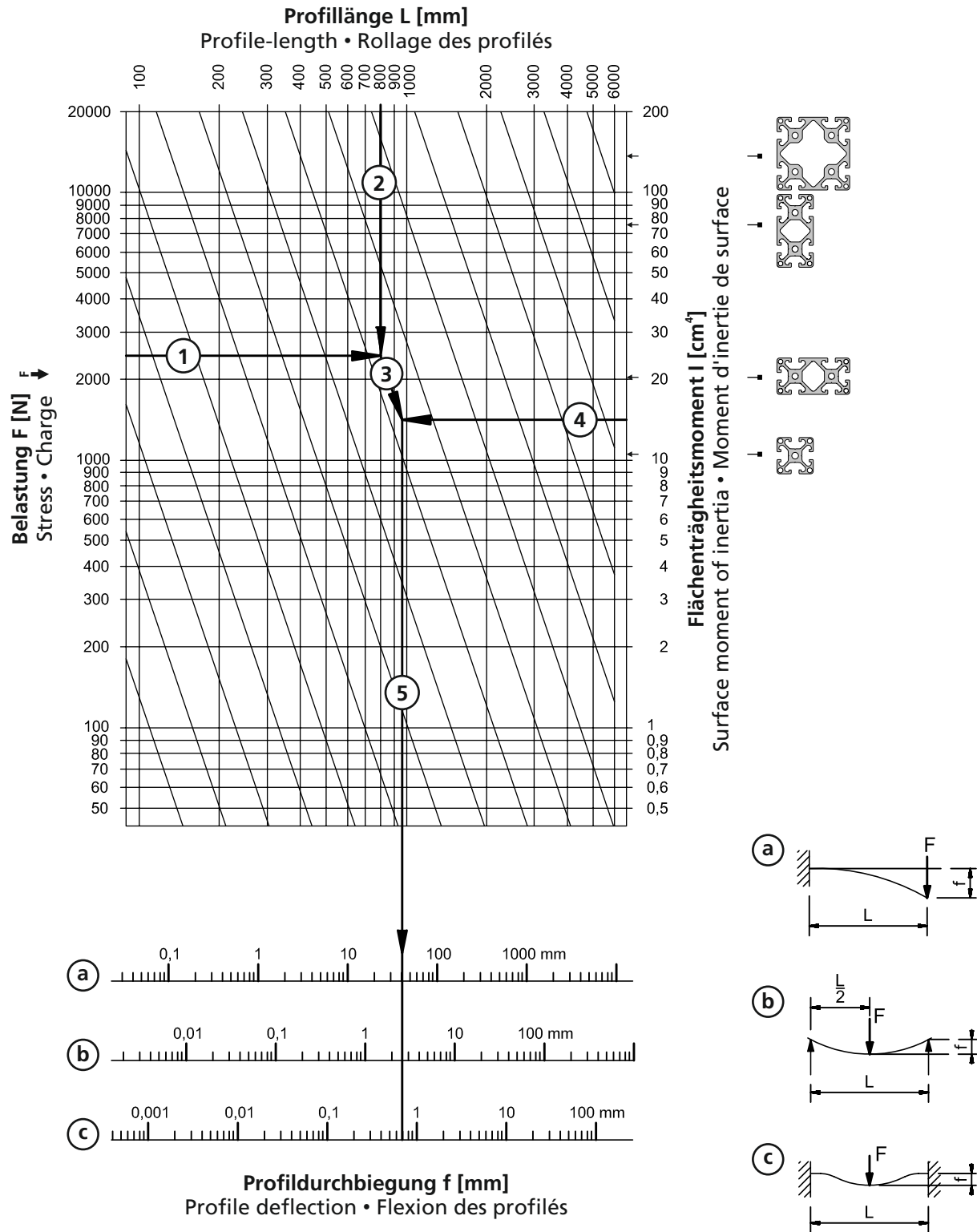

Technische Änderungen vorbehalten

ALU-PROFILE
PROFILES
PROFILES



40x40 MS

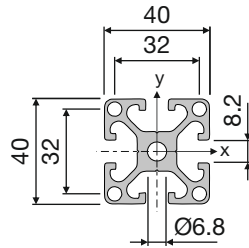
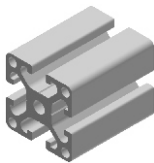

05.01114.00

M = 1,90 kg/m
 $I_x = 10,52 \text{ cm}^4$
 $W_x = 5,26 \text{ cm}^3$
 $I_y = 10,52 \text{ cm}^4$
 $W_y = 5,26 \text{ cm}^3$

PE (m)
 6 / 48 / 96 / 144



40x80 MS

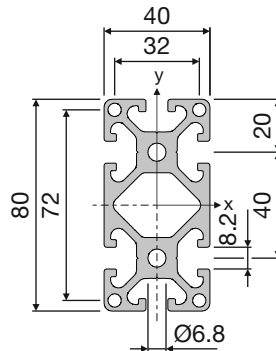
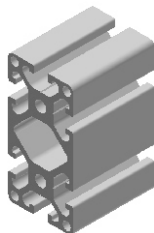

05.01115.00

M = 3,55 kg/m
 $I_x = 77,43 \text{ cm}^4$
 $W_x = 18,98 \text{ cm}^3$
 $I_y = 21,34 \text{ cm}^4$
 $W_y = 10,67 \text{ cm}^3$

PE (m)
 6 / 24 / 48 / 72

80x80 MS

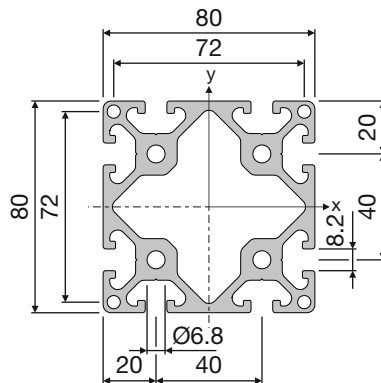
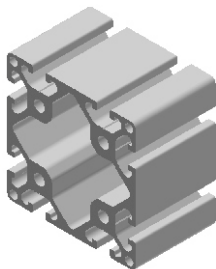

05.01116.00

M = 5,66 kg/m
 $I_x = 144,01 \text{ cm}^4$
 $W_x = 36,00 \text{ cm}^3$
 $I_y = 144,01 \text{ cm}^4$
 $W_y = 36,00 \text{ cm}^3$

PE (m)
 6 / 24 / 48 / 72

Technische Änderungen vorbehalten

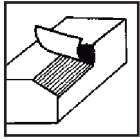

PROFILBEARBEITUNG

PROFILE FINISHING

USINAGE DE PROFILES



		05.xxxxx.09			
M8x40		05.xxxxx.10		M12x60	05.xxxxx.12
M8x40		05.xxxxx.11		M12x60	05.xxxxx.13

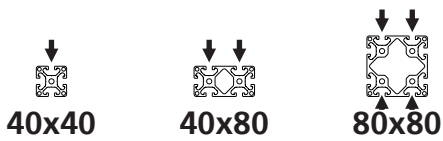

VSI 7		05.xxxxx.15	■ 3.21	UNI		05.xxxxx.40	■ 3.11
VSI 7		05.xxxxx.16		UNI		05.xxxxx.41	
BV14		05.xxxxx.25	■ 3.06	VSA 14		05.xxxxx.45	■ 3.20
BV14		05.xxxxx.26		VSA 14		05.xxxxx.46	
GV14		05.xxxxx.30	■ 3.02				
GV14		05.xxxxx.31					
AGV		05.xxxxx.35	■ 3.04				
AGV		05.xxxxx.36					



BV14V		05.xxxxx.85	■ 3.06	UNI		05.xxxxx.43	■ 3.11
BV14V		05.xxxxx.86		UNI		05.xxxxx.44	
AGV		05.xxxxx.83	■ 3.04				
AGV		05.xxxxx.84					

Technische Änderungen vorbehalten

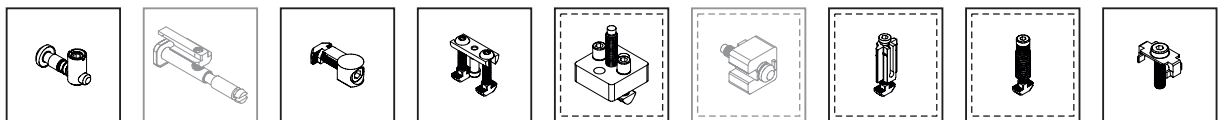

ALU-PROFILE PROFILES PROFILES



2

Konkavität

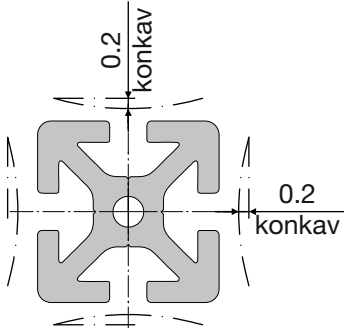

Nut 8S

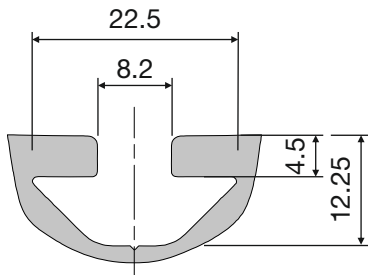

Kernloch

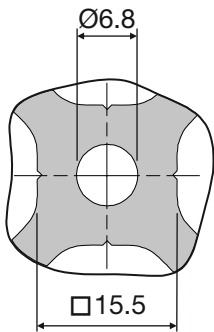

Außenkante

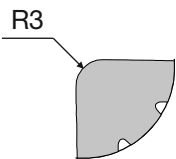

40x40S	40x80S	40x120S	40x160S
■ 2.49	■ 2.49	■ 2.49	■ 2.50
80x80S	80x120S	80x160S	
■ 2.50	■ 2.51	■ 2.51	
120x120S	120x160S		
■ 2.52	■ 2.52		

Technische Änderungen vorbehalten

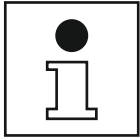

Durchbiegung der Profile
Profile deflection
Flexion des profilés

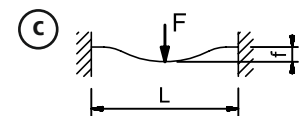
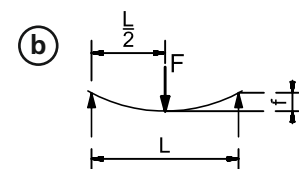
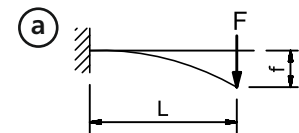
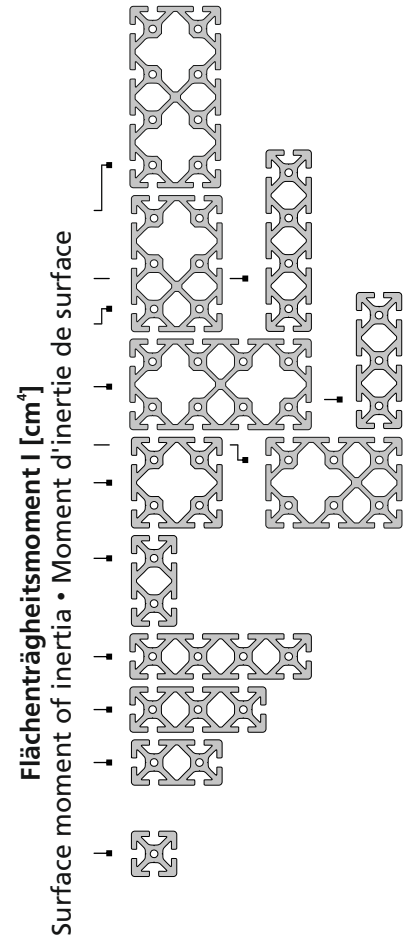
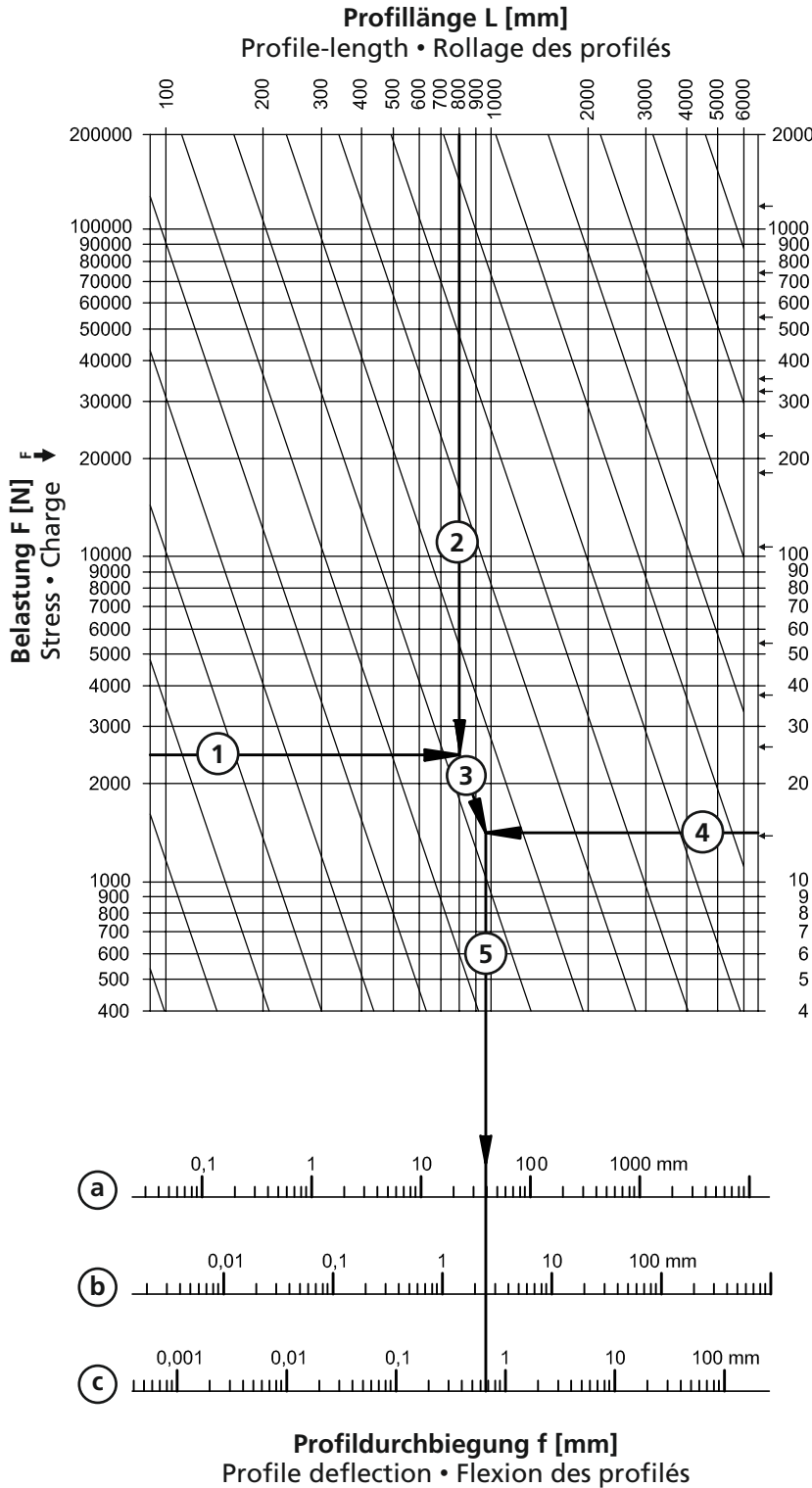

40x40 S

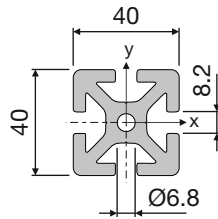
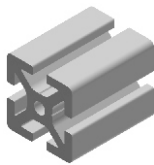

05.01005.00

M = 2,45 kg/m
 $I_x = 13,90 \text{ cm}^4$
 $W_x = 6,95 \text{ cm}^3$
 $I_y = 13,90 \text{ cm}^4$
 $W_y = 6,95 \text{ cm}^3$

PE (m)
 6 / 48 / 96 / 144

40x80 S

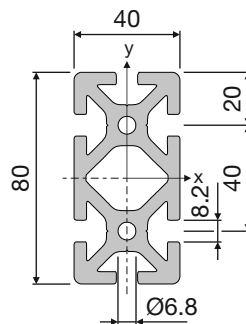
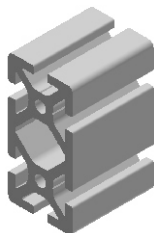

05.01006.00

M = 4,38 kg/m
 $I_x = 99,52 \text{ cm}^4$
 $W_x = 24,88 \text{ cm}^3$
 $I_y = 26,31 \text{ cm}^4$
 $W_y = 13,16 \text{ cm}^3$

PE (m)
 6 / 24 / 48 / 72

40x120 S

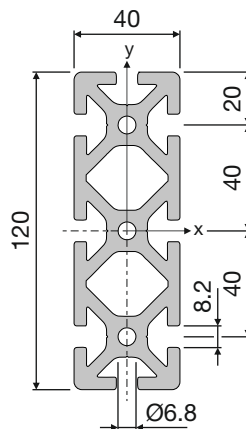
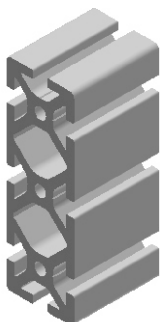

05.01008.00

M = 6,33 kg/m
 $I_x = 314,79 \text{ cm}^4$
 $W_x = 153,17 \text{ cm}^3$
 $I_y = 38,73 \text{ cm}^4$
 $W_y = 19,80 \text{ cm}^3$

PE (m)
 6 / 24 / 48 / 72

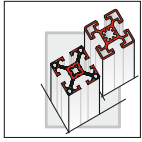

ALU-PROFILE
PROFILES
PROFILES



40x160 S

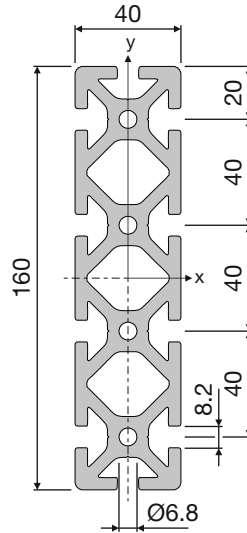
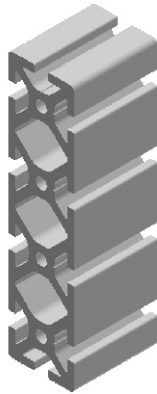

05.01814.00

M = 8,28 kg/m
I_x = 717,64 cm⁴
W_x = 89,71 cm³
I_y = 51,14 cm⁴
W_y = 25,14 cm³

PE (m)
6 / 24 / 48 / 72

80x80 S

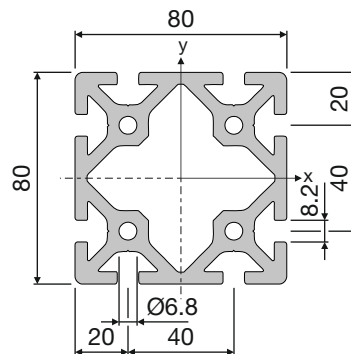
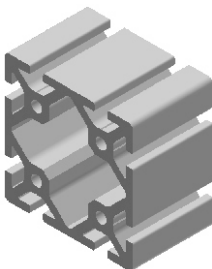

05.01007.00

M = 6,88 kg/m
I_x = 179,43 cm⁴
W_x = 44,86 cm³
I_y = 179,43 cm⁴
W_y = 44,86 cm³

PE (m)
6 / 24 / 48 / 72

ALU-PROFILE
PROFILES
PROFILES



80x120 S

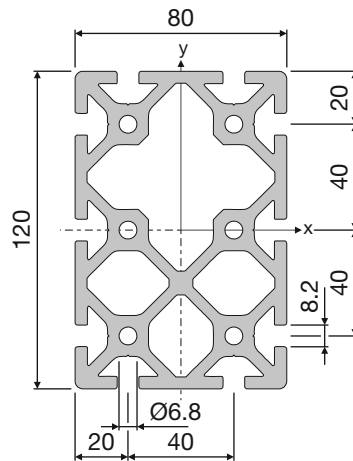
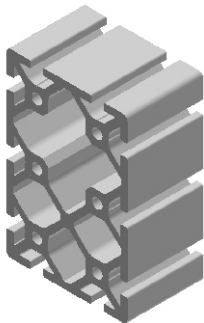

05.01817.00

M = 9,85 kg/m
 $I_x = 537,80 \text{ cm}^4$
 $W_x = 89,63 \text{ cm}^3$
 $I_y = 255,13 \text{ cm}^4$
 $W_y = 63,78 \text{ cm}^3$

PE (m)
 6 / 12 / 24 / 36

80x160 S

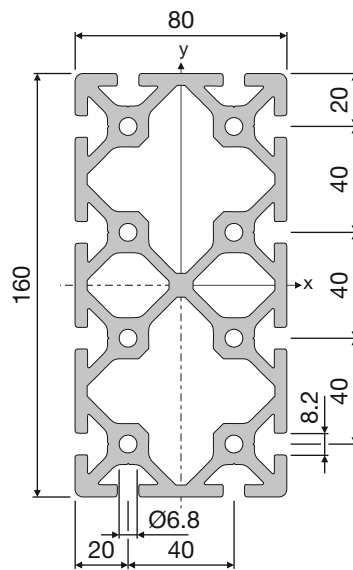
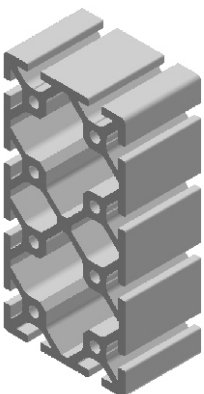

05.01818.00

M = 12,18 kg/m
 $I_x = 1139,68 \text{ cm}^4$
 $W_x = 142,46 \text{ cm}^3$
 $I_y = 331,86 \text{ cm}^4$
 $W_y = 82,97 \text{ cm}^3$

PE (m)
 6 / 12 / 24 / 36

Technische Änderungen vorbehalten

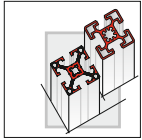

ALU-PROFILE
PROFILES
PROFILES



120x120 S

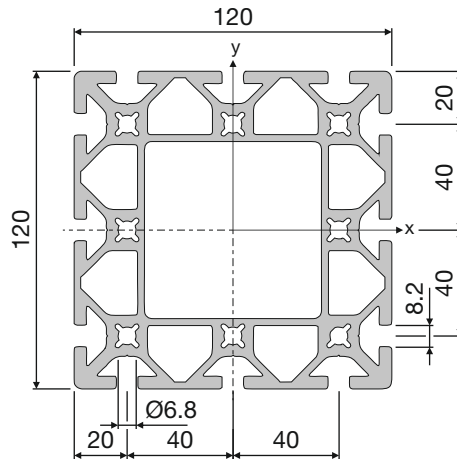
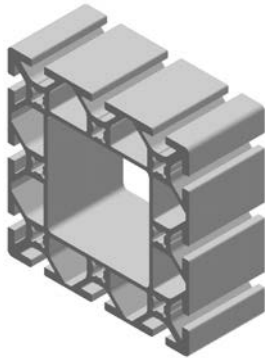

05.01709.00

M = 11,13 kg/m
 $I_x = 691,97 \text{ cm}^4$
 $W_x = 115,33 \text{ cm}^3$
 $I_y = 691,97 \text{ cm}^4$
 $W_y = 115,33 \text{ cm}^3$

PE (m)
 6 / 12 / 24 / 36

120x160 S

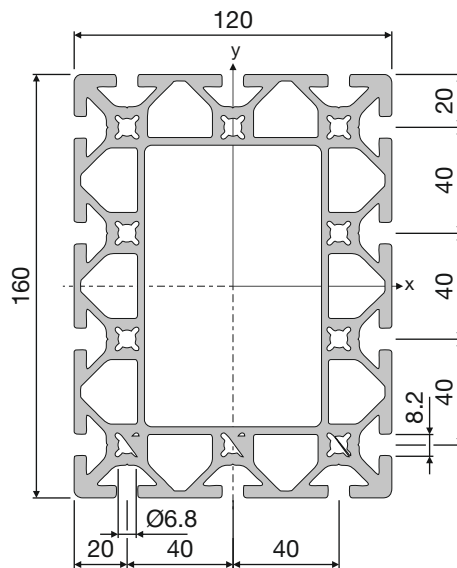
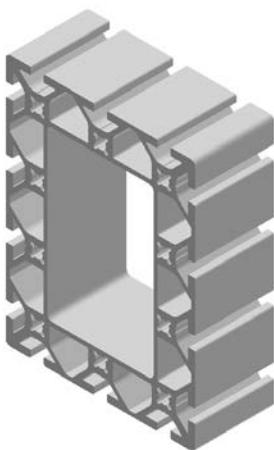

05.01710.00

M = 13,48 kg/m
 $I_x = 1490,66 \text{ cm}^4$
 $W_x = 186,33 \text{ cm}^3$
 $I_y = 883,09 \text{ cm}^4$
 $W_y = 147,18 \text{ cm}^3$

PE (m)
 6 / 12 / 24 / 36

Technische Änderungen vorbehalten

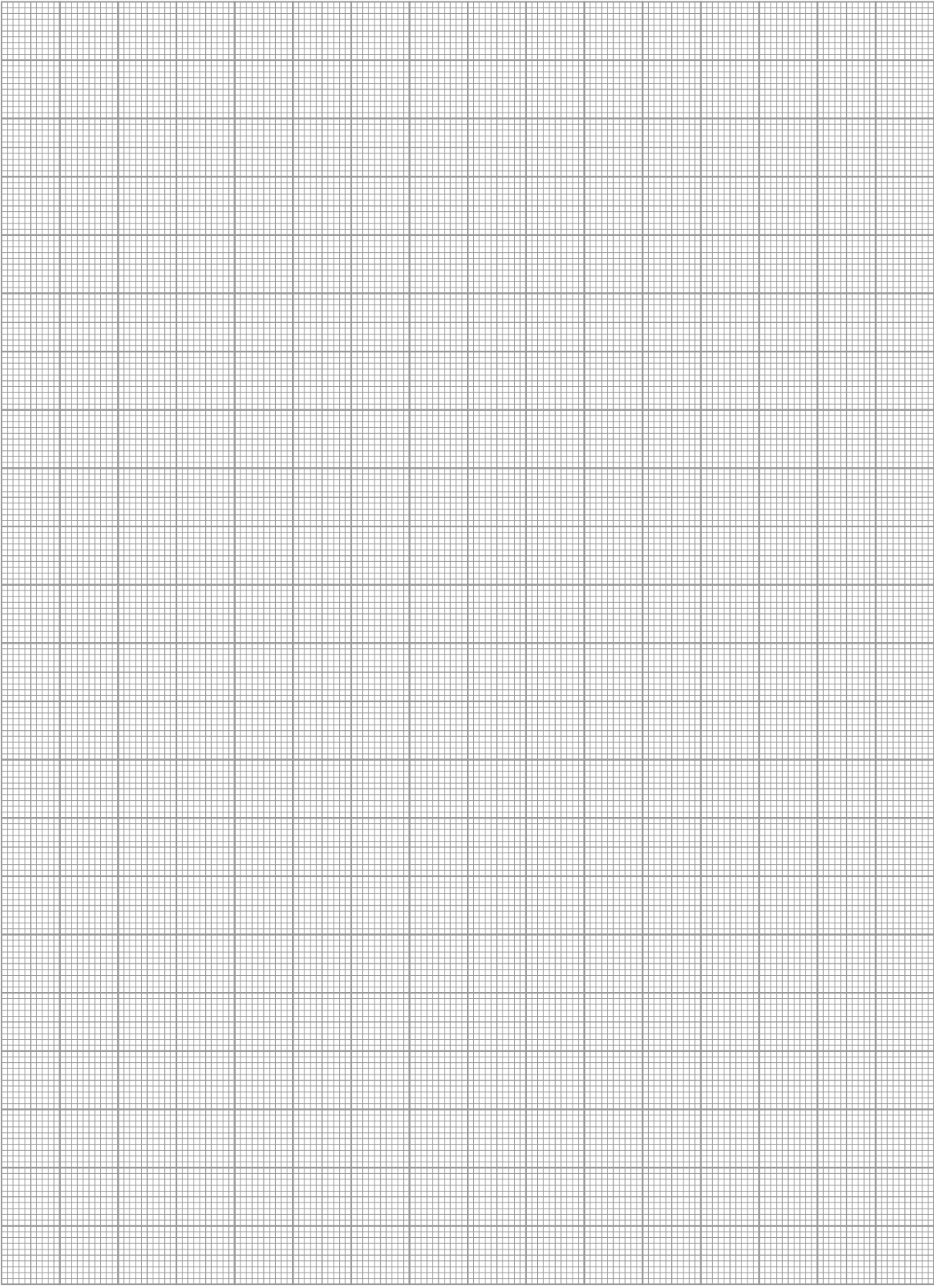

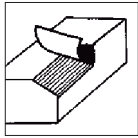

PROFILBEARBEITUNG

PROFILE FINISHING

USINAGE DE PROFILES

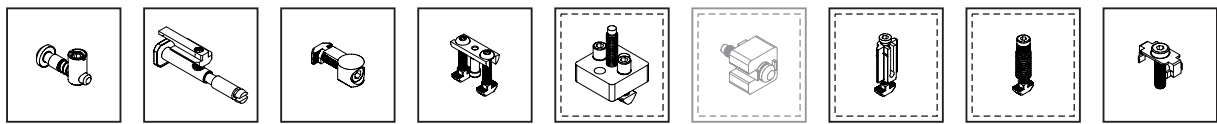
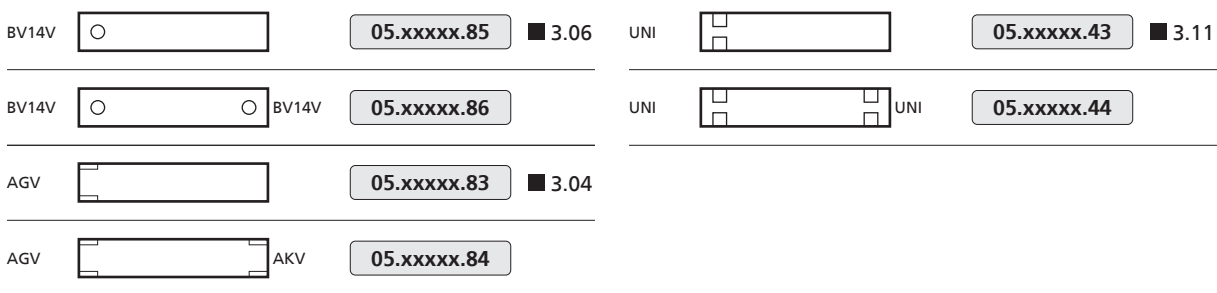
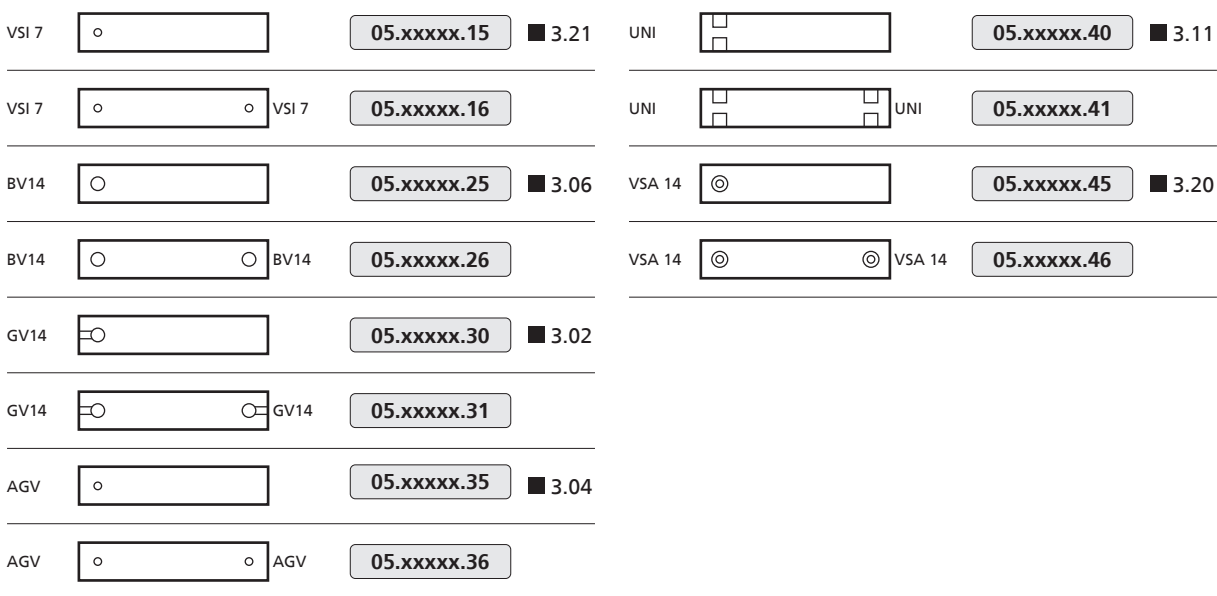
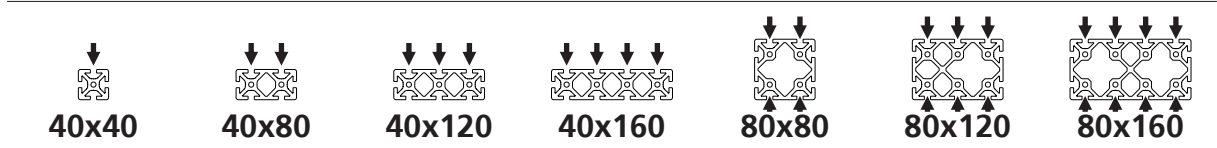
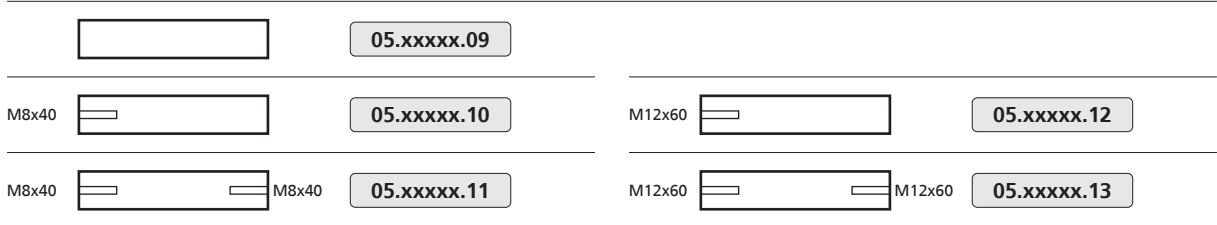
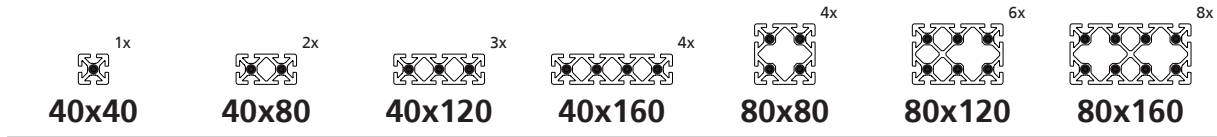

Technische Änderungen vorbehalten

Konkavität

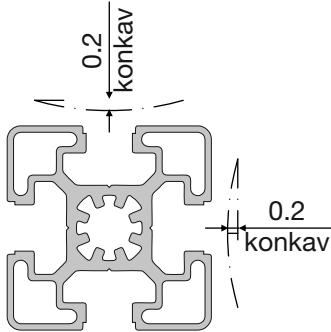

Nut

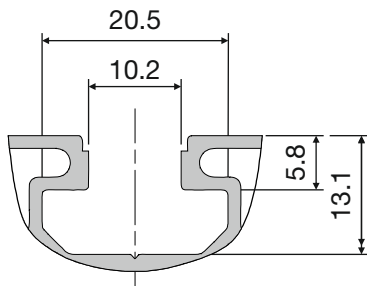

Kernloch

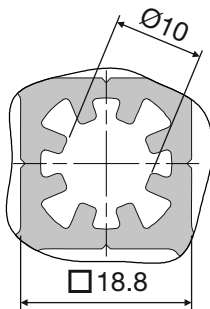

Außenkante

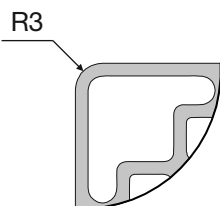

45x45EL-1.4



■ 2.57

45x45L-2N180



■ 2.57

45x90EL-2.9



■ 2.58

45x45L-1.6



■ 2.57

45x45L-3N



■ 2.57

60x60L

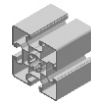

■ 2.59

45x45L-1N



■ 2.57

45x45L-R



■ 2.58

45x180L

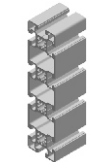

■ 2.59

45x45L-2N90



■ 2.57

45x60L



■ 2.58

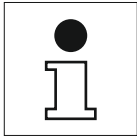

Durchbiegung der Profile
Profile deflection
Flexion des profilés

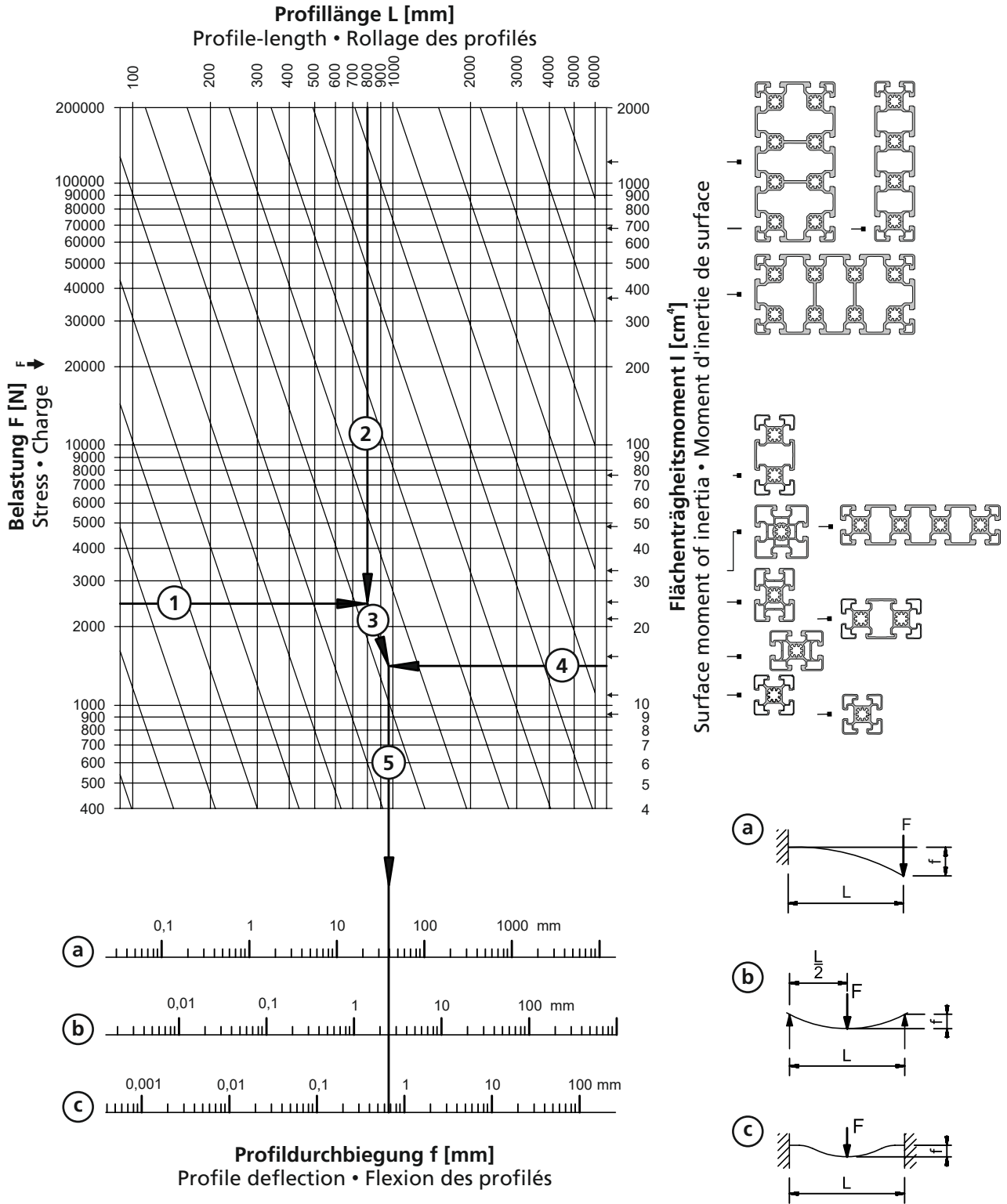

ALU-PROFILE PROFILES PROFILES



45x45 EL-1.4

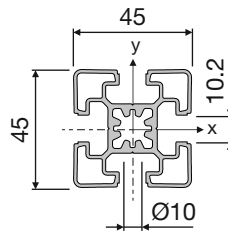
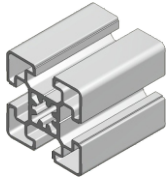

05.01517.00

M = 1,40 kg/m
 $I_x = 9,28 \text{ cm}^4$
 $W_x = 4,12 \text{ cm}^3$
 $I_y = 9,28 \text{ cm}^4$
 $W_y = 4,12 \text{ cm}^3$

PE (m)
 6 / 48 / 96 / 144

45x45 L-1.6

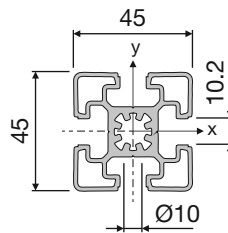
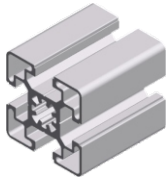

05.01041.00

M = 1,60 kg/m
 $I_x = 10,17 \text{ cm}^4$
 $W_x = 4,52 \text{ cm}^3$
 $I_y = 10,17 \text{ cm}^4$
 $W_y = 4,52 \text{ cm}^3$

PE (m)
 6 / 48 / 96 / 144

45x45 L-1N

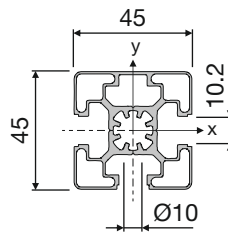
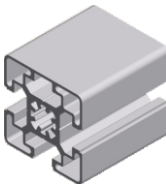

05.01900.00

M = 1,65 kg/m
 $I_x = 10,95 \text{ cm}^4$
 $W_x = 4,87 \text{ cm}^3$
 $I_y = 10,19 \text{ cm}^4$
 $W_y = 4,53 \text{ cm}^3$

PE (m)
 6 / 48 / 96 / 144

45x45 L-2N90

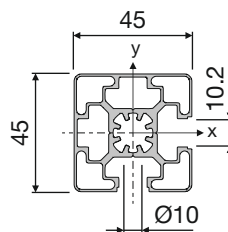
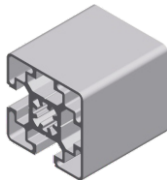

05.01901.00

M = 1,69 kg/m
 $I_x = 10,97 \text{ cm}^4$
 $W_x = 4,88 \text{ cm}^3$
 $I_y = 10,97 \text{ cm}^4$
 $W_y = 4,88 \text{ cm}^3$

PE (m)
 6 / 48 / 96 / 144

45x45 L-2N180

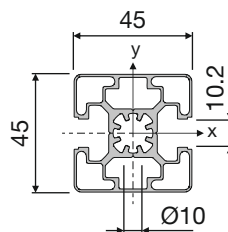
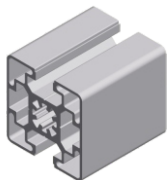

05.01902.00

M = 1,69 kg/m
 $I_x = 11,73 \text{ cm}^4$
 $W_x = 4,88 \text{ cm}^3$
 $I_y = 10,21 \text{ cm}^4$
 $W_y = 4,88 \text{ cm}^3$

PE (m)
 6 / 48 / 96 / 144

45x45 L-3N

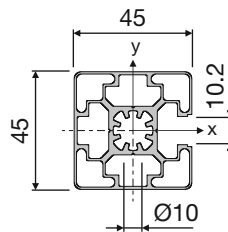
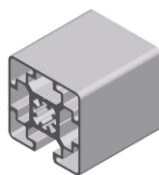

05.01903.00

M = 1,74 kg/m
 $I_x = 11,75 \text{ cm}^4$
 $W_x = 4,88 \text{ cm}^3$
 $I_y = 10,97 \text{ cm}^4$
 $W_y = 4,88 \text{ cm}^3$

PE (m)
 6 / 48 / 96 / 144

2

Technische Änderungen vorbehalten

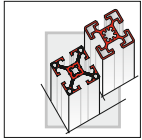

ALU-PROFILE
PROFILES
PROFILES



45x45 L-R

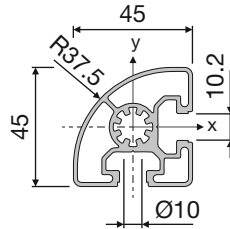
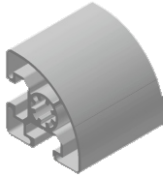

05.01904.00

M = 1,32 kg/m
 $I_x = 8,19 \text{ cm}^4$
 $W_x = 3,64 \text{ cm}^3$
 $I_y = 8,19 \text{ cm}^4$
 $W_y = 3,64 \text{ cm}^3$

PE (m)
 6 / 48 / 96 / 144

45x60 L

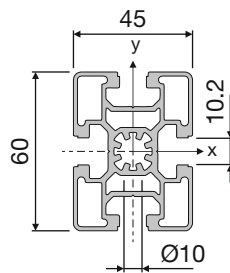
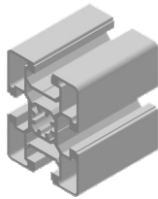

05.01043.00

M = 2,19 kg/m
 $I_x = 25,14 \text{ cm}^4$
 $W_x = 8,38 \text{ cm}^3$
 $I_y = 14,73 \text{ cm}^4$
 $W_y = 6,55 \text{ cm}^3$

PE (m)
 6 / 24 / 48 / 72

45x90 L-2.9

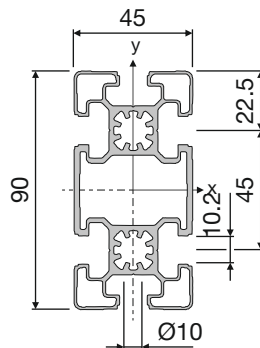
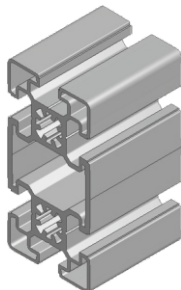

05.01518.00

M = 2,94 kg/m
 $I_x = 78,52 \text{ cm}^4$
 $W_x = 17,45 \text{ cm}^3$
 $I_y = 21,48 \text{ cm}^4$
 $W_y = 9,55 \text{ cm}^3$

PE (m)
 6 / 24 / 48 / 72

Technische Änderungen vorbehalten

ALU-PROFILE
PROFILES
PROFILES



60x60 L

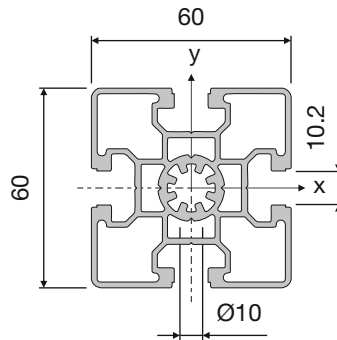
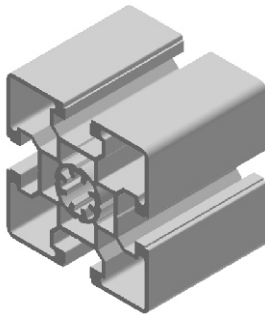

05.01012.00

M = 2,58 kg/m
 $I_x = 30,01 \text{ cm}^4$
 $W_x = 10,01 \text{ cm}^3$
 $I_y = 30,01 \text{ cm}^4$
 $W_y = 10,01 \text{ cm}^3$

PE (m)
 6 / 18 / 36 / 72

2

45x180 L

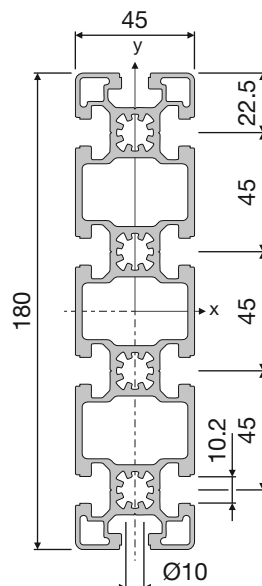
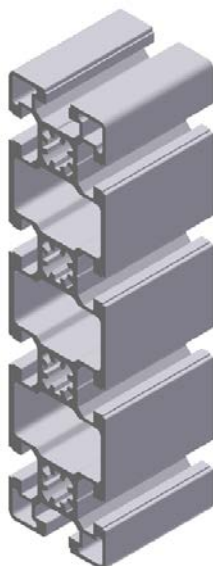

05.01044.00

M = 6,24 kg/m
 $I_x = 686,62 \text{ cm}^4$
 $W_x = 76,14 \text{ cm}^3$
 $I_y = 49,57 \text{ cm}^4$
 $W_y = 22,01 \text{ cm}^3$

PE (m)
 6 / 12 / 24 / 36

Technische Änderungen vorbehalten

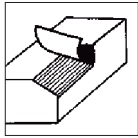

PROFILBEARBEITUNG

PROFILE FINISHING

USINAGE DE PROFILES



1x 45x45	1x 45x60	2x 45x90	4x 45x180	1x 60x60	4x 90x90	8x 90x180
--------------------	--------------------	--------------------	---------------------	--------------------	--------------------	---------------------

	05.xxxxx.09		05.xxxxx.10		05.xxxxx.12
M12x60	05.xxxxx.11	M16x115	05.xxxxx.13	M12x60	M16x115

45x45	45x60	45x90	45x180	60x60	90x90	90x180
--------------	--------------	--------------	---------------	--------------	--------------	---------------

VSI 9.5	05.xxxxx.15 ■ 3.21	AGV	05.xxxxx.35 ■ 3.04
VSI 9.5	05.xxxxx.16	AGV	05.xxxxx.36
BV17	05.xxxxx.25 ■ 3.06	UNI	05.xxxxx.40 ■ 3.11
BV17	05.xxxxx.26	UNI	05.xxxxx.41
GV16	05.xxxxx.30 ■ 3.02	VSA 20	05.xxxxx.45 ■ 3.20
GV16	05.xxxxx.31	VSA 20	05.xxxxx.46

← 45x60	45x90 ←		
BV17V	05.xxxxx.85 ■ 3.06	UNI	05.xxxxx.43 ■ 3.11
BV17V	05.xxxxx.86	UNI	05.xxxxx.44

Technische Änderungen vorbehalten

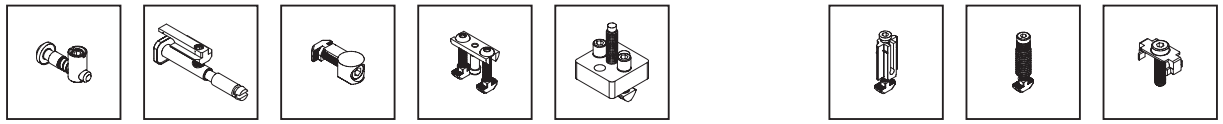

ALU-PROFILE
PROFILES
PROFILES



Konkavität

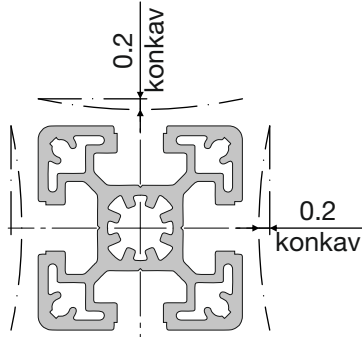

45x45N-1.9

45x60N-2.85

45x90N-3.4

90x90N



■ 2.63



■ 2.63

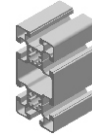

■ 2.63

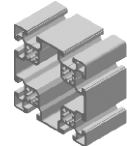

■ 2.63

2

Nut

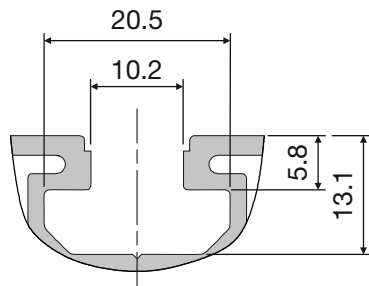

Kernloch

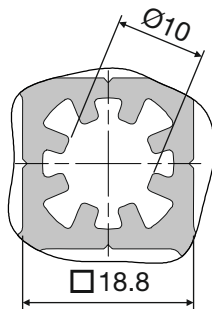

Außenkante

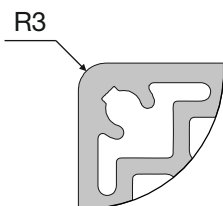

Technische Änderungen vorbehalten

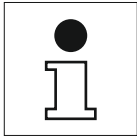

Durchbiegung der Profile
Profile deflection
Flexion des profilés

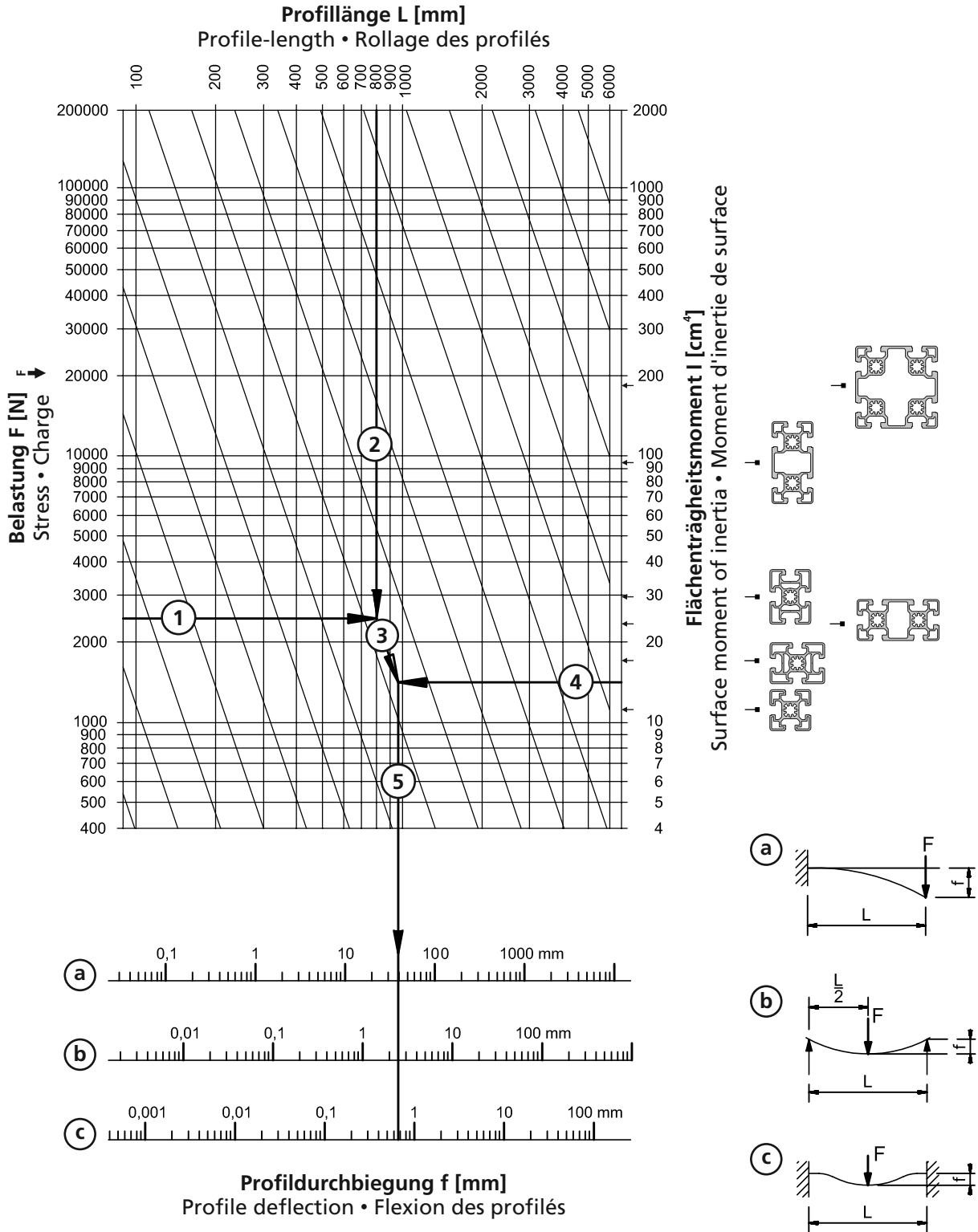

Technische Änderungen vorbehalten

ALU-PROFILE
PROFILES
PROFILES



45x45 N-1.9

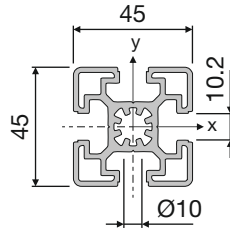
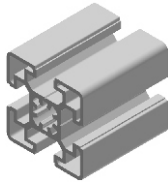

05.01498.00

M = 1,88 kg/m
 $I_x = 12,95 \text{ cm}^4$
 $W_x = 5,76 \text{ cm}^3$
 $I_y = 12,95 \text{ cm}^4$
 $W_y = 5,76 \text{ cm}^3$

PE (m)
 6 / 48 / 96 / 144

45x60 N-2.85

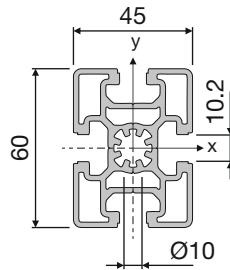
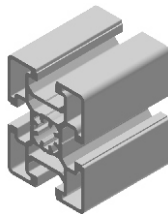

05.01499.00

M = 2,85 kg/m
 $I_x = 29,72 \text{ cm}^4$
 $W_x = 9,91 \text{ cm}^3$
 $I_y = 17,63 \text{ cm}^4$
 $W_y = 7,84 \text{ cm}^3$

PE (m)
 6 / 24 / 48 / 72

45x90 N-3.4

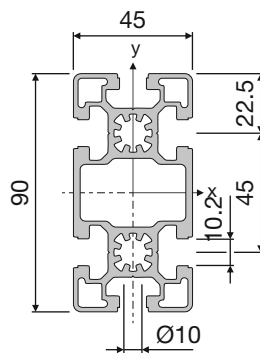
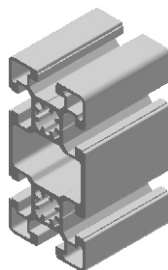

05.01013.00

M = 3,40 kg/m
 $I_x = 94,84 \text{ cm}^4$
 $W_x = 21,08 \text{ cm}^3$
 $I_y = 24,90 \text{ cm}^4$
 $W_y = 11,07 \text{ cm}^3$

PE (m)
 6 / 24 / 48 / 72

90x90 N

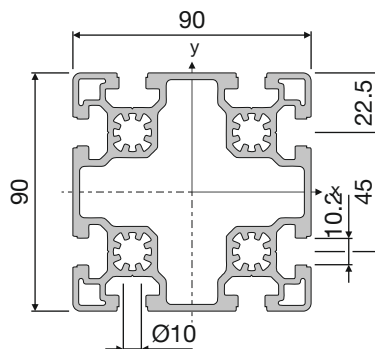
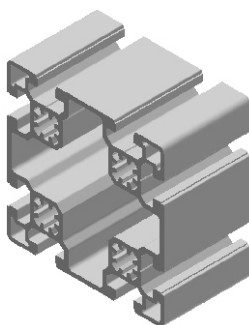

05.01014.00

M = 5,68 kg/m
 $I_x = 190,13 \text{ cm}^4$
 $W_x = 38,28 \text{ cm}^3$
 $I_y = 190,13 \text{ cm}^4$
 $W_y = 38,28 \text{ cm}^3$

PE (m)
 6 / 24 / 48 / 72

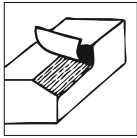













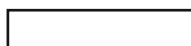



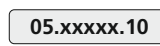

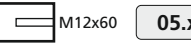

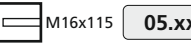





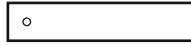

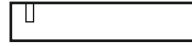



PROFILBEARBEITUNG

PROFILE FINISHING

USINAGE DE PROFILES

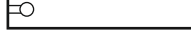

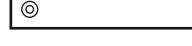
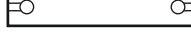
 1x	 1x	 2x	 4x
45x45	45x60	45x90	90x90
			
		05.xxxxx.09	
M12x60 		05.xxxxx.10	M16x115 
M12x60   M12x60		05.xxxxx.11	M16x115   M16x115

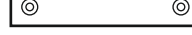
			
45x45	45x60	45x90	90x90
VSI 9.5 		05.xxxxx.15 ■ 3.21	AGV 
VSI 9.5 	VSI 9.5 	05.xxxxx.16	AGV  AGV
BV17 		05.xxxxx.25 ■ 3.06	UNI 
BV17 	BV17 	05.xxxxx.26	UNI  UNI
GV16 		05.xxxxx.30 ■ 3.02	VSA 20 
GV16 	GV16 	05.xxxxx.31	VSA 20  VSA 20

Technische Änderungen vorbehalten

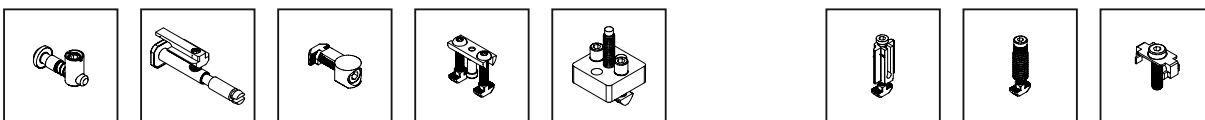

ALU-PROFILE
PROFILES
PROFILES



Konkavität

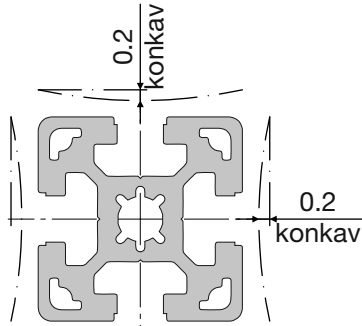

Nut

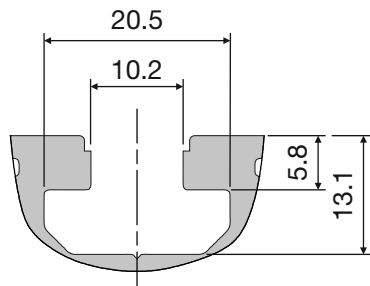

Kernloch

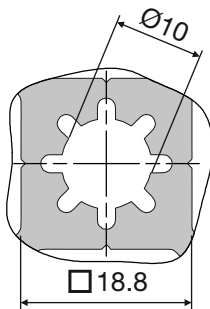

Außenkante

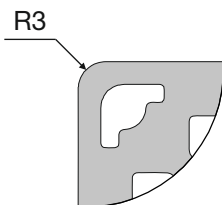

45x45MS-2.1

45x45S

45x60S

45x90S



■ 2.67

■ 2.67

■ 2.67

■ 2.67

60x60S

60x90S

90x90S

90x180S

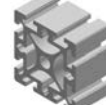
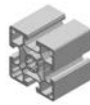

■ 2.68

■ 2.68

■ 2.68

■ 2.69

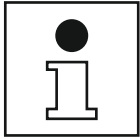

Durchbiegung der Profile
Profile deflection
Flexion des profilés

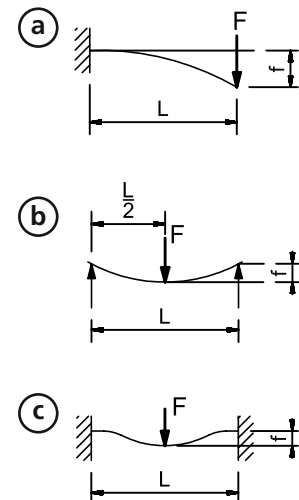
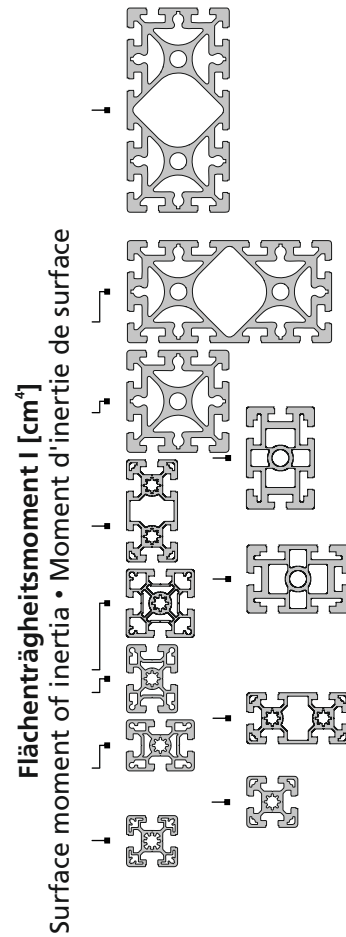
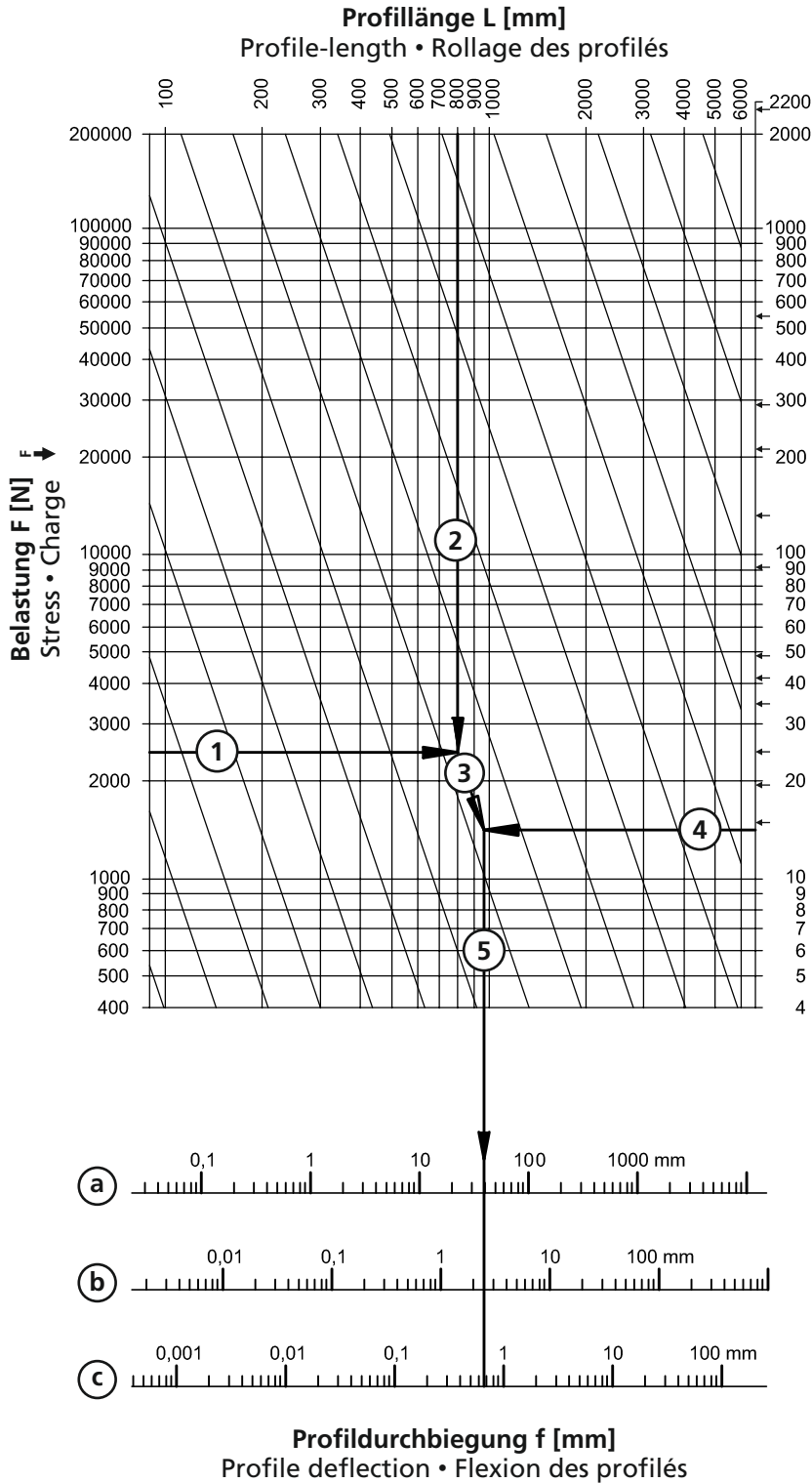

Technische Änderungen vorbehalten

45x45 MS-2.1

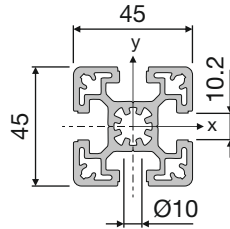
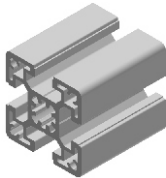

05.01009.00

M = 2,10 kg/m
 $I_x = 15,56 \text{ cm}^4$
 $W_x = 6,92 \text{ cm}^3$
 $I_y = 15,56 \text{ cm}^4$
 $W_y = 6,92 \text{ cm}^3$

PE (m)
 6 / 48 / 96 / 144

45x45 S

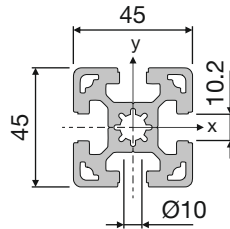
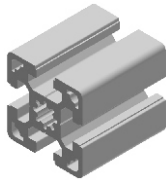

05.01010.00

M = 2,62 kg/m
 $I_x = 18,95 \text{ cm}^4$
 $W_x = 8,42 \text{ cm}^3$
 $I_y = 18,95 \text{ cm}^4$
 $W_y = 8,42 \text{ cm}^3$

PE (m)
 6 / 48 / 96 / 144

45x60 S

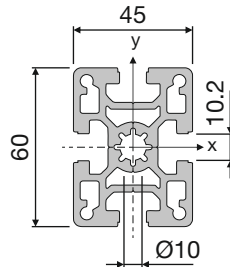
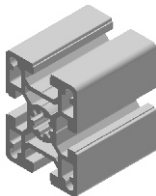

05.01011.00

M = 3,30 kg/m
 $I_x = 41,06 \text{ cm}^4$
 $W_x = 13,69 \text{ cm}^3$
 $I_y = 23,68 \text{ cm}^4$
 $W_y = 10,52 \text{ cm}^3$

PE (m)
 6 / 24 / 48 / 72

45x90 S

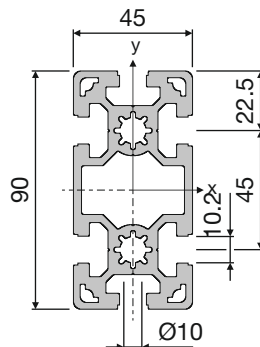
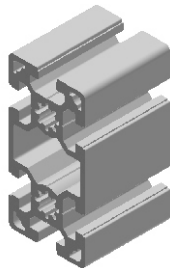

05.01015.00

M = 4,40 kg/m
 $I_x = 134,96 \text{ cm}^4$
 $W_x = 29,99 \text{ cm}^3$
 $I_y = 33,27 \text{ cm}^4$
 $W_y = 14,79 \text{ cm}^3$

PE (m)
 6 / 24 / 48 / 72

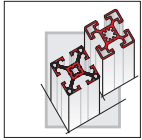

ALU-PROFILE PROFILES PROFILES



60x60 S

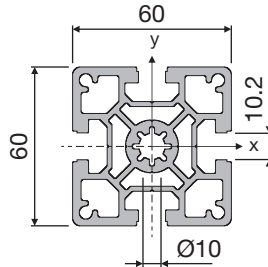
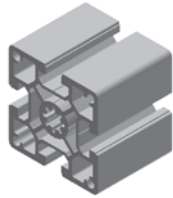

05.01017.00

$M = 3,82 \text{ kg/m}$
 $I_x = 48,36 \text{ cm}^4$
 $W_x = 16,12 \text{ cm}^3$
 $I_y = 48,36 \text{ cm}^4$
 $W_y = 16,12 \text{ cm}^3$

PE (m)
 6 / 18 / 36 / 54

60x90 S

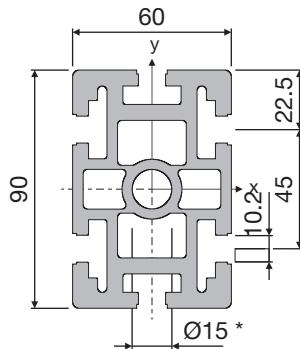
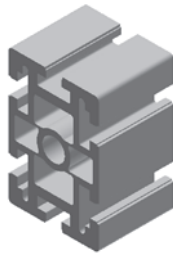

05.01016.00

$M = 6,87 \text{ kg/m}$
 $I_x = 215,97 \text{ cm}^4$
 $W_x = 47,99 \text{ cm}^3$
 $I_y = 91,41 \text{ cm}^4$
 $W_y = 30,47 \text{ cm}^3$

PE (m)
 6 / 18 / 36 / 54

*

Gewinde M16 im Kernloch Ø15 nur mit Gewindeformwerkzeug fertigen!

Only manufacture the M16 thread in the core hole with a diameter of 15 using a thread forming tool!

Produire le filetage M16 avec trou de noyau de Ø15 uniquement avec un outil de taraudage !

90x90 S

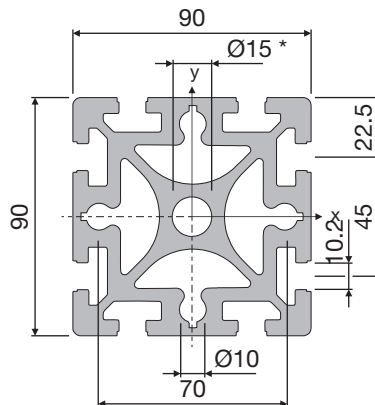
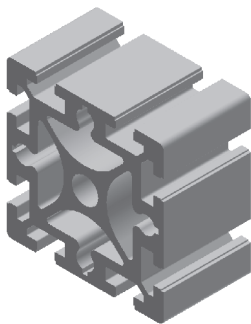

05.01018.00

$M = 10,43 \text{ kg/m}$
 $I_x = 298,12 \text{ cm}^4$
 $W_x = 66,25 \text{ cm}^3$
 $I_y = 298,12 \text{ cm}^4$
 $W_y = 66,25 \text{ cm}^3$

PE (m)
 6 / 24 / 48 / 72

*

Gewinde M16 im Kernloch Ø15 nur mit Gewindeformwerkzeug fertigen!

Only manufacture the M16 thread in the core hole with a diameter of 15 using a thread forming tool!

Produire le filetage M16 avec trou de noyau de Ø15 uniquement avec un outil de taraudage !

ALU-PROFILE
PROFILES
PROFILES



90x180 S

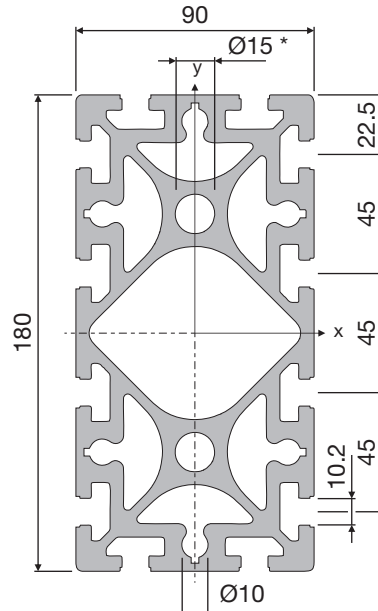
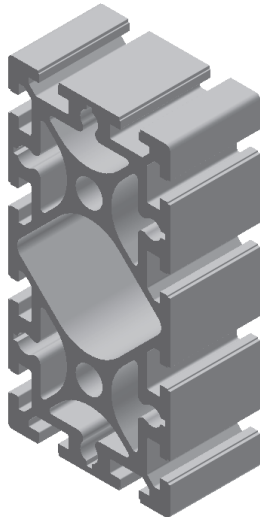

05.01019.00

M	=	17,57	kg/m
I _x	=	2180,42	cm ⁴
W _x	=	242,27	cm ³
I _y	=	557,95	cm ⁴
W _y	=	123,99	cm ³
PE (m)		6 / 12 / 24 / 36	

*
Gewinde M16 im Kernloch Ø15 nur mit Gewindeformwerkzeug fertigen!
 Only manufacture the M16 thread in the core hole with a diameter of 15 using a thread forming tool!
 Produire le filetage M16 avec trou de noyau de Ø15 uniquement avec un outil de taraudage !

2

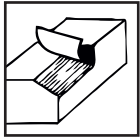

PROFILBEARBEITUNG

PROFILE FINISHING

USINAGE DE PROFILES



1x 45x45	1x 45x60	2x 45x90	1x 60x60	1x 60x90	1x 90x90	2x 90x180
05.xxxxx.09						
M12x60	05.xxxxx.10		M16x115	05.xxxxx.12		
M12x60 M12x60	05.xxxxx.11		M16x115 M16x115	05.xxxxx.13		

45x45	45x60	45x90	60x60	60x90	90x90	90x180
VSI 9.5	05.xxxxx.15 ■ 3.21		AGV	05.xxxxx.35 ■ 3.04		
VSI 9.5 VSI 9.5	05.xxxxx.16		AGV AGV	05.xxxxx.36		
BV17	05.xxxxx.25 ■ 3.06		UNI	05.xxxxx.40 ■ 3.11		
BV17 BV17	05.xxxxx.26		UNI UNI	05.xxxxx.41		
GV16	05.xxxxx.30 ■ 3.02		VSA 20	05.xxxxx.45 ■ 3.20		
GV16 GV16	05.xxxxx.31		VSA 20 VSA 20	05.xxxxx.46		

45x90

BV17V	05.xxxxx.85 ■ 3.06		UNI	05.xxxxx.43 ■ 3.11		
BV17V BV17V	05.xxxxx.86		UNI UNI	05.xxxxx.44		

Technische Änderungen vorbehalten

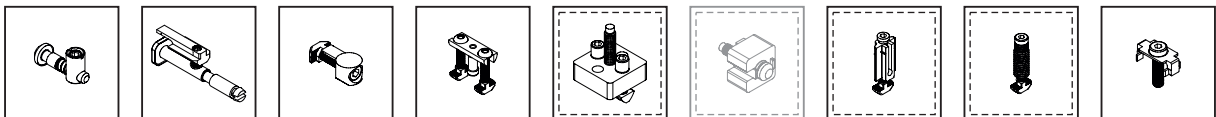

ALU-PROFILE
PROFILES
PROFILES



Konkavität

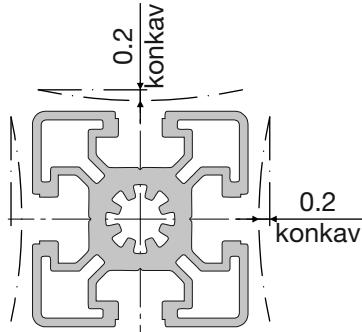

50x50L



■ 2.75

50x100L

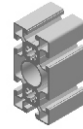

■ 2.75

100x100L

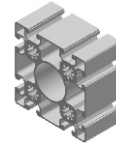

■ 2.75

Nut

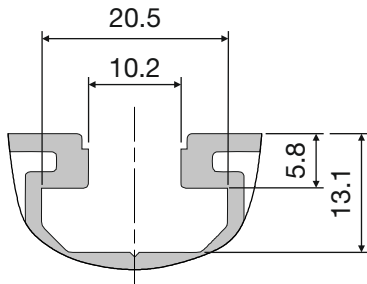

Kernloch

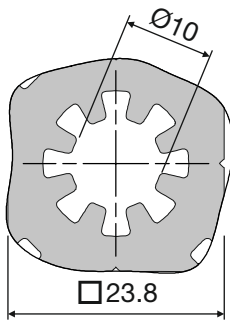

Außenkante

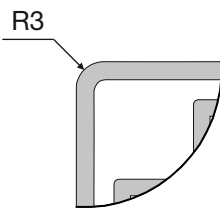

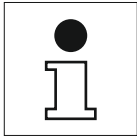

Durchbiegung der Profile
Profile deflection
Flexion des profilés

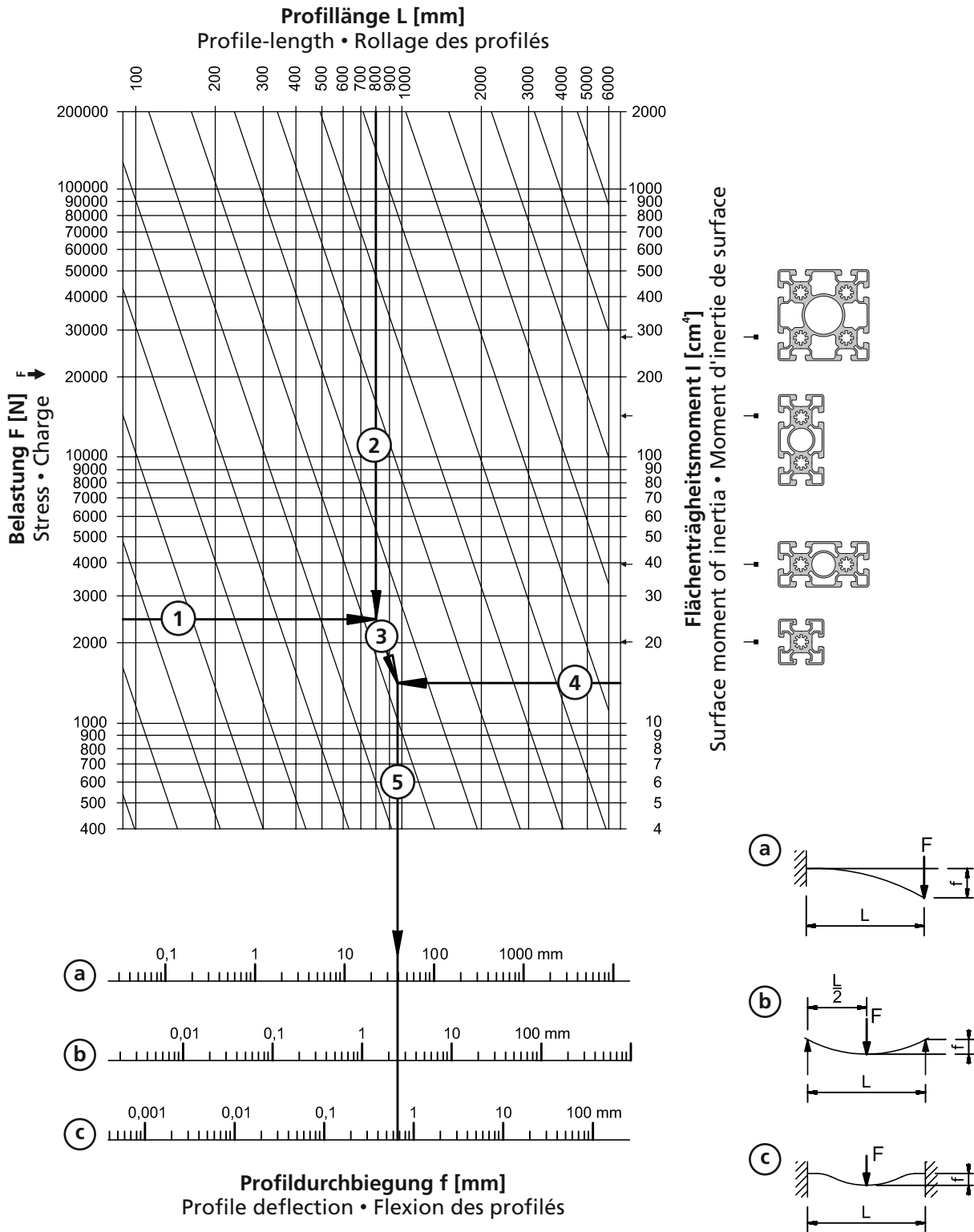

Technische Änderungen vorbehalten

50x50 L

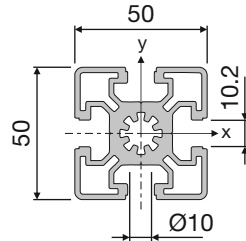
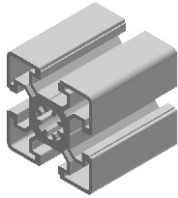

05.01700.00

M = 2,52 kg/m
 $I_x = 19,17 \text{ cm}^4$
 $W_x = 7,67 \text{ cm}^3$
 $I_y = 19,17 \text{ cm}^4$
 $W_y = 7,67 \text{ cm}^3$

PE (m)
 6 / 48 / 96 / 144

50x100 L

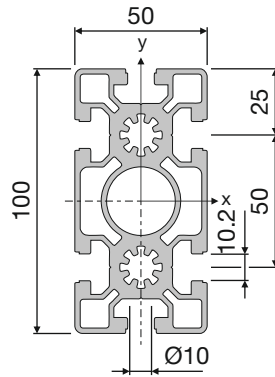
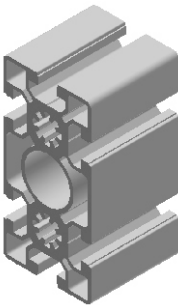

05.01702.00

M = 5,00 kg/m
 $I_x = 166,60 \text{ cm}^4$
 $W_x = 33,32 \text{ cm}^3$
 $I_y = 39,75 \text{ cm}^4$
 $W_y = 15,90 \text{ cm}^3$

PE (m)
 6 / 24 / 48 / 72

100x100 L

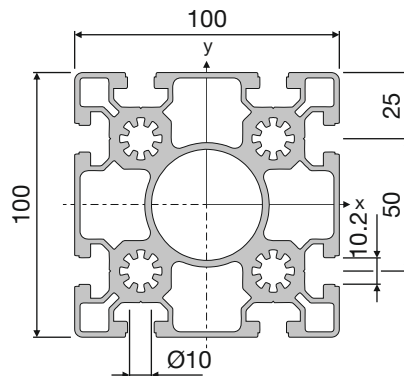
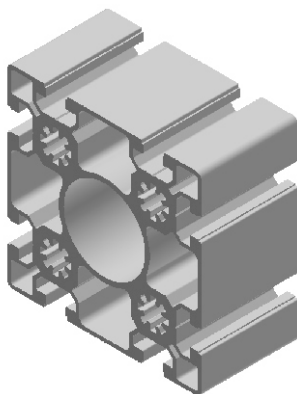

05.01703.00

M = 8,28 kg/m
 $I_x = 293,00 \text{ cm}^4$
 $W_x = 58,60 \text{ cm}^3$
 $I_y = 293,00 \text{ cm}^4$
 $W_y = 58,60 \text{ cm}^3$

PE (m)
 6 / 24 / 48 / 72

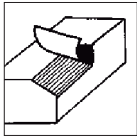

PROFILBEARBEITUNG

PROFILE FINISHING

USINAGE DE PROFILES

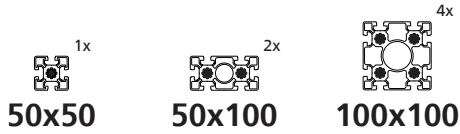

		05.xxxxx.09			
M12x60		05.xxxxx.10		M16x115	
M12x60		05.xxxxx.11		M16x115	

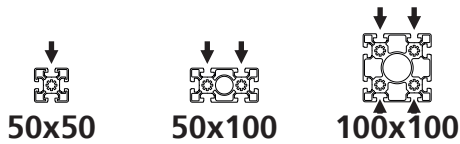

VSI 9.5		05.xxxxx.15	■ 3.21	AGV		05.xxxxx.35	■ 3.04
VSI 9.5		05.xxxxx.16		AGV		05.xxxxx.36	
BV17		05.xxxxx.25	■ 3.06	UNI		05.xxxxx.40	■ 3.11
BV17		05.xxxxx.26		UNI		05.xxxxx.41	
GV16		05.xxxxx.30	■ 3.02	VSA 20		05.xxxxx.45	■ 3.20
GV16		05.xxxxx.31		VSA 20		05.xxxxx.46	



BV17V		05.xxxxx.85	■ 3.06	UNI		05.xxxxx.43	■ 3.11
BV17V		05.xxxxx.86		UNI		05.xxxxx.44	

Technische Änderungen vorbehalten

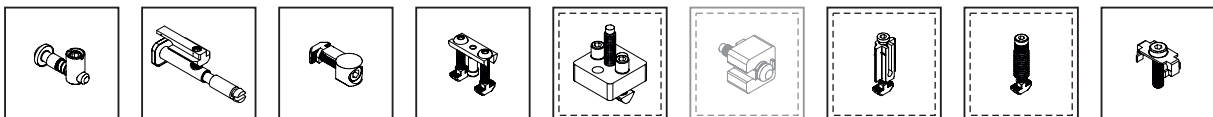

Konkavität

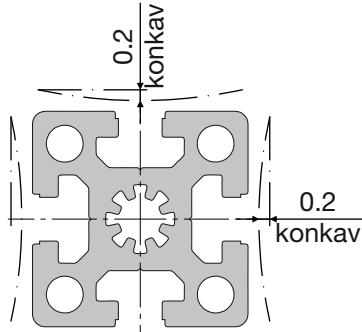

50x50S	50x100S	100x100S
■ 2.77	■ 2.77	■ 2.77

Nut

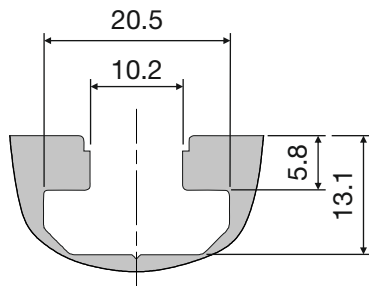

Kernloch

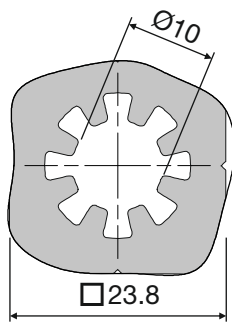

Außenkante

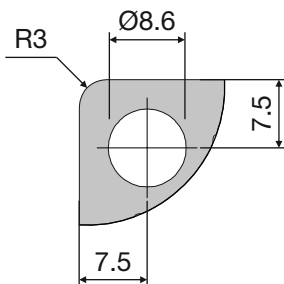

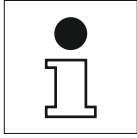

Durchbiegung der Profile
Profile deflection
Flexion des profilés

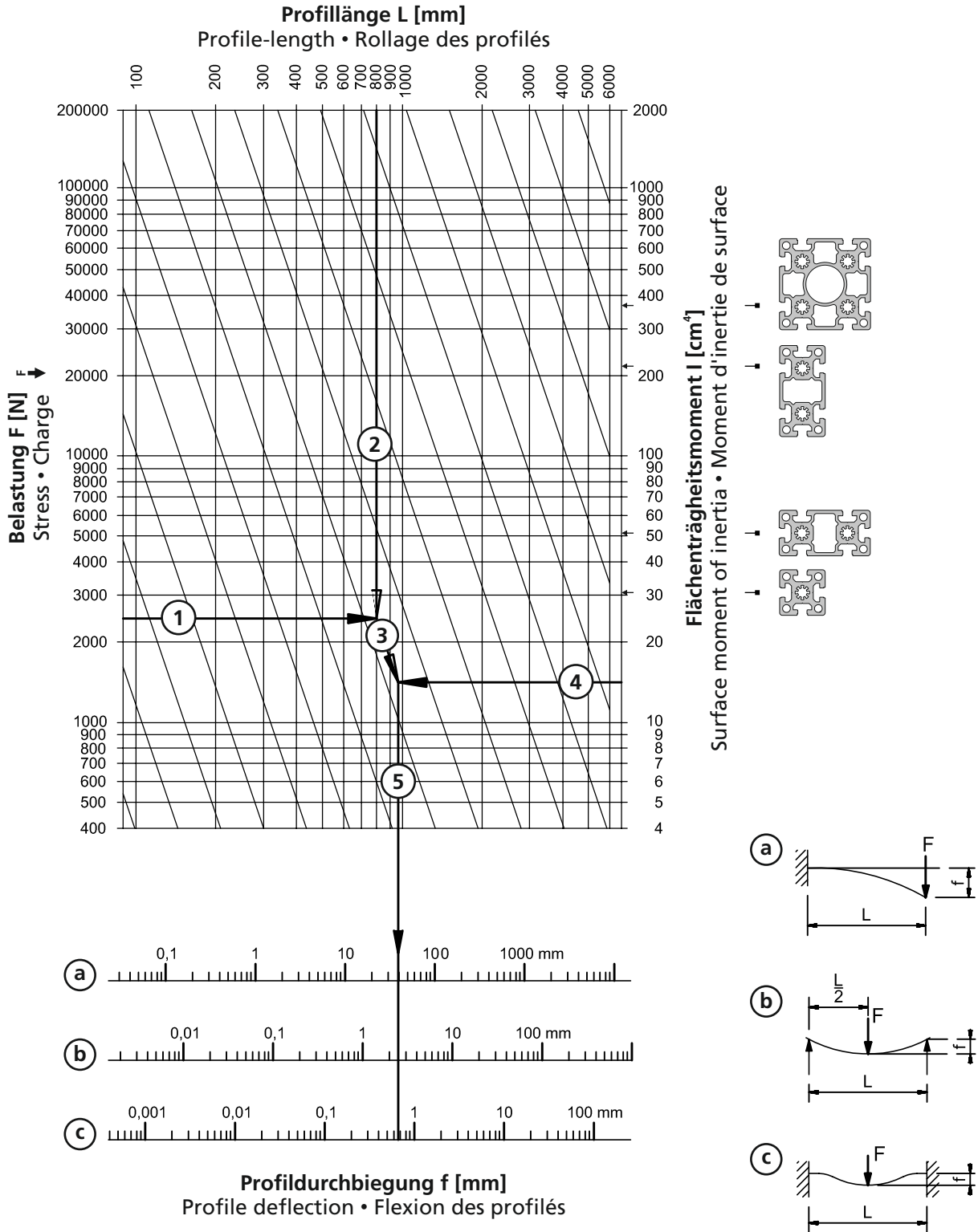

Technische Änderungen vorbehalten

50x50 S

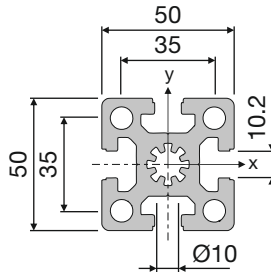
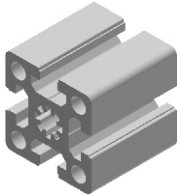

05.01705.00

M = 3,54 kg/m
 $I_x = 29,62 \text{ cm}^4$
 $W_x = 11,85 \text{ cm}^3$
 $I_y = 29,62 \text{ cm}^4$
 $W_y = 11,85 \text{ cm}^3$

PE (m)
 6 / 48 / 96 / 144

50x100 S

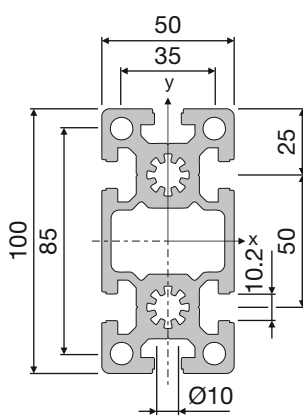
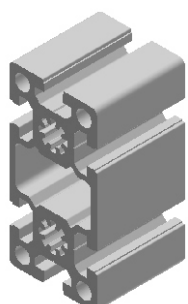

05.01706.00

M = 5,92 kg/m
 $I_x = 219,85 \text{ cm}^4$
 $W_x = 43,97 \text{ cm}^3$
 $I_y = 52,23 \text{ cm}^4$
 $W_y = 20,89 \text{ cm}^3$

PE (m)
 6 / 24 / 48 / 72

100x100 S

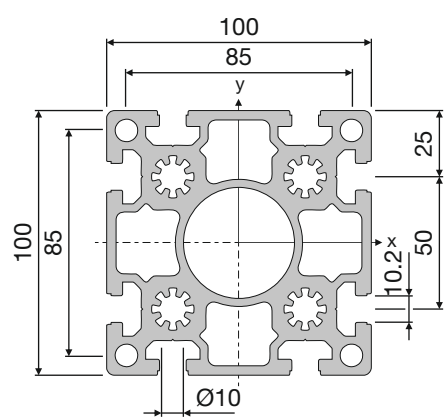
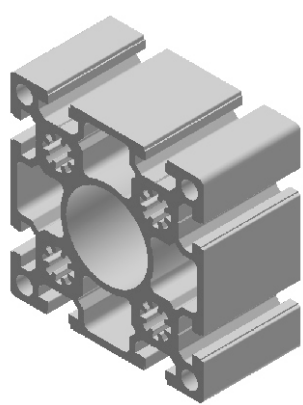

05.01707.00

M = 10,45 kg/m
 $I_x = 383,00 \text{ cm}^4$
 $W_x = 76,60 \text{ cm}^3$
 $I_y = 383,00 \text{ cm}^4$
 $W_y = 76,60 \text{ cm}^3$

PE (m)
 6 / 24 / 48 / 72

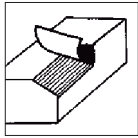

PROFILBEARBEITUNG

PROFILE FINISHING

USINAGE DE PROFILES



	1x 50x50	2x 50x100	4x 100x100	
				05.xxxxx.09
M12x60				05.xxxxx.10
M12x60				05.xxxxx.11
M16x115				05.xxxxx.12
M16x115				05.xxxxx.13

	↓ 50x50	↓ ↓ 50x100	↓ ↓ 100x100	
VSI 9.5				05.xxxxx.15 ■ 3.21
VSI 9.5				05.xxxxx.16
BV17				05.xxxxx.25 ■ 3.06
BV17				05.xxxxx.26
GV16				05.xxxxx.30 ■ 3.02
GV16				05.xxxxx.31
AGV				05.xxxxx.35 ■ 3.04
AGV				05.xxxxx.36
UNI				05.xxxxx.40 ■ 3.11
UNI				05.xxxxx.41
VSA 20				05.xxxxx.45 ■ 3.20
VSA 20				05.xxxxx.46

↔ 50x100

BV17V		05.xxxxx.85 ■ 3.06	UNI		05.xxxxx.43 ■ 3.11
BV17V		05.xxxxx.86	UNI		05.xxxxx.44

Technische Änderungen vorbehalten

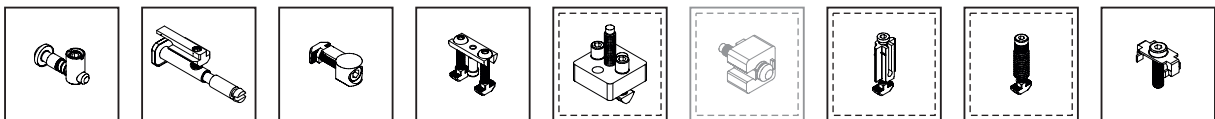















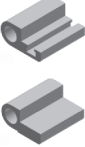







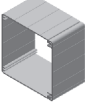





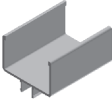

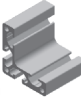
ZUSATZ-PROFILE

ADDITIONAL PROFILES

PROFILES COMPLEMENTAIRES



					
■ 2.81	■ 2.81	■ 2.81	■ 2.82	■ 2.82	■ 2.82
					
➔ ■ 8.10	➔ ■ 8.36	➔ ■ 8.15	➔ ■ 8.29	➔ ■ 8.29	➔ ■ 8.30
					
➔ ■ 9.06	➔ ■ 9.06	➔ ■ 9.06	➔ ■ 9.07	➔ ■ 9.07	➔ ■ 9.07
					
➔ ■ 11.05	➔ ■ 11.05	➔ ■ 11.05	➔ ■ 11.16	➔ ■ 11.18	
					
➔ ■ 12.02	➔ ■ 12.08	➔ ■ 12.08	➔ ■ 12.08	➔ ■ 12.09	➔ ■ 7.07
					
➔ ■ 13.02	➔ ■ 13.17	➔ ■ 13.17	➔ ■ 13.19		

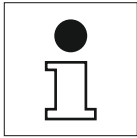

Durchbiegung der Profile
Profile deflection
Flexion des profilés

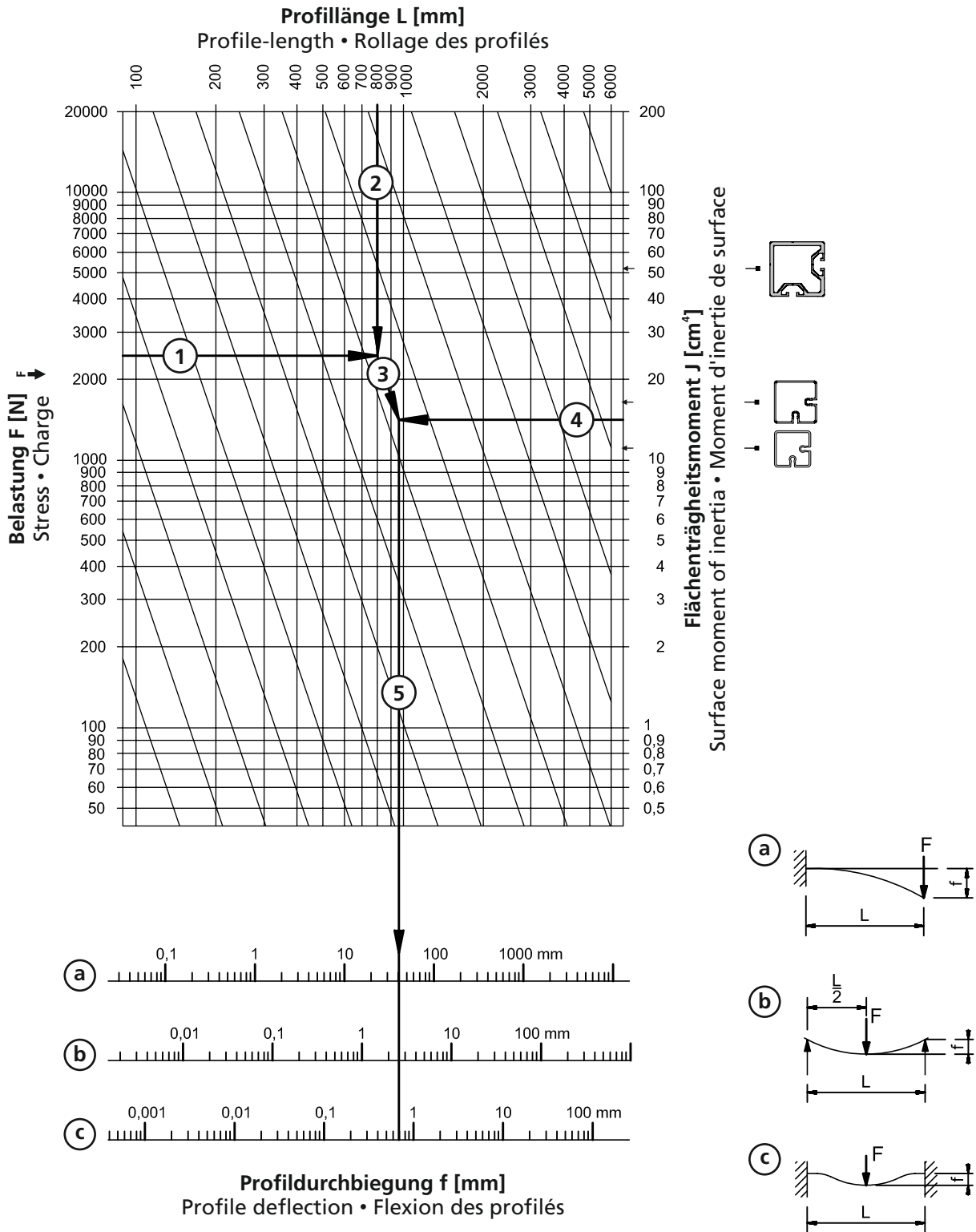

TELESKOPPROFILE
TELESCOPE PROFILES
PROFILES TELESCOPIQUES



40/45

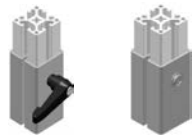
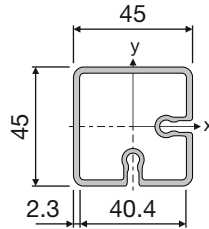
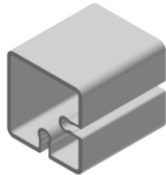

05.01946.00

M = 1,20 kg/m
 $I_x = 11,80 \text{ cm}^4$
 $W_x = 5,24 \text{ cm}^3$
 $I_y = 11,80 \text{ cm}^4$
 $W_y = 5,24 \text{ cm}^3$

PE (m)
 6 / 48 / 96

M8 L=65mm



05.01971.00

M8 x 14



05.01436.00



05.01652.00

45/50

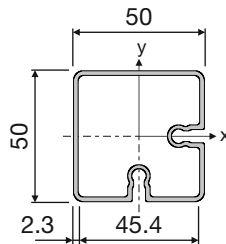
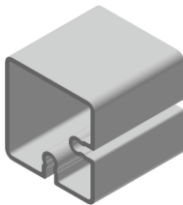

05.01947.00

M = 1,40 kg/m
 $I_x = 17,07 \text{ cm}^4$
 $W_x = 7,59 \text{ cm}^3$
 $I_y = 17,07 \text{ cm}^4$
 $W_y = 7,59 \text{ cm}^3$

PE (m)
 6 / 48 / 96

M8 L=65mm



05.01971.00

M8 x 14



05.01436.00



05.01064.00

60x60

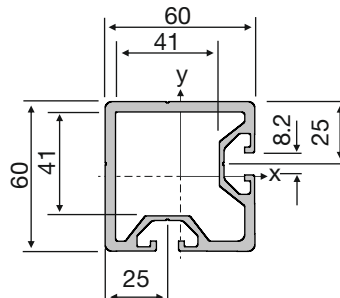
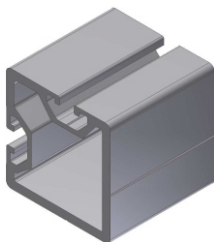

05.01951.00

M = 3,02 kg/m
 $I_x = 52,04 \text{ cm}^4$
 $W_x = 17,28 \text{ cm}^3$
 $I_y = 53,06 \text{ cm}^4$
 $W_y = 17,63 \text{ cm}^3$

PE (m)
 6

Technische Änderungen vorbehalten

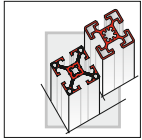

WINKELPROFILE
ANGLE PROFILES
PROFILES D'EQUERRE



35x35

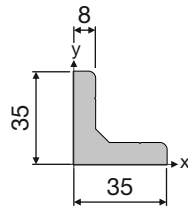
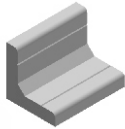

05.01150.00

M = 1,37 kg/m
 $I_x = 11,84 \text{ cm}^4$
 $W_x = 6,77 \text{ cm}^3$
 $I_y = 11,84 \text{ cm}^4$
 $W_y = 6,77 \text{ cm}^3$
 PE (m)
 6 / 48 / 96

98x98

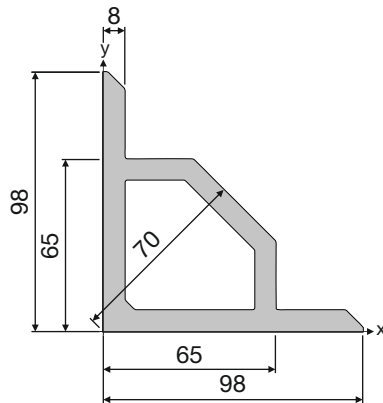
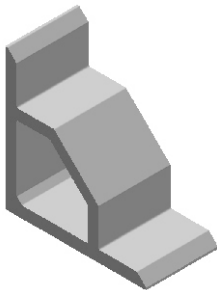

05.01154.00

M = 5,78 kg/m
 $I_x = 380,13 \text{ cm}^4$
 $W_x = 77,58 \text{ cm}^3$
 $I_y = 380,13 \text{ cm}^4$
 $W_y = 77,58 \text{ cm}^3$
 PE (m)
 6 / 24 / 48

45x45

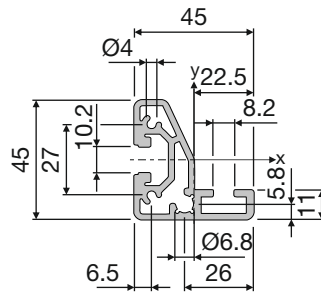
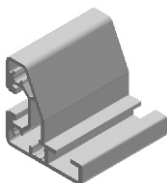

05.01034.00

M = 1,19 kg/m
 $I_x = 9,74 \text{ cm}^4$
 $W_x = 4,33 \text{ cm}^3$
 $I_y = 9,28 \text{ cm}^4$
 $W_y = 4,13 \text{ cm}^3$
 PE (m)
 6 / 48 / 96

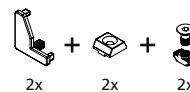
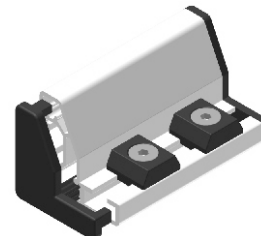
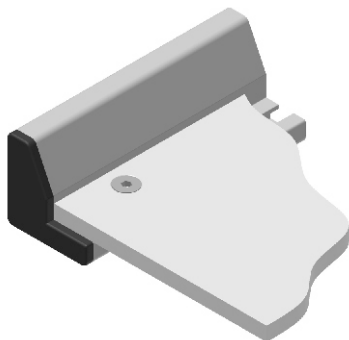

05.01478.00

Technische Änderungen vorbehalten



■ 3.02



■ 3.04



■ 3.05



■ 3.06



■ 3.08



■ 3.10



■ 3.11



■ 3.12



■ 3.14



■ 3.17



■ 3.18



■ 3.17



■ 3.20



■ 3.22



■ 3.25



■ 3.26



■ 3.27



■ 3.29



■ 3.32



■ 3.33



■ 3.34

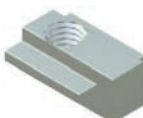

■ 3.34

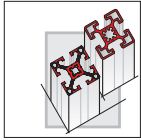

GRUNDVERBINDER BASE CONNECTOR JONCTION DE BASE



GV

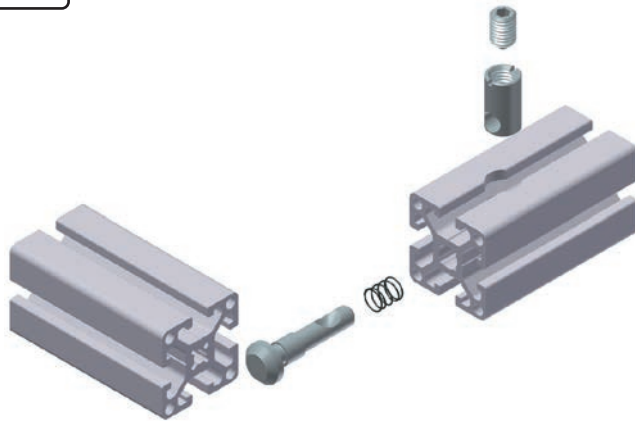

Bestehend aus:
 Hammerbolzen St, vz.
 Hülse St, vz.
 Feder
 Gewindestift

Consisting of:
 Hammerhead bolt St, galv.
 Sleeve St, galv.
 Spring
 Setscrew

Comprenant :
 Pièce d'ancrage Ac, zing.
 Barillet GV Ac, zing.
 Ressort
 Vis pointeau

Innovative Vorteile

- Einfache und schnelle Montage
- Ringschneiden an Verbinderkopf (GV-0)
- Elektrisch leitfähige Verbindung
- Hohe Vielfalt der Verbinderfamilie
- Als Außen- und Innenverbindung einsetzbar

Innovative advantages

- Easy and fast fitting
- Cutting edge on connector head (GV-0)
- Electrical conductive connector
- Highly versatile connector family
- Can be used as inner-fitting and outerfitting connector

Atouts novateurs

- Montage rapide et simple
- Empreinte anti-glissement (GV-0)
- Assemblage conducteur
- Positionnement réglable et universel
- Etude simplifiée

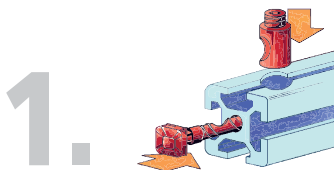

1. ... einsetzen
 insert
 insérer

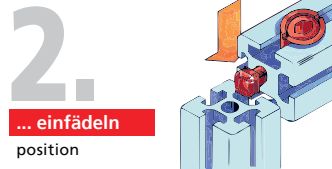

2. ... einfädeln
 position
 glisser

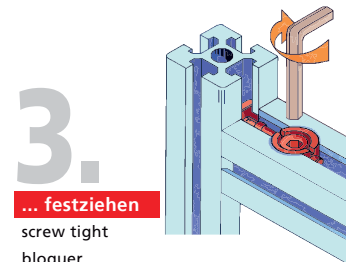

3. ... festziehen
 screw tight
 bloquer

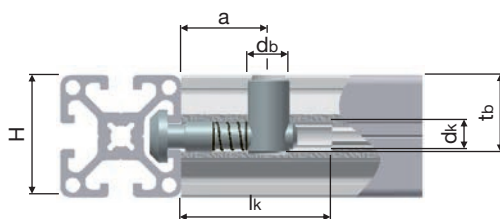

H	d _b	d _k	a	t _b	l _k
	Ø7.5	Ø5.0	15	14.3	30
	Ø10.5	Ø6.8	18	22	-
	Ø14.2	Ø10.2	29	20.5	-
	Ø14.2	Ø10.2	29	26	45
	Ø14.2	Ø10.2	29	26	-
	Ø16.2	Ø10.2	29	30	-
	Ø16.2	Ø10.2	29	32.5	-

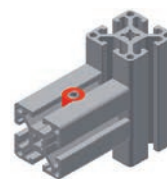

Innenliegende Verbindung
 Inner-fitting connector
 Positionnement interne

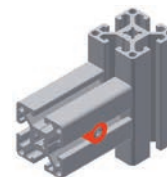

Außenliegende Verbindung
 Outer-fitting connector
 Positionnement externe

➔ ■ 14.01

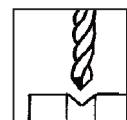

GRUNDVERBINDER

BASE CONNECTOR

JONCTION DE BASE



5 8E 8 10

GV-0

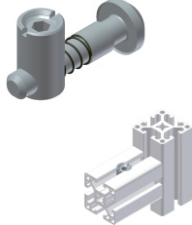

	15Nm	05.01590.00
	19Nm	05.02150.00
	26Nm	05.01596.00
	30Nm	05.01351.00
	35Nm	05.01352.00
	35Nm	05.01270.00

GV-01

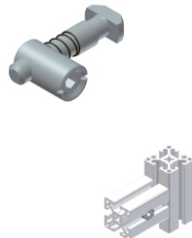

	26Nm	05.01597.00
	33Nm	05.01110.00
	35Nm	05.01112.00
	35Nm	05.01271.00

GV-02

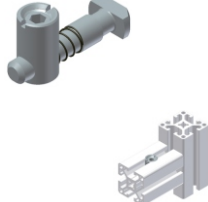

	26Nm	05.01598.00
	33Nm	05.01111.00
	35Nm	05.01113.00
	35Nm	05.01272.00

GS-01

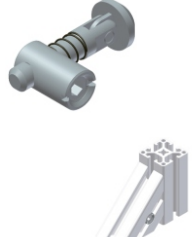

	26Nm	05.02243.00
	12Nm	05.01353.00
	15Nm	05.01357.00
	13Nm	05.01357.50

GS-02

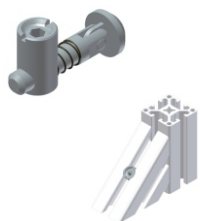

	10Nm	05.02244.00
	12Nm	05.01354.00
	15Nm	05.01358.00
	13Nm	05.01361.00

GGV-01

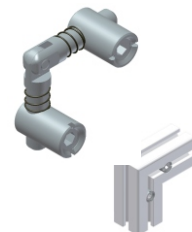

	10Nm	05.02245.00
	12Nm	05.01585.00
	15Nm	05.01553.00
	13Nm	05.01557.00

GGV-02

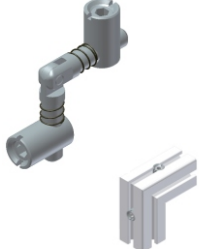

	10Nm	05.02246.00
	12Nm	05.01586.00
	15Nm	05.01554.00
	13Nm	05.01555.00

GST

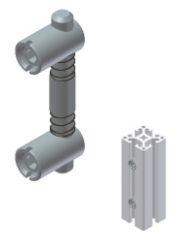

	26Nm	05.02247.00
	33Nm	05.01355.00
	35Nm	05.01359.00
	35Nm	05.01359.50

GSR

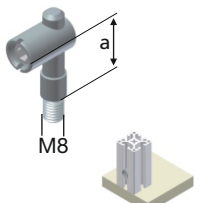

M8
a

	26Nm	05.02248.00
	33Nm	05.01356.00
	35Nm	05.01360.00
	35Nm	05.01360.50

GVP

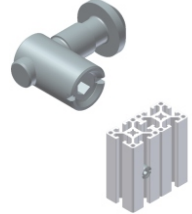

	26Nm	05.02249.00
	33Nm	05.01445.00
	35Nm	05.01556.00
	35Nm	05.01556.50

3

Technische Änderungen vorbehalten

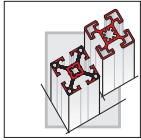

AUTOMATIK-GV

AUTOMATIC - BC (BASIC CONNECTOR)

GV AUTOMATIQUE



AGV

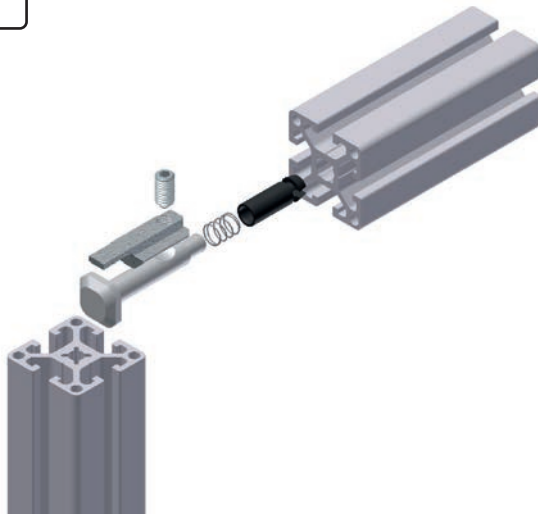

- Bestehend aus:
- AGV-Stein GD-Zn
 - Druckfeder
 - Federhülse PA
 - Hammerbolzen St, vz.
 - Gewindestift
- Consisting of:
- AGV block GD-Zn
 - Compression spring
 - Spring sleeve PA
 - Hammerhead bolts St, galv.
 - Setscrew
- Comprenant :
- Pièce d'ancrage AGV GD-Zn
 - Ressort
 - Manchon sur ressort PA
 - Coulisseau AGV Ac, zing.
 - Vis pointeau

Innovative Vorteile

- Sehr einfache und schnelle Montage
- Automatische Zentrierung
- Geringe Profilbearbeitung
- Verdrehgesichert durch Kopfform
- Ringschneide an Verbinderkopf
- Elektrische Leitfähigkeit
- Positionsgerechte, automatische Fügstellung

Innovative advantages

- Quick and easy to fit
- Automatic centring
- Minimum work on profile
- Head design prevents twisting
- Cutting edge on connector head
- Electrically conductive
- Automatic correct joint positioning

Atouts novateurs

- Montage très simple et rapide
- Auto-positionnement de l'ancrage
- Usinage minime du profilé
- Anti-rotation du profilé
- Empreinte anti-glissement
- Assemblage conducteur
- Autocentrage

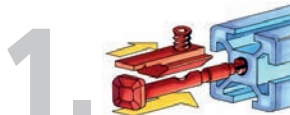

1. ... einschieben

push in
insérer



2. ... platzieren

position
positioner



3. ... festziehen

screw tight
bloquer

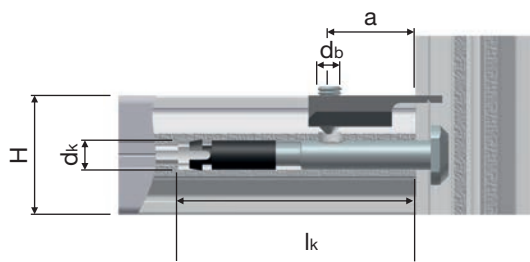

H	d _b	d _k	a	l _k	Nm
30 8E	Ø5.4	Ø6.8	18	-	10
30 8K	Ø7.6	Ø10.2	30	-	15
40 8	Ø7.6	Ø10 *	30	80	15
40 8	Ø7.6	Ø10.2	30	-	15
45 10	Ø9.6	Ø10.2	30	-	25
50 10	Ø9.6	Ø10.2	30	-	25

- 30 8E 05.01780.00 ohne Federhülse
- 30 8K 05.02242.00 ohne Federhülse
- 40 40 8 05.01781.10
- 45 10 05.01782.10
- 50 10 05.01757.00

* = Aufbohren des Kernlochs mit d_k

* = Drilling the core hole with d_k

* = Le forage du trou de base avec d_k

➔ ■ 14.01



Technische Änderungen vorbehalten

HÜLSENVERBINDER

SLEEVE CONNECTORS

FIXATION - HV



HV

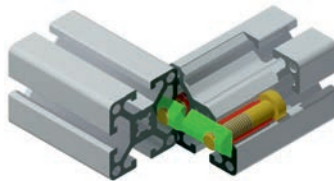

Bestehend aus:
Hülse, SF ISO-Schraube
Nutenstein

St, vz.
St, vz.
St, vz.

Consisting of:
Sleeve, SF ISO screw
Sliding block

St, galv.
St, galv.
St, galv.

HV-Stoßverbinder

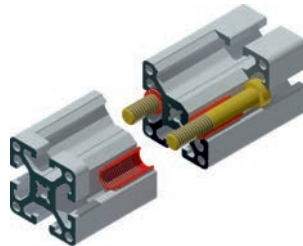

Comprenant:
Douilles-insert
Vis ISO
Coulisseau

Ac, zing.
Ac, zing.
Ac, zing.



Innovative Vorteile

- Hülse selbstzentrierend durch langen Zentrierschaft
- Keine Profilbearbeitung
- Leichtes Eindrehen der Hülse durch Selbstfurchende Gewindeform "FM-Spezial" und Gleit-Mo-Beschichtung
- Hohe Verbindungsfestigkeit
- Stabile, verdrehgesicherte Verbindung
- Elektrische Leitfähigkeit

Innovative advantages

- Sleeve self-centring with long centring shaft
- No work on profiles
- Self-tapping thread "FM-Spezial" and Gleit-Mo coating make it easier to screw in sleeves
- High connecting strength
- Sturdy, non-twisting connection
- Electrically conductive

Atouts novateurs

- Insert autocentreur
- Aucun usinage du profilé
- Vissage facile par insert autotaraudeur "FM-Spezial" et enduction GleitMo
- Stabilité impeccable
- Antirotation du profilé
- Assemblage conducteur



1. ... einschrauben
screw in
visser

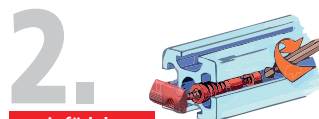

2. ... einfädeln
position
insérer

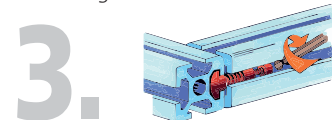

3. ... festziehen
screw tight
bloquer

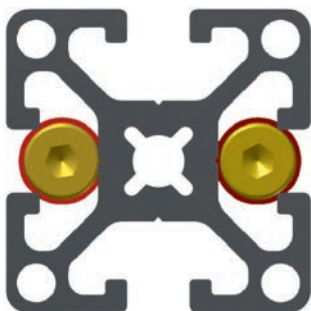

Hülsenverbinder müssen grundsätzlich **PAARWEISE** eingesetzt werden.

Sleeve connectors must be used in **PAIRS**

Utilisation impérative par **PAIRE**

HV



15 Nm				05.02173.10
19 Nm				05.02127.10
22 Nm				05.02128.10 *
25 Nm				05.02129.10 *
25 Nm				05.02129.00

HV-Stoßverbinder

12 Nm				05.02439.00
20 Nm				05.02440.00 *
25 Nm				05.02441.00 *
				05.02126.00

* wird benötigt Sternschlüssel-Bit SX-50

Technische Änderungen vorbehalten

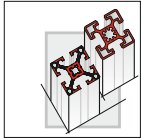

BOLZENVERBINDER BOLT CONNECTOR JONCTION A BOULONS



BV

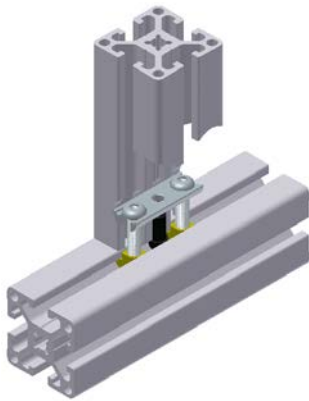

Bestehend aus:
Bolzen St, vz.
ISO-Schrauben
Hammermuttern PA
Fixierbolzen
Abdeckkappen

Consisting of:
Bolts St, galv.
ISO screws
Hammer nuts PA
Fastening bolts
Caps

Comprenant :
Ancrage demi-lune Ac, zing.
Vis ISO
Ecroû de rainure
Centreur PA
Capuchon

Innovative Vorteile

- Sehr hohe Verbindungs- und Verdrehfestigkeit
- Selbstzentrierend durch Zentrierzapfen
- Beidseitig gleichmäßiger Anzug über Hammermuttern
- Leitfähige Verbindung durch Riefen an der Hammermutter

Innovative advantages

- High connecting strength and twist resistance
- Centring pin for self-centring
- Even tightening on both sides with hammer nuts
- Ribbing on hammer nuts for conductive connection

Atouts novateurs

- Stabilité et blocage impeccables
- Autocentrage par pion axial
- Serrage bilatéral uniforme par vis et écrou de rainure
- Assemblage conducteur

1.

... einschieben

push in
insérer

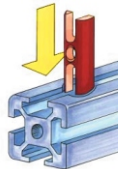

2.

... sichern

secure
sécuriser

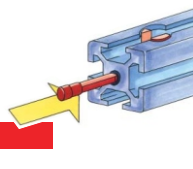

3.

... festziehen

tighten
bloquer

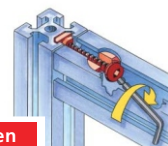

Ausführung

- A** Stahl, verzinkt
Zugfestigkeit ca. 550N/mm²
- B** Zinkdruckguss
Zugfestigkeit ca. 300N/mm²

Design

- A** Galvanized steel
tensile strength 550N/mm²
- B** Zinc diecast
tensile strength 300N/mm²

Matières

- A** Acier zingué
Résistance 550N/mm²
- B** Zamak
Résistance 300N/mm²

H	d _s	a	Nm
30	Ø11.2	18	6
30 ^{lock}	Ø11.2	18	6
40	Ø14.2	20	22
45	Ø17.2	22,5	25
50	Ø17.2	22,5	25

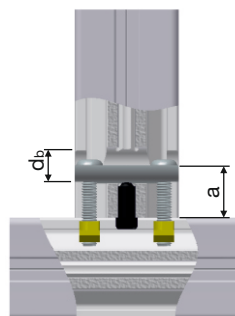

➔ ■ 14.01



Technische Änderungen vorbehalten

BOLZENVERBINDER

BOLT CONNECTOR

JONCTION A BOULONS



8E

8

10

BV Ø11 L=30

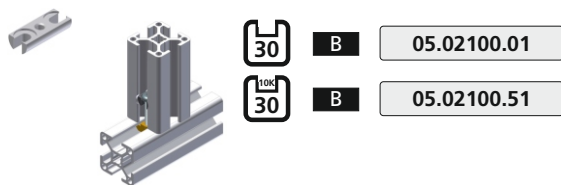

BV Ø11 L=60

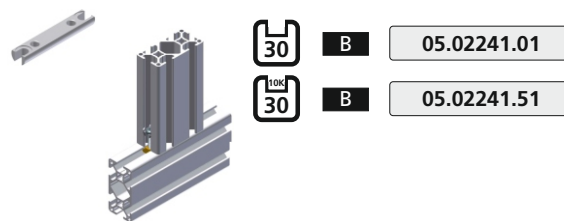

BV Ø14 L=40

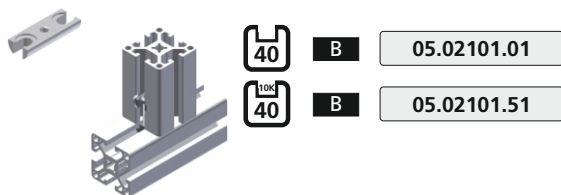

BV Ø14 L=80

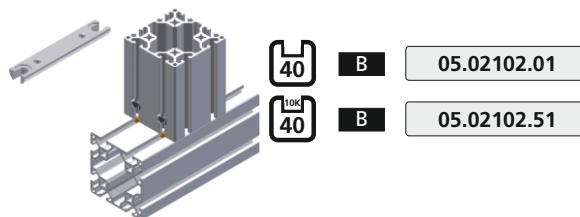

BV Ø17 L=45

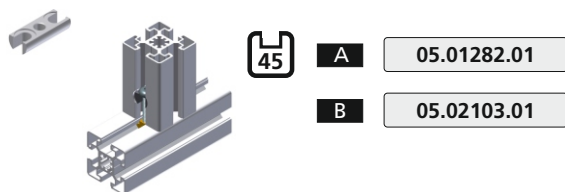

BV Ø17 L=60

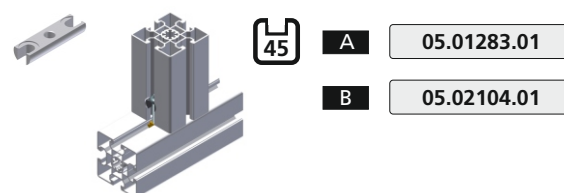

BV Ø17 L=90

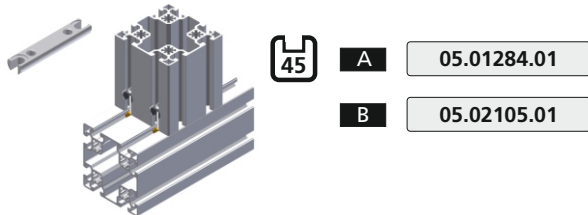

Artikel auf dieser Seite:
PE (St.) = 10

BV Ø17 L=50

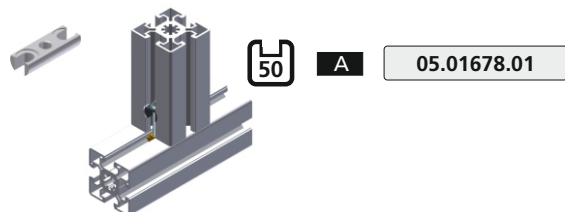

BV Ø17 L=100

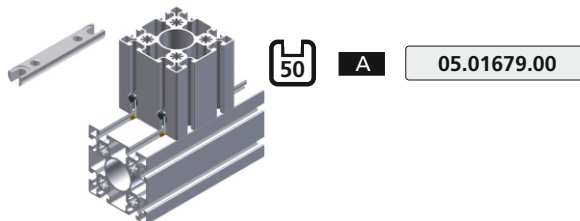

3

Technische Änderungen vorbehalten

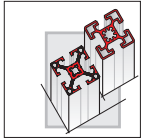

PLATTENVERBINDER PLATE CONNECTOR FIXATION PV



PV

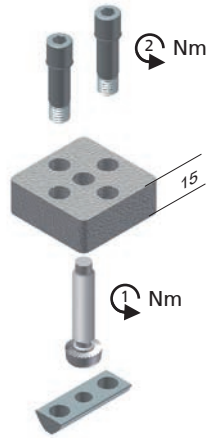
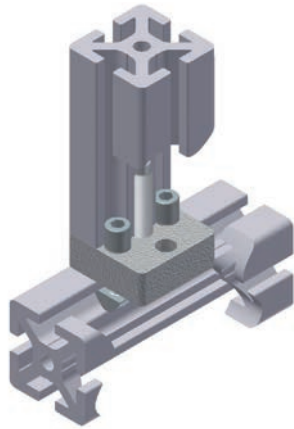

Bestehend aus:
Platte
Passschraube
FM-Schraube
Nutenstein

GD-Zn
St, vz.

Consisting of:
Plate
Set screw
FM screw
Sliding block

GD-Zn
St, galv.

Comprenant :
Platine
Vis épaulée
Vis FM autotaraudeuse
Barrette écrou

GD-Zn
Ac, zing.

Innovative Vorteile

- Einfaches Verbinden ohne Profilbearbeitung
- Leichtes Eindrehen durch selbst-furchende Verbinderschraube mit "FM-Spezial"-Gewinde
- Exakte und automatische Zentrierung
- Schnelle Montage durch vormontierte Einheit
- Leitfähige Verbindung

Innovative advantages

- Easy connection without work on profile
- Self-tapping connector screw with "FM-Spezial"-thread for easy screwing in
- Exact and automatic centring
- Pre-assembled unit for quick fitting
- Conductive connection

Atouts novateurs

- Fixation aisée - aucune opération d'usinage
- Vissage facile par vis autotaraudeuse
- Autocentrage automatique
- Assemblage conducteur
- Compatibilité avec tous profilés et rainures existants

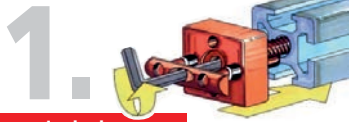

1. ... eindrehen

screw in
visser

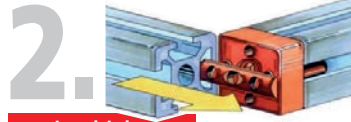

2. ... einschieben

push in
insérer

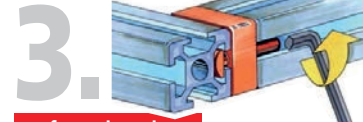

3. ... festschrauben

tighten
bloquer

Ausführung

A Zinkdruckguss
Zugfestigkeit ca. 300N/mm²

B RAL 9006

Design

A Zinc diecast
tensile strength 300N/mm²

B RAL 9006

Matières

A Zamak
Résistance ca. 300N/mm²

B RAL 9006

H	1 Nm	2 Nm
40	25	22
45	35	26
50	35	26

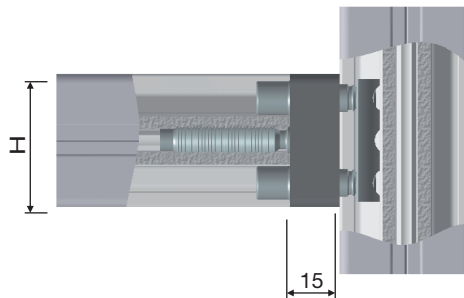

Technische Änderungen vorbehalten

PLATTENVERBINDER

PLATE CONNECTOR

FIXATION PV



40x40

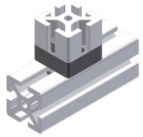

A 05.01760.00

B 05.01760.20



05.01761.00

Eine Nut offen
· One groove open
· Une rainure ouverte

40x80

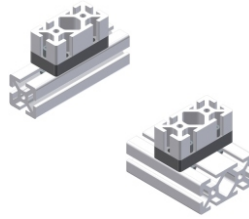

A 05.01762.00

B 05.01762.20

A 05.01762.02

B 05.01762.22

40x120

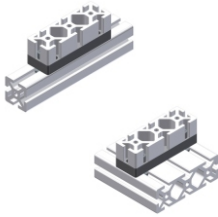

A 05.01689.00

B 05.01689.20

A 05.01689.02

B 05.01689.22

80x80

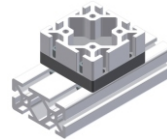

A 05.01764.00

B 05.01764.20

45x45

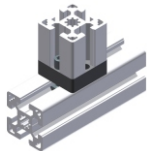

A 05.01766.00

45x60

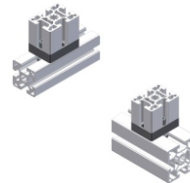

A 05.01699.00

B 05.01699.20

A 05.01768.00

45x90

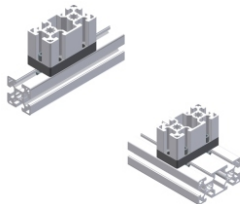

A 05.01769.00

B 05.01769.20

A 05.01769.02

B 05.01769.22

60x60

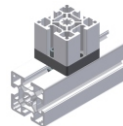

A 05.01770.00

90x90

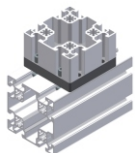

A 05.01772.00

50x50

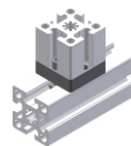

A 05.01680.00

50x100

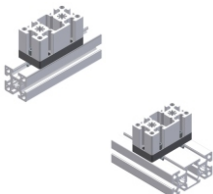

A 05.01682.00

A 05.01682.02

100x100

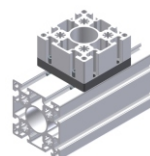

A 05.01683.00

3

Technische Änderungen vorbehalten

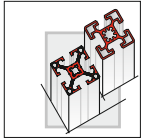

END-VERBINDER END CONNECTOR NOIX TERMINALE - END



END

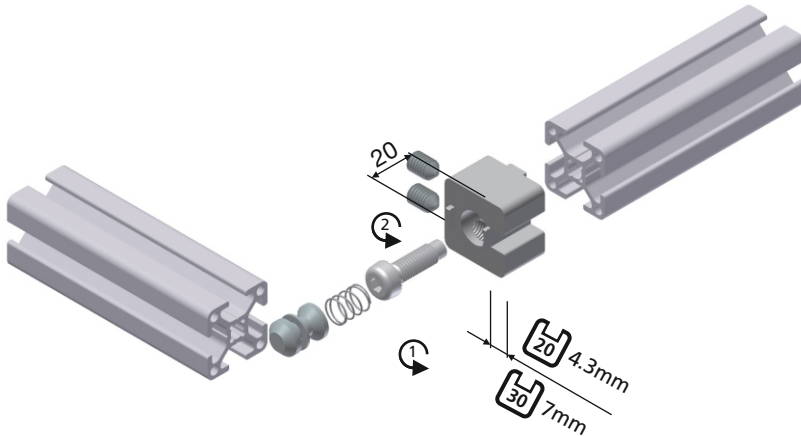

Bestehend aus:	
Grundkörper	GD-Zn
FM-Schraube	St, vz.
Feder	
Gewindestift	
Bolzen	
Consisting of:	
Basic unit	GD-Zn
FM screw	St, galv.
Spring	
Set screw	
Bolts	
Comprenant :	
Noix	GD-Zn
Vis FM autotaraudeuse	
Ressort	Ac, zing.
Pion de guidage	
Vis pointeau	

Innovative Vorteile

- Einfaches verbinden
- Ohne Profilbearbeitung
- Leichtes eindrehen durch selbstfurchende Schraube
- Aufnahme von Flächenelementen

Innovative advantages

- Easy to connect
- Without work on profile
- Easy to screw in self-tapping connecting screw
- Attachment of panel elements

Atouts novateurs

- Fixation aisée
- Aucun usinage
- Vissage facile par vis autotaraudeuse
- Adaptation de panneaux de remplissage

Ausführung

- A** GD-Zn, natur
- B** GD-Zn, RAL 9006

Design

- A** Zinc diecast (GD-Zn), natural
- B** Zinc diecast (GD-Zn), RAL 9006

Matières

- A** Zamak, nature
- B** Zamak, RAL 9006

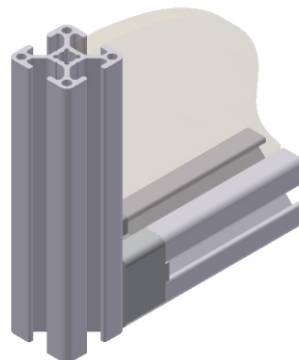
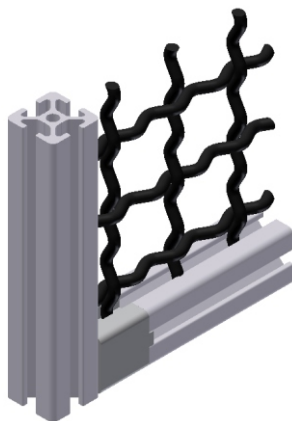

		A	05.01640.00
		B	05.01642.00
			15 Nm
			15 Nm
		A	05.01641.00
		B	05.01643.00
			25 Nm
			18 Nm

Technische Änderungen vorbehalten

UNI-VERBINDER

UNI CONNECTOR

FIXATION UNI



UNI

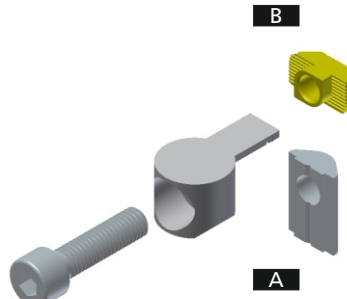
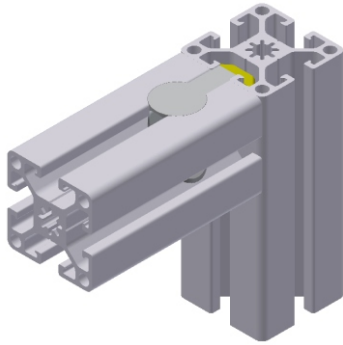

Bestehend aus:
UNI-Verbinderstück GD-Zn
ISO-Schraube St, vz.
Hammermutter oder
Nutenstein

Consisting of:
UNI connector GD-Zn
ISO screw St, galv.
Hammer nuts or
Sliding block

Comprenant :
Barillet UNI GD-Zn
Vis ISO Ac, zing.
Ecroû de rainure ou
Barrette écrou

3

Innovative Vorteile

- Für alle Profilmuten einsetzbar
- Nachträglicher Einbau
- Verdrehgesicherte Verbindung
- Leitfähige Verbindung durch Riefen an der Hammermutter
- Universell einsetzbar, da kombinierbar mit allen Nuten

Innovative advantages

- Suitable for all profile slots
- Retrofittable
- Non-twisting connector
- Ribbing on hammer nut for conductive connection
- Combinable with all slots for universal application

Atouts novateurs

- Positionnement réglable et universel
- Insérable dans une structure sans redémontage
- Anti-rotation du profilé
- Assemblage conducteur
- Compatibilité avec tous profilés et rainures existants

Verbinder sollten **PAARWEISE** eingesetzt werden

Connectors should be used in **PAIRS**

Résistance optimale par **PAIRE**

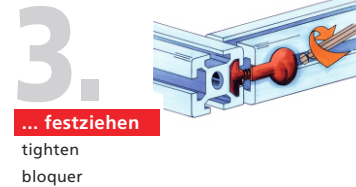
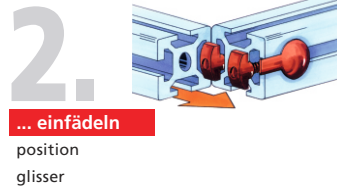
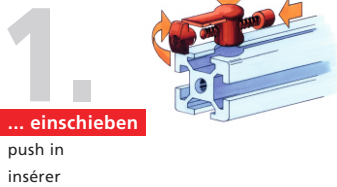

H	D _b	d _b	a	t _b	Nm
20 5	Ø12	Ø4.3	10	8.5	5
30 8E	Ø16	Ø5.5	15	12.7	15
40 8	Ø20	Ø7	20	16	25
45 10	Ø20	Ø7	20	16	30
50 10	Ø20	Ø7	20	16	30

20	5	A	05.01608.00
30	8E	A	05.01609.00
		B	05.01609.50
40	8	A	05.01610.00
		B	05.01610.50
45	10	A	05.01644.00
50	10	B	05.01644.50

→ ■ 14.01



Technische Änderungen vorbehalten

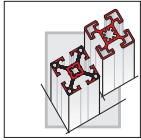

WÜRFELVERBINDER CUBE CONNECTOR RACCORD DE CUBE



- Für verdrehgesicherte Eckverbindungen
- Keine Endenbearbeitung
- Leichtes Eindrehen durch selbstfurchende Verbinderschraube mit "FM-Spezial"-Gewinde

- For non-twisting corner connection
- No work on profile
- Self-tapping screw with "FM-Spezial"- thread for easy screwing in

- Pour jonction antirotation d'angle
- Aucun usinage de profile
- Vissage facile pour vis autotaradeuse

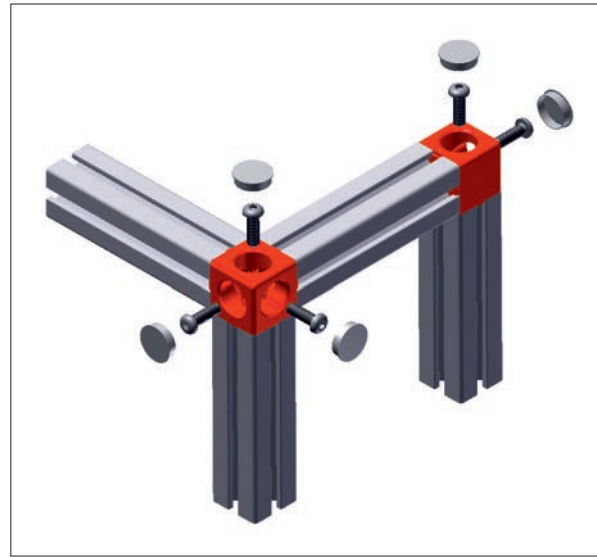

20-90°/2

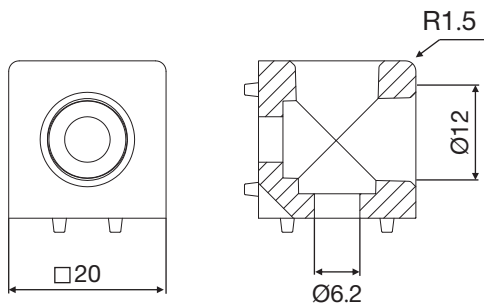

	GD-Al	RAL 9006
	05.02276.00	05.02276.20
	05.02276.05	05.02276.25

20-90°/3

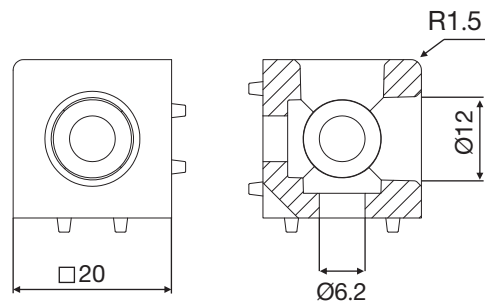

	GD-Al	RAL 9006
	05.02277.00	05.02277.20
	05.02277.05	05.02277.25

30-90°/2

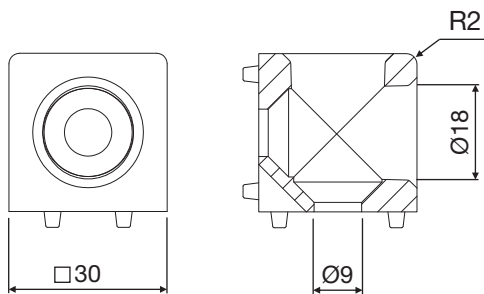

	GD-Al	RAL 9006
	05.02203.00	05.02203.20
	05.02203.05	05.02203.25

30-90°/3

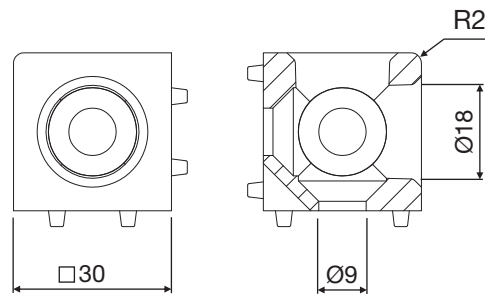

	GD-Al	RAL 9006
	05.02204.00	05.02204.20
	05.02204.05	05.02204.25

Technische Änderungen vorbehalten

WÜRFELVERBINDER

CUBE CONNECTOR

RACCORD DE CUBE



40-90°/2 8

GD-AI RAL 9006

+	05.02205.00	05.02205.20
+ +	05.02205.05	05.02205.25

40-90°/3 8

GD-AI RAL 9006

+	05.02206.00	05.02206.20
+ +	05.02206.05	05.02206.25

45-90°/2 10

GD-AI RAL 9006

+	05.02209.00	05.02209.20
+ +	05.02209.05	05.02209.25

45-90°/3 10

GD-AI RAL 9006

+	05.02210.00	05.02210.20
+ +	05.02210.05	05.02210.25

50-90°/3 10

GD-AI

+ +	05.02212.05
------	-------------

3

Technische Änderungen vorbehalten

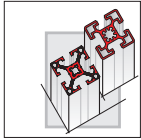

ECKWINKEL 20, 30, 40, 45

3-WAY CONNECTION ANGLE 20, 30, 40, 45

CORNIERE D'ANGLE 20, 30, 40, 45



A GD-Zn

PA6

+

+

5 M 5x16
8E 8 SF 8x40
10 SF 12x40

B GD-Zn

PA6

+

+

5 M 5x16
8E 8 SF 8x40
10 SF 12x40

C GD-Zn

PA6

+

+

8 SF 8x40
10 SF 12x40

20 **30**

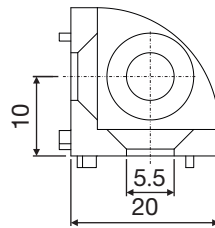
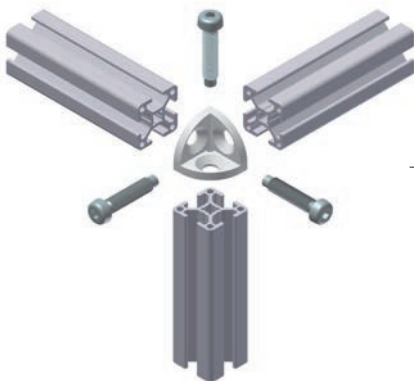

5 A 05.02080.00

5 B 05.02080.10

40 **45**

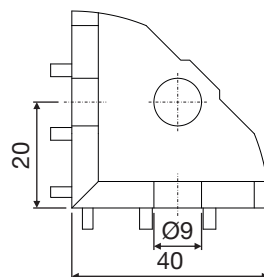
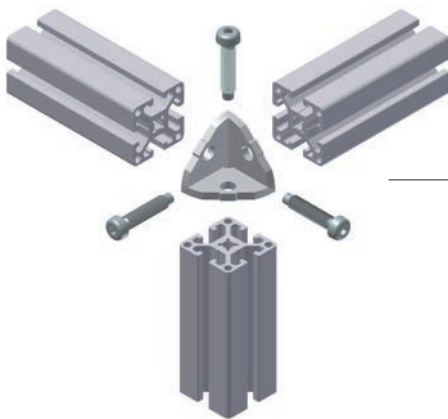

8 A 05.02147.00

8 B 05.02147.10

8 C 05.02147.20

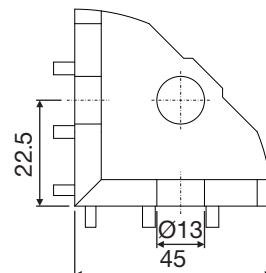

10 A 05.02124.00

10 B 05.02124.10

Technische Änderungen vorbehalten

INNENWINKEL
INTERNAL ANGLE
ANGLE INTÉRIEUR



Typ **A**

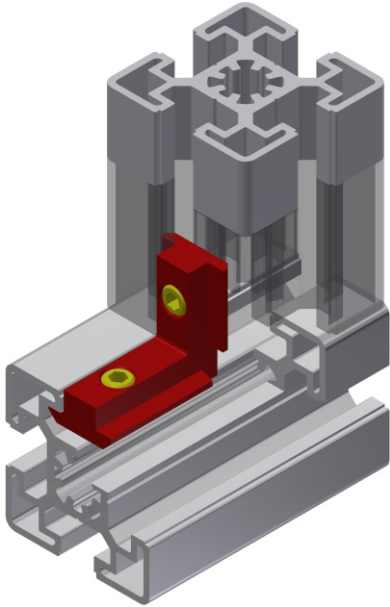

Typ **M**

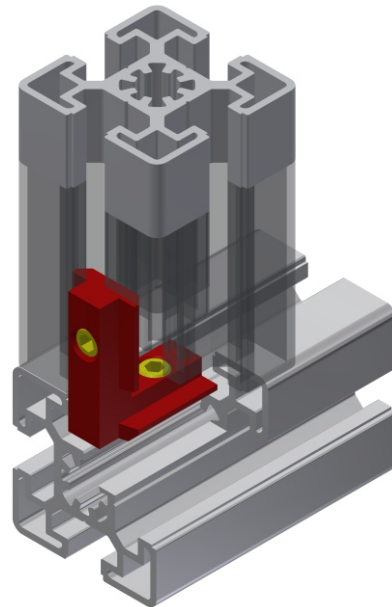

3

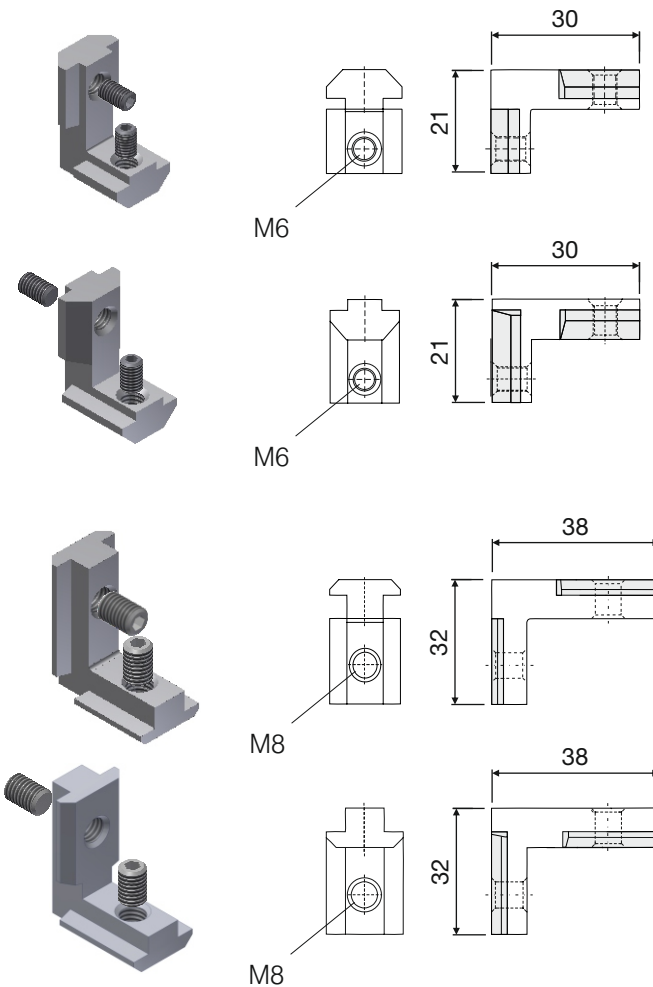

A 40 8 05.02389.00

M 40 8 05.02388.00

A 45 10 05.02391.00

M 45 10 05.02390.00

Technische Änderungen vorbehalten

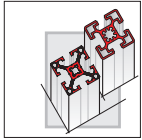

FM-SCHRAUBEN

FM-SCREW

VIS FM



Innovative Vorteile

- Kein Gewinde schneiden
- Selbstfurchende Gewindeform
- Hohe Verbindungsfestigkeit
- Perfektes Handling durch tiefen Innensechskant
- Hohe Sicherung durch starke Sperrverzahnung am Schraubenkopf
- Elektrisch leitfähig

Innovative advantages

- No thread cutting
- Self-tapping thread form
- High connecting strength
- Deep hexagon socket for perfect handling
- Strong lock toothing on screw head for high safety
- Electrically conductive

Atouts novateurs

- Taraudage superflu
- Vissage facile autotaraudeur
- Blocage impeccable
- Serrage optimum - profondeur accentuée du six pans creux
- Blocage grip sous la tête de vis
- Assemblage conducteur

SF 5x16

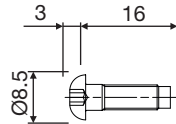

Anwendung

END

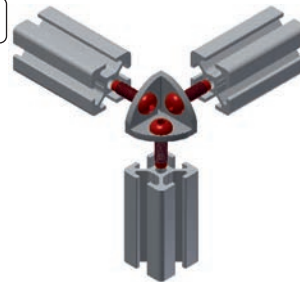

15 Nm

Festigkeitsklasse 8.8
Strength class 8.8
Classification de résistance 8.8

05.01126.00

Senkschb. SF 7,1x30

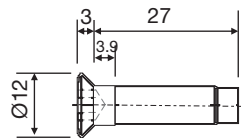

Anwendung

Gelenk

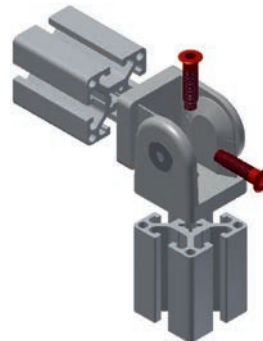

25 Nm

Festigkeitsklasse 8.8
Strength class 8.8
Classification de résistance 8.8

05.01538.00

Flachkopfschb. SF 7,4x30

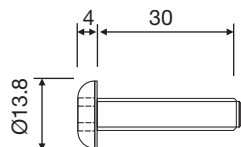

Anwendung

VSI

PV

Gelenk

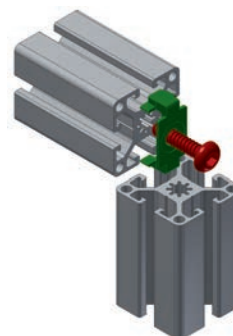

25 Nm

Festigkeitsklasse 8.8
Strength class 8.8
Classification de résistance 8.8

05.01125.50

Technische Änderungen vorbehalten

FM-SCHRAUBEN

FM-SCREW

VIS FM



SF 8x25

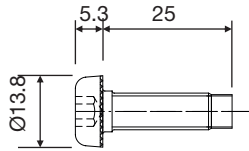

- Anwendung
- VSI
 - PV
 - Gelenk

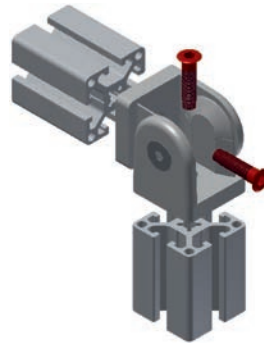

SW5
 25 Nm
 Festigkeitsklasse 8.8
 Strength class 8.8
 Classification de résistance 8.8
 05.01124.00

SF 8x40

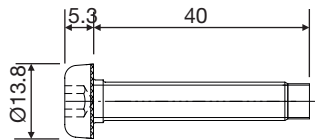

- Anwendung
- VSA

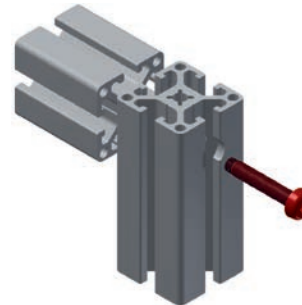

SW5
 25 Nm
 Festigkeitsklasse 8.8
 Strength class 8.8
 Classification de résistance 8.8
 05.01125.00

SF 12x40

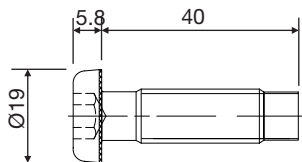

- Anwendung
- PV
 - VSI

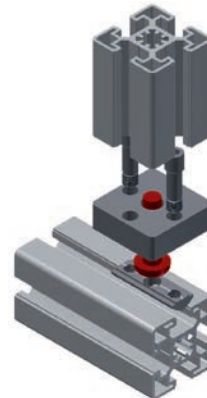

SW8
 35 Nm
 Festigkeitsklasse 8.8
 Strength class 8.8
 Classification de résistance 8.8
 05.01127.00

M12x30*

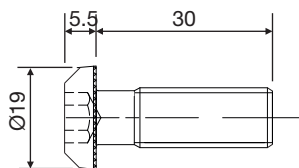

- Anwendung
- VSI

*M12

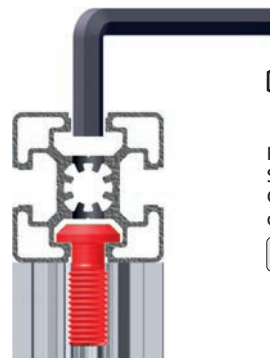

SW8
 40 Nm
 Festigkeitsklasse 8.8
 Strength class 8.8
 Classification de résistance 8.8
 05.01083.00

3

Technische Änderungen vorbehalten

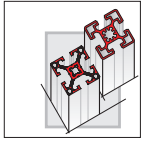

GEHRUNGSVERBINDER

MITRE CONNECTOR

JOINT A ONGLET



Innovative Vorteile

- Gehrungsverbindung von Profilen, die unter 30° bzw. 45° gesägt sind
- Vibrationsfreie Verbindung durch Spezialschrauben

Innovative advantages

- Mitre connector of profiles that are sawn below 30° or 45°
- Special screws for non-vibrating connection

Atouts novateurs

- Assemblages coupés d'onglet à 30° et 45°
- Aucun usinage

Ausführung

Stahlblech, verzinkt

Design

Sheet steel, galv.

Version

Plaque d'acier zinguée

Anwendungsbeispiele
Applications • Applications

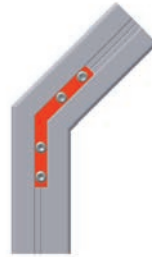

GEV-8

8E
8

05.01290.00

GEV-10

10E
10

05.01291.00

GEV-8-45°

8E
8

05.01253.00

GEV-10-45°

10E
10

05.01254.00

Technische Änderungen vorbehalten

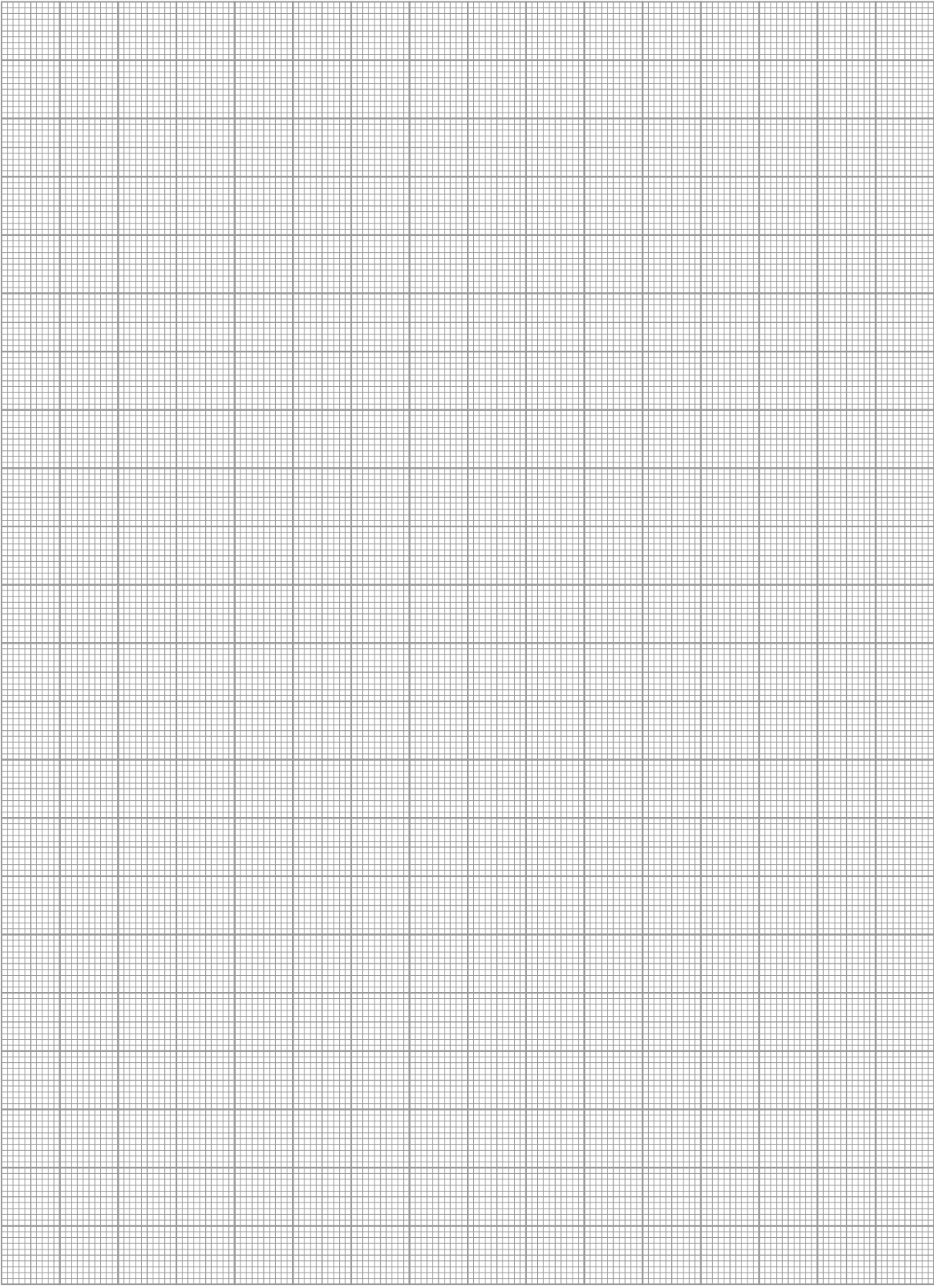

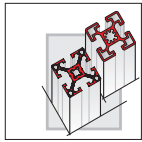



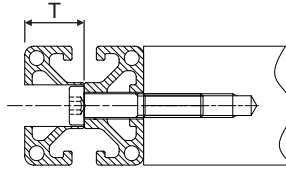
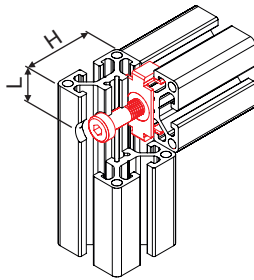







VERBINDERSCHRAUBE AUSSEN
CONNECTOR SCREW EXTERNAL
VIS DE JONCTION EXTERIEUR

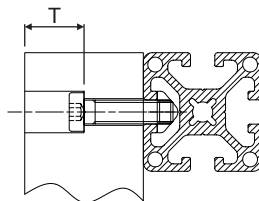
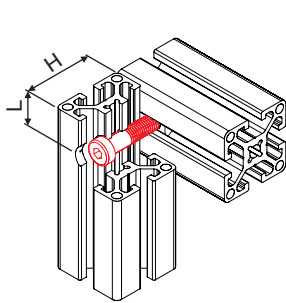

Verdrehsicherung
 Anti-torsion element
 Securite anti-torsion

		H	T	L		DIN 7984	DIN 7984 + 	
VSA 10		20x20	6.5	10	M5 x 25	05.01497.00	05.02279.00	
		40x40	6.5	10	M5 x 50	05.01618.00	05.01560.00	
VSA 14		30x30	10	15	M8 x 40	05.01505.00	05.01137.00	
			40x40	12.5	20	M8 x 50	05.01620.00	05.01561.00
			80x80	52.5	20	M8 x 50	05.01620.00	05.01561.00
VSA 20		45x45	13.5	22.5	M12 x 60	05.01508.00	ISO 4762 05.01562.00	
		60x60	13.5	30	M12 x 80	05.01619.00	ISO 4762	
		90x90	58.5	22.5	M12 x 110	05.01509.00	ISO 4762 05.01368.00	



		H	T	L		DIN 7984			
VSA 10		20x20	6.5	10	M5 x 20	05.01496.00	05.01656.00		
		40x40	6.5	10	M5 x 40	05.01392.00	05.01656.00		
VSA 14		30x30	10	15	M8 x 25	05.01503.00	05.01870.00		
			40x40	12.5	20	M8 x 40	05.01504.00	05.01652.00	
			80x80	52.5	20	M8 x 40	05.01504.00	05.01652.00	
VSA 14		45x45	13.5	22.5	M8 x 30	05.01504.00	05.01064.00	05.01107.00	
		60x60	13.5	30	M8 x 55	05.01649.00	05.01064.00	05.01107.00	
		90x90	58.5	22.5	M8 x 40	05.01505.00	05.01064.00	05.01107.00	

Technische Änderungen vorbehalten

VERBINDERSCHRAUBE INNEN CONNECTOR SCREW INTERNAL VIS DE JONCTION INTERIEUR

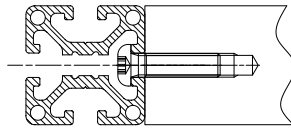
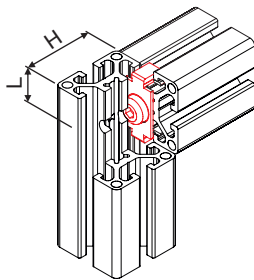

Verdrehsicherung
Anti-torsion element
Securite anti-torsion



Gd-Zn

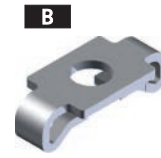

St. verz.



FM-Schraube



ISO 7380

VSI Ø	Profile	Size	Material	SF	Code	Screw	Code
VSI Ø4.3	5	20x20	A	✓	SF 5 x 16	05.01362.00	M5 x 16 05.01365.00
			B	✓	SF 5 x 16	05.02201.10	M5 x 16 05.02201.20
VSI Ø7	8E	30x30		✓			M8 x 25 05.01136.00
		8	A	✓	*SF 8 x 25	05.01363.00	M8 x 25 05.01366.00
			B	✓	*SF 8 x 25	05.02202.10	M8 x 25 05.02202.20
VSI Ø9.5	10	45x45		✓	SF12 x 40	05.01364.00	M12 x 30 05.01367.00
		90x90		✓	SF12 x 40	05.01364.00	M12 x 30 05.01367.00

* Nicht für 40x40EL, 40x80EL, 80x80EL geeignet

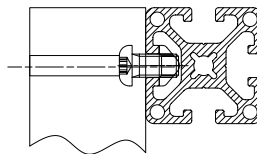
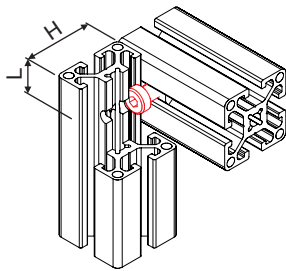

VSI Ø	Profile	Size	L	Screw	Code	Code	Code	
								H
VSI Ø4.3	5	20x20	10	M5 x 8	05.01400.00	05.01656.00		
		40x40	10	M5 x 8	05.01400.00	05.01656.00		
VSI Ø7	8E	30x30	15	M8 x 12	05.01419.00	05.01870.00		
		8	40x40	20	M8 x 16	05.01412.00	05.01652.00	
			80x80	20	M8 x 16	05.01412.00	05.01652.00	
VSI Ø9.5	10	45x45	22.5	M8 x 16	05.01412.00	05.01064.00	05.01107.00	
		60x60	30	M8 x 16	05.01412.00	05.01064.00	05.01107.00	
		90x90	22.5	M8 x 16	05.01412.00	05.01064.00	05.01107.00	

Technische Änderungen vorbehalten

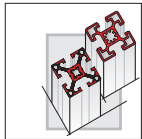

ISO-SCHRAUBEN

ISO-SCREWS

VIS-ISO

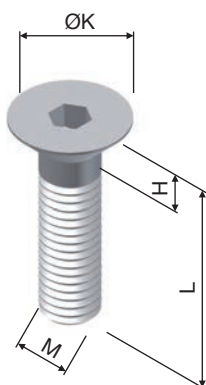

SW3 - M5
SW4 - M6
SW5 - M8

St, vz. - Festigkeitsklasse 8.8
Steel, galvanized - Strength class 8.8
Acier, galvanisé - Classification de résistance 8.8

ISO 10642 (DIN 7991)

M x L **ØK** **H**

M5 x 8	9.5	2.75	05.02357.00
M5 x 10	9.5	2.75	05.02358.00
M5 x 12	9.5	2.75	05.02359.00

M x L **ØK** **H**

M5 x 16	9.5	2.75	05.02342.00
M5 x 20	9.5	2.75	05.02343.00
M5 x 25	9.5	2.75	05.02344.00
M6 x 12	10.5	3.3	05.02345.00
M6 x 16	10.5	3.3	05.01758.00
M6 x 20	10.5	3.3	05.02346.00
M6 x 25	10.5	3.3	05.02347.00
M6 x 30	10.5	3.3	05.02348.00
M8 x 14	14	4.4	05.02349.00
M8 x 16	14	4.4	05.02350.00
M8 x 20	14	4.4	05.02351.00
M8 x 25	14	4.4	05.02352.00
M8 x 30	14	4.4	05.02353.00
M8 x 40	14	4.4	05.02354.00
M8 x 60	14	4.4	05.02355.00
M8 x 80	14	4.4	05.02356.00

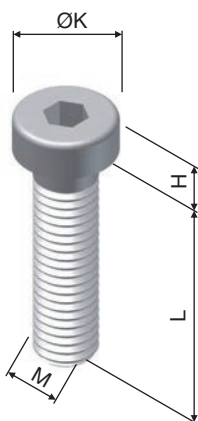

SW3 - M5
SW4 - M6
SW5 - M8

St, vz. - Festigkeitsklasse 8.8
Steel, galvanized - Strength class 8.8
Acier, galvanisé - Classification de résistance 8.8

DIN 7984

M x L **ØK** **H**

M5 x 10	8.5	3.5	05.01494.00
M5 x 16	8.5	3.5	05.01495.00
M5 x 20	8.5	3.5	05.01496.00

M x L **ØK** **H**

M5 x 25	8.5	3.5	05.01497.00	
M6 x 40	10	4	05.01523.00	
M8 x 16	13	5	05.01500.00	
M8 x 20	13	5	05.01502.00	
M8 x 25	13	5	05.01503.00	
M8 x 30	13	5	05.01504.00	
M8 x 40	13	5	05.01505.00	
M8 x 50	13	5	05.01620.00	
M8 x 55	13	5	05.01649.00	
M8 x 60	13	5	05.01506.00	
M8 x 80	13	5	05.01507.00	
M12x 60	18	12	ISO 4762	05.01508.00
M12x 80	18	12	ISO 4762	05.01619.00
M12x110	18	12	ISO 4762	05.01509.00
M16x100	24	16	ISO 4762	05.01621.00

ISO-SCHRAUBEN

ISO-SCREWS

VIS-ISO

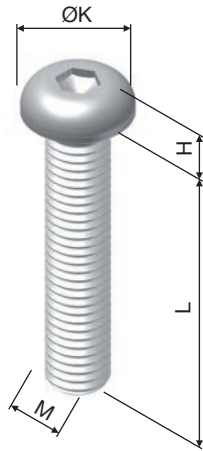

SW3 - M5
SW4 - M6
SW5 - M8

St, vz. - Festigkeitsklasse 10.9
Steel, galvanized - Strength class 10.9
Acier, galvanisé - Classification de résistance 10.9

ISO 7380

M x L	ØK	H	
M5 x 8	9.5	2.75	05.01400.00
M5 x 10	9.5	2.75	05.01401.00
M5 x 12	9.5	2.75	05.01402.00

M x L	ØK	H	
M5 x 16	9.5	2.75	05.01403.00
M5 x 20	9.5	2.75	05.01404.00
M5 x 25	9.5	2.75	05.01405.00
M6 x 12	10.5	3.3	05.01406.00
M6 x 16	10.5	3.3	05.01407.00
M6 x 20	10.5	3.3	05.01408.00
M6 x 25	10.5	3.3	05.01409.00
M6 x 30	10.5	3.3	05.01410.00
M8 x 14	14	4.4	05.01411.00
M8 x 16	14	4.4	05.01412.00
M8 x 20	14	4.4	05.01413.00
M8 x 25	14	4.4	05.01414.00
M8 x 30	14	4.4	05.01415.00
M8 x 40	14	4.4	05.01081.00
M8 x 60	14	4.4	05.01417.00
M8 x 80	14	4.4	05.01418.00

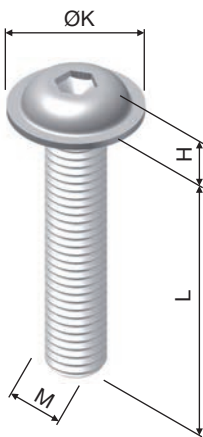

SW3 - M5
SW4 - M6
SW5 - M8

St, vz. - Festigkeitsklasse 10.9
Steel, galvanized - Strength class 10.9
Acier, galvanisé - Classification de résistance 10.9

ähnlich ISO 7380

M x L	ØK	H	
M5 x 8	11.1	2.7	05.01425.00
M5 x 10	11.1	2.7	05.01426.00
M5 x 12	11.1	2.7	05.01427.00

M x L	ØK	H	
M5 x 16	11.1	2.7	05.01428.00
M5 x 20	11.1	2.7	05.01429.00
M5 x 25	11.1	2.7	05.01430.00
M6 x 12	13.3	3.2	05.01431.00
M6 x 16	13.3	3.2	05.01432.00
M6 x 20	13.3	3.2	05.01433.00
M6 x 25	13.3	3.2	05.01434.00
M6 x 30	13.3	3.2	05.01435.00
M8 x 14	17.8	4.3	05.01436.00
M8 x 16	17.8	4.3	05.01437.00
M8 x 20	17.8	4.3	05.01438.00
M8 x 25	17.8	4.3	05.01439.00
M8 x 30	17.8	4.3	05.01082.00
M8 x 40	17.8	4.3	05.01441.00
M8 x 60	17.8	4.3	05.01442.00
M8 x 80	17.8	4.3	05.01443.00

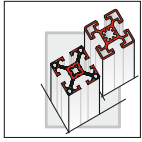

VERBINDERLASCHEN CONNECTING STRAP PLAQUES



Erforderliche Verbinder:
Connectors required:
Fixations recommandées :

- A** Hammerschraube M8x15 05.01050.00
- B** Hammerschraube M8x20 05.01051.00
- C** ISO 10642 M6x12 05.02345.00
- D** ISO 10642 M6x16 05.01758.00
- E** ISO 10642 M8x16 05.02350.00
- F** FM-Schraube SF8x25 05.01124.00

30x60x6

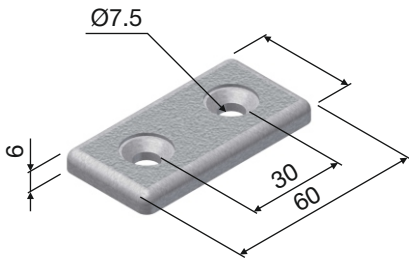

GD-Zn

C D 05.02073.00

40x80x6

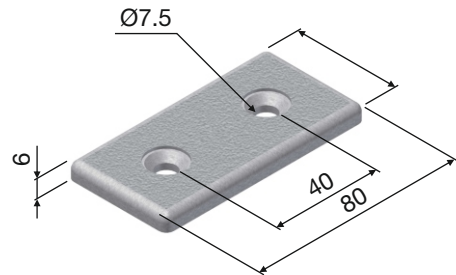

GD-Zn

C D 05.02033.00

SZ-Winkel 100x100x6



Bracket 100x100x6 · Equerre 100x100x6

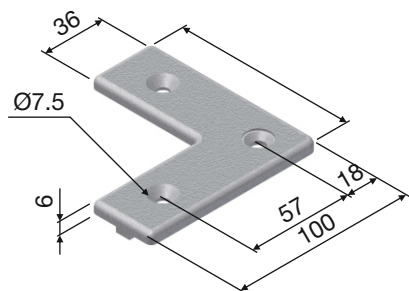

GD-Zn

mit Zentrierfahnen
with centering lugs
avec ergots de centrage **D B** 05.02032.00

45x90x6

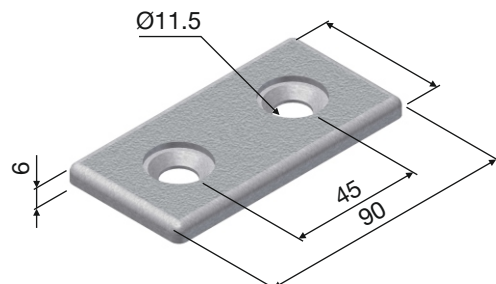



GD-Zn

E B 05.02074.00

Technische Änderungen vorbehalten

VERBINDERLASCHEN CONNECTING STRAP PLAQUES



40x80x4 **45x90x4**  

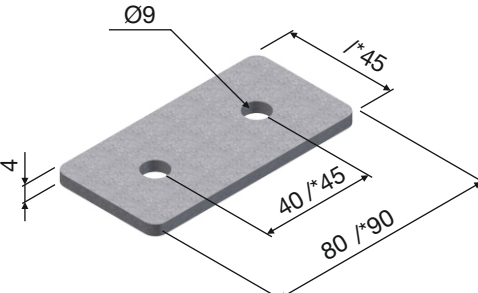

St, vz 4 mm

40x80x4	B	05.01570.00
*45x90x4	B	05.01571.00





Knotenplatte 80, 90  

Plate 80, 90 · Plaque de renfort 80, 90

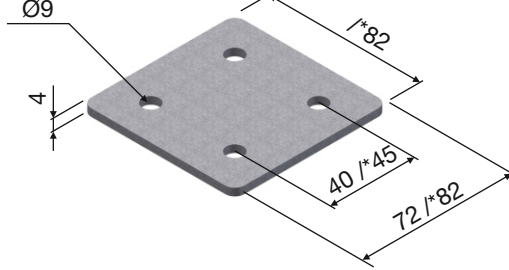

St, vz 4 mm

80x80x4	B	05.01568.00
*90x90x4	B	05.01569.00

Winkel 40 

Bracket 40 · Equer
DIN74 -

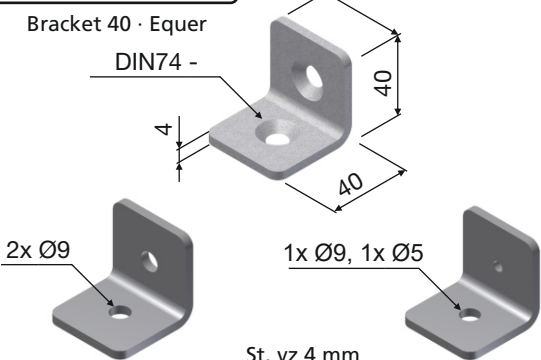

2x Ø9 1x Ø9, 1x Ø5

St, vz 4 mm

E	05.01572.00
----------	-------------

St, vz 4 mm St, vz 4 mm

05.01809.00	A	A	05.01808.00
-------------	----------	----------	-------------





Winkelplatte 90°  

Plate angle 90° · Plaque de equer 90°

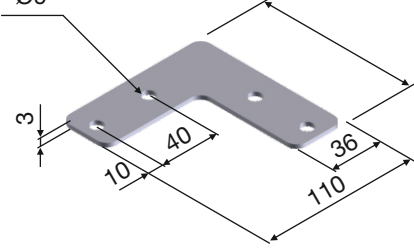

St, vz 3 mm

B	05.01160.00
----------	-------------

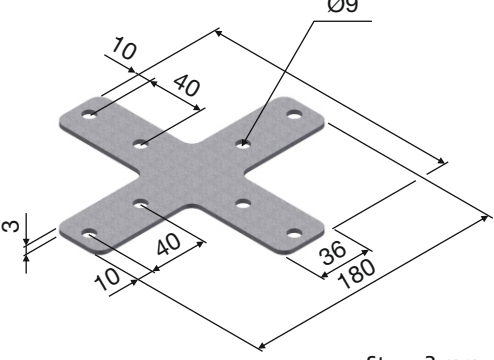

Kreuzplatte  

Cross plate · Croix-plaque



St, vz 3 mm

B	05.01162.00
----------	-------------

T-Platte  

T-plate · T-plaque

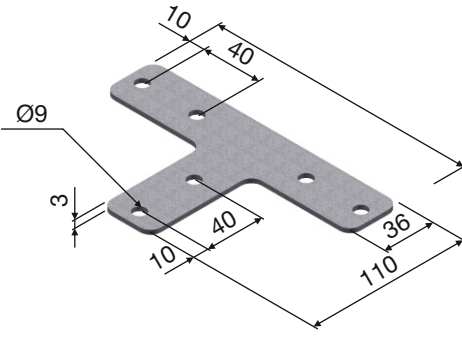

St, vz 3 mm

B	05.01161.00
----------	-------------



Technische Änderungen vorbehalten

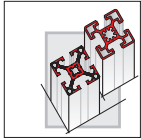

HAMMERSCHRAUBE

T-BOLT

VIS DE TOUR

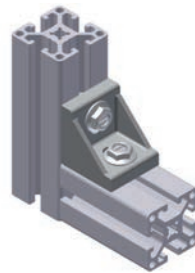
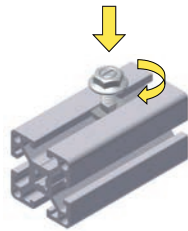

Innovative Vorteile

- Für nachträgliche Befestigungen in Alu-Profilen
- Für leichte bis mittlere Belastungen
- Leichte und schnelle Montage
- Kostengünstige Verbindung

Innovative advantages

- For later fastening to aluminium profiles
- For light to medium loads
- Quick and easy to fit
- Economic connector

Atouts novateurs

- Pour un montage ultérieur dans le profilé
- Pour charges légères et moyennes
- Montage aisé et rapide par 1/4 de tour
- Connexion bonne marché

Ausführung

Stahl, verzinkt
Festigkeitsklasse 8.8

Design

Galvanized steel
Strength class 8.8

Matière

Acier zingué
Classe de résistance 8.8

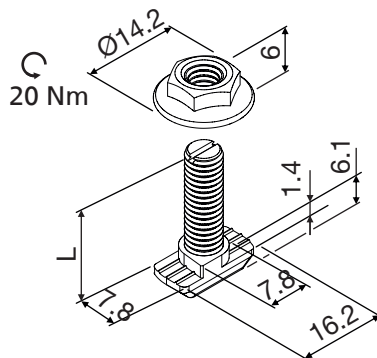

Profile	Size
8E	M6x16
8	M6x20
	M6x25

St, vz

VA

05.02140.00	
05.02141.00	05.02141.50
05.02142.00	05.02142.50

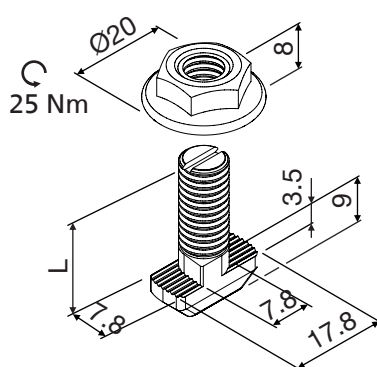

Profile	Size
8	M8x15
10	M8x20
	M8x25
	M8x30
	M8x40
	M8x50
	M8x60
	M8x80

St, vz

VA 10

05.01050.00	
05.01051.00	05.01051.50 *
05.01052.00	05.01052.50 *
05.01053.00	05.01053.50 *
05.01054.00	*Nur für Nut 10
05.01055.00	
05.01056.00	
05.01057.00	



Abdeckkappe für Flanschmutter M8 - PE
Cap for flange nut M8 - PE
Cache pour écrou M8 - PE

05.01059.00

Flanschmutter M6 - St, vz.
Flange nut M6 - steel, galvanized
Ecrou M6 - acier, galvanisé

05.02237.00

Flanschmutter M8 - St, vz.
Flange nut M8 - steel, galvanized
Ecrou M8 - acier, galvanisé

05.02238.00

HAMMERMUTTER

T-NUT

ECROUS 1/4 DE TOUR



Innovative Vorteile

- Universell einsetzbarer Verbinder
- Einlegbar an beliebiger Stelle in Profilmutter
- Geriffelte Oberfläche zum Durchbrechen der Eloxalschicht

Innovative advantages

- Connector for universal applications
- Can be inserted at any point in profile groove
- Ribbed surface to break through the anodized layer

Atouts novateurs

- Éléments de jonction universels
- Positionnables quel que soit l'emplacement dans la rainure
- Assemblage conducteur

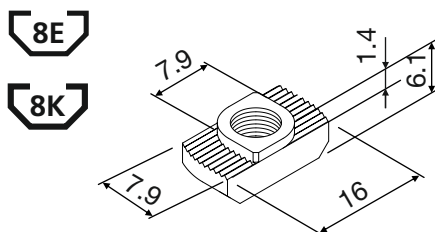
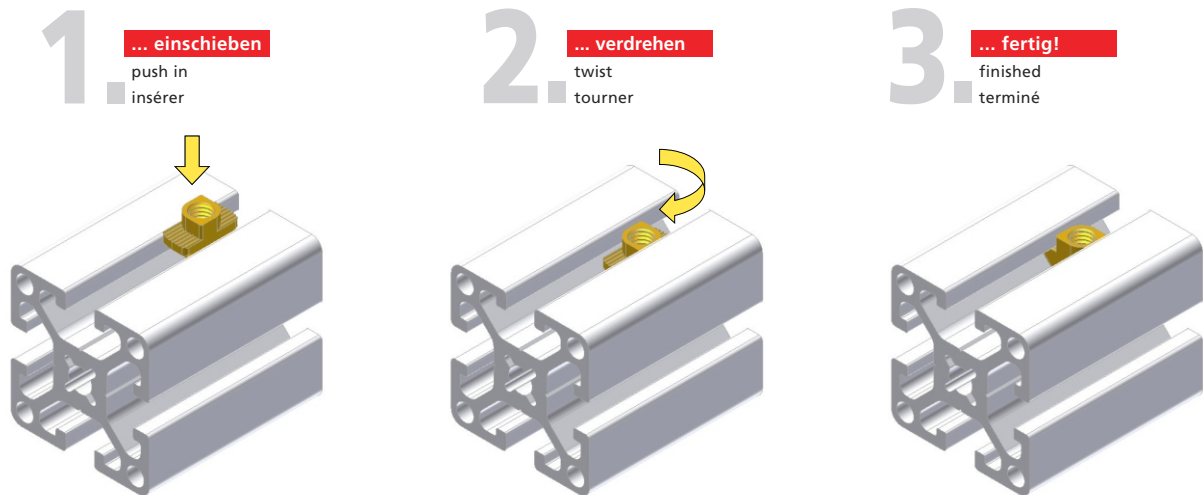

		St, vz	VA
M4	4 Nm	05.01102.00	
M5	6 Nm	05.01103.00	
M6	10 Nm	05.01104.00	05.01104.50

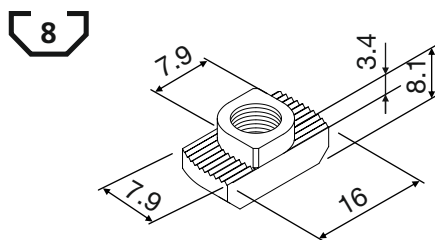

M4	4 Nm	05.01660.00
M5	6 Nm	05.01661.00
M6	10 Nm	05.01662.00

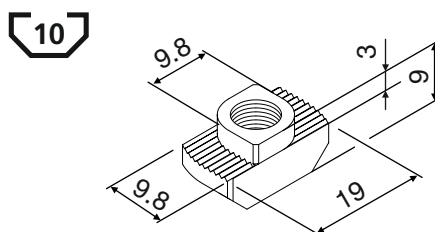

M4	4 Nm	05.01138.00	
M5	6 Nm	05.01105.00	
M6	10 Nm	05.01106.00	05.01106.50
M8	25 Nm	05.01107.00	05.01107.50

Technische Änderungen vorbehalten

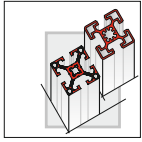

VERBINDER CONNECTION JONCTION



Gewindeplättchen 5

- Für leichte Belastungen
- Stirnseitig in Profil einlegbar

Ausführung: Stahl vergütet
M4 = blau verzinkt
M5 = schwarz verzinkt

Threaded plate 5

- For light loads
- Insertable in profile on front side

Design: galvanized steel
M4 = blue galvanized
M5 = black galvanized

Ecrou plat 5

- Pour charges légères
- Insérable en bout de profilé

Matière: Acier zingué
M4 = bleu zingué
M5 = noir zingué

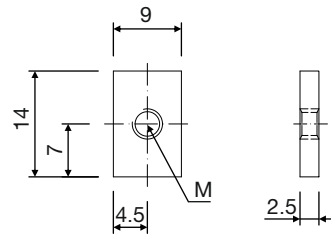
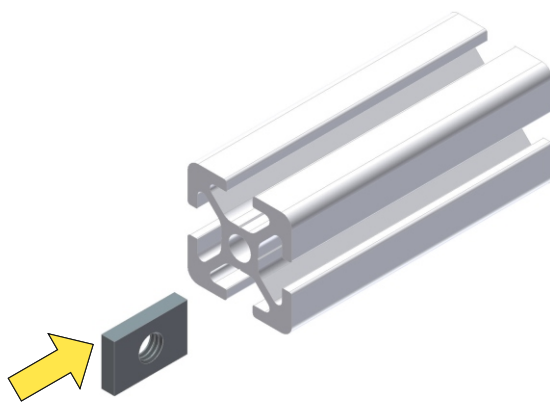

		St, vz.	
	M4	3 Nm	05.01842.00
	M5	3 Nm	05.01843.00

Einschiebemutter 5

- Für leichte Belastungen
- Stirnseitig in das Profil einlegbar

Ausführung: Stahl vergütet
M4 = blau verzinkt
M5 = schwarz verzinkt

Insert nut 5

- For light loads
- Insertable in profile on front side

Design: galvanized steel
M4 = blue galvanized
M5 = black galvanized

Ecrou demi-lune 5

- Pour charges légères
- Insérable en bout de profilé

Matière: Acier zingué
M4 = bleu zingué
M5 = noir zingué

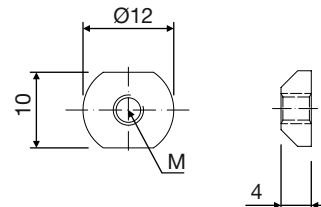
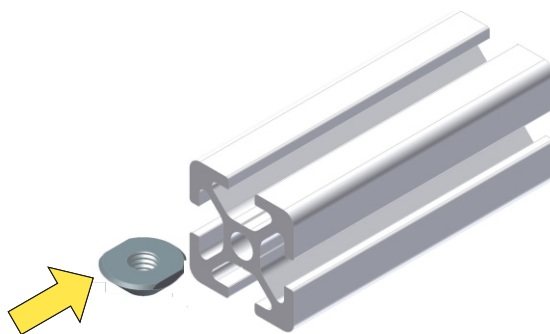

		St, vz.	
	M4	3 Nm	05.01840.00
	M5	3 Nm	05.01841.00

NUTENSTEIN 20, 30
SLIDING BLOCK 20, 30
COULISSEAU 20, 30



Nutenstein halbrund

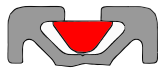
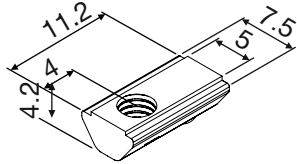

		St, vz	
5	M4	3 Nm	05.01655.00
	M5	4.5 Nm	05.01656.00

Nutenstein halbrund

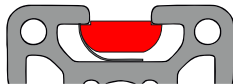
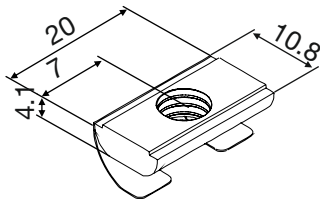

		St, vz	
8K	M4	3 Nm	05.02423.00
	M5	6 Nm	05.02424.00
	M6	12 Nm	05.02425.00
	M8	23 Nm	05.02426.00

Nutenstein halbrund

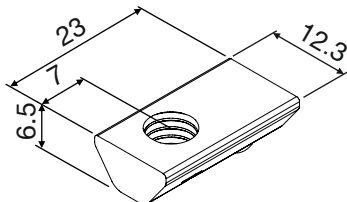

		St, vz	
8E	M5	6 Nm	05.01872.00
	M6	12 Nm	05.01871.00
	M8	23 Nm	05.01870.00

Nicht geeignet für Nut 8K

Not suitable for groove 8K

Ne convient pas pour la rainure 8K



Nutenstein T-Form

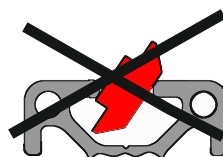
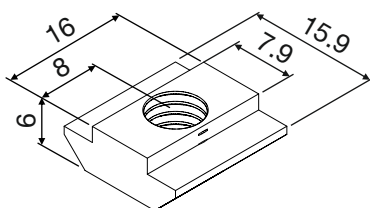

		St, vz	
8E	M4	4 Nm	05.01472.10
	M5	8 Nm	05.01471.10
	M6	10 Nm	05.01470.10
	M8	30 Nm	05.01469.10

Technische Änderungen vorbehalten

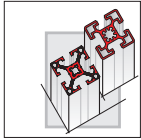

NUTENSTEIN 40 SLIDING BLOCK 40 COULISSEAU 40



Nutenstein halbrund

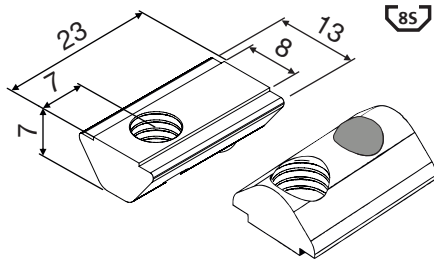

	St, vz	VA
M4	4 Nm 05.01063.00	
M5	8 Nm 05.01654.00	05.01654.50
M6	14 Nm 05.01653.00	05.01653.50
M8	25 Nm 05.01652.00	05.01652.50



Nur stirnseitig einsetzbar
Insertable on front side
Insérable en bout de profilé

Nutenstein halbrund mit Gewindestift

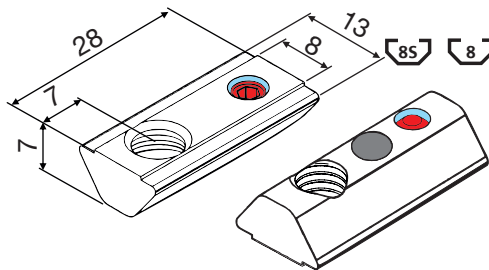

	St, vz
M5	8 Nm 05.02001.00
M6	14 Nm 05.02002.00
M8	25 Nm 05.02003.00



Nur stirnseitig einsetzbar
Insertable on front side
Insérable en bout de profilé

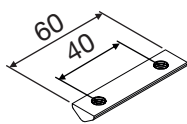

60 mm - M8

05.01093.00

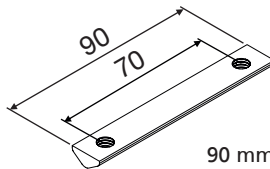

90 mm - M8

05.01094.00

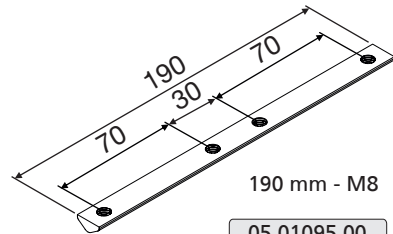

190 mm - M8

05.01095.00

Nutenstein T-Form - schwer

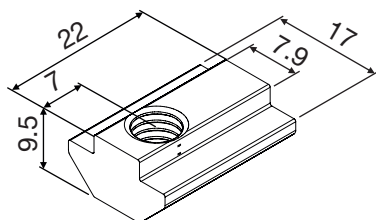

	St, vz	VA
M5	8 Nm 05.01087.00	
M6	14 Nm 05.01088.00	
M8	34 Nm 05.01089.00	05.01089.50

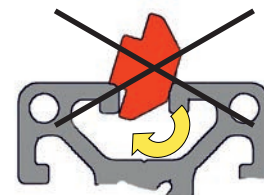

Technische Änderungen vorbehalten

NUTENSTEIN 45

SLIDING BLOCK 45

COULISSEAU 45



Nutenstein halbrund

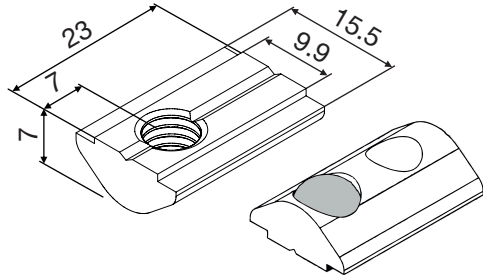

		⌚	St, vz	VA
10	M5	10 Nm	05.01066.00	05.01066.50
	M6	16 Nm	05.01065.00	05.01065.50
	M8	28 Nm	05.01064.00	05.01064.50

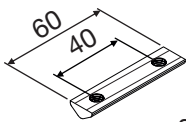
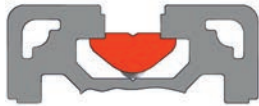

60mm - M8

05.01096.00

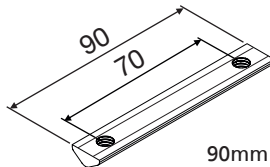

90mm - M8

05.01097.00

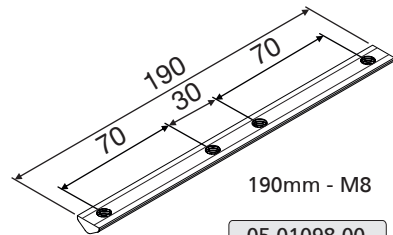

190mm - M8

05.01098.00

Nutenstein T-Form

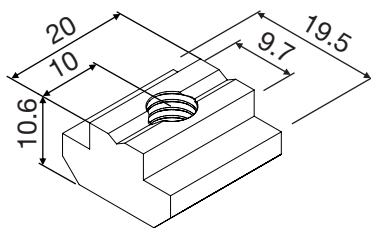

		⌚	St, vz	VA
10	M5	12 Nm	05.01069.00	
	M6	21 Nm	05.01068.00	
	M8	42 Nm	05.01067.00	05.01067.50

Feder • Spring • Ressort

05.01080.00

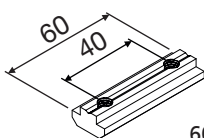
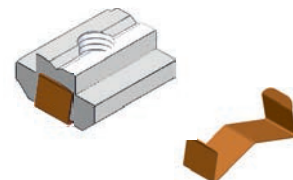

60 mm - M8

05.01099.00

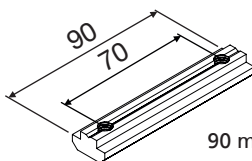

90 mm - M8

05.01100.00

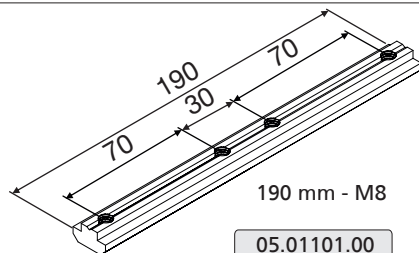

190 mm - M8

05.01101.00

Technische Änderungen vorbehalten



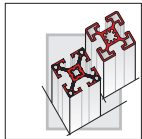

VERBINDER CONNECTOR JONCTION



Einschiebemutter

- Hoher Traganteil der Auflagefläche
- Durch Feder in der Nut fixiert
- Universelles Element für 3 Nut-Typen
- Stirnseitig in Profil einziehbar

Ausführung
Stahl, verzinkt

Insert nut

- High bearing section of resting surface
- Fastened in slot by spring
- Universal element for 3 slot versions
- Push into profile from front

Design
Steel, galvanized

Ecrou plat

- Grande surface d'appui
- Fixation par ressort dans la rainure
- Élément universel pour 3 types de rainures
- Insérable en bout de profilé

Matière
Acier zingué

Einschiebemutter

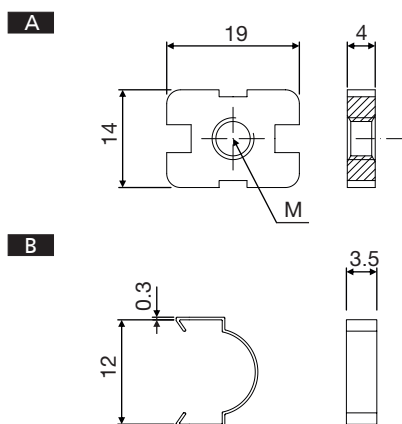

		⌚	A + B	
8K	8E	8	10	
M4	3 Nm	05.01885.00	05.01885.10	
M5	5 Nm	05.01886.00	05.01886.10	
M6	10 Nm	05.01887.00	05.01887.10	
M8	15 Nm	05.01888.00	05.01888.10	
Feder • Spring • Ressort			05.01889.00	

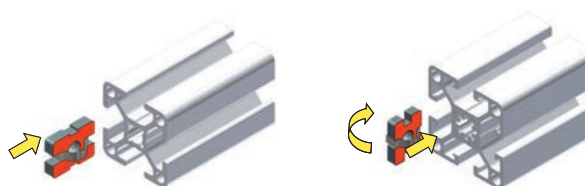

Nutenstein flach

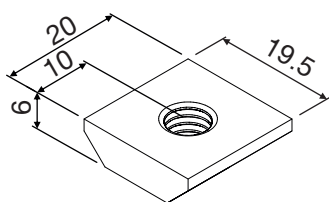

		⌚	St, vz
8	10	M4	5 Nm 05.01221.00
		M5	10 Nm 05.01072.00
		M6	14 Nm 05.01071.00
		M8	26 Nm 05.01070.00
Feder • Spring • Ressort			05.01080.00

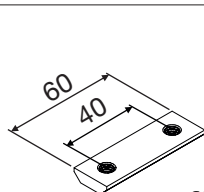
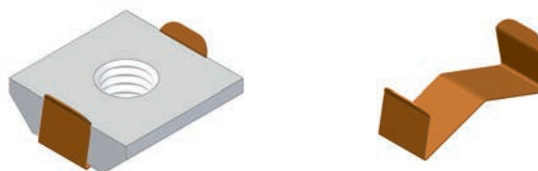

60 mm - M8

05.01090.00

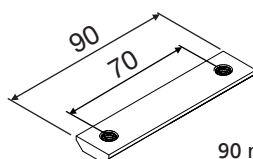

90 mm - M8

05.01091.00

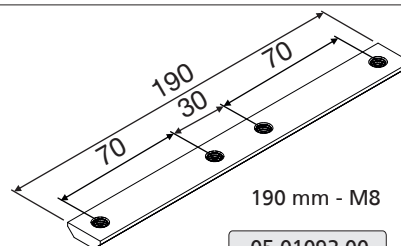

190 mm - M8

05.01092.00

Technische Änderungen vorbehalten

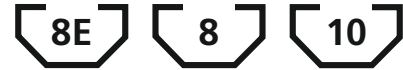

Gewindehülse SF

- Für alle Profile mit 10 mm Kernloch
- Kein Gewindeschneiden
- Die selbstfurchende Gewindeform "FM-Spezial" erleichtert das Eindrehen
- Selbstzentrierend durch Zentrierschaft
- Einfache Montage durch Inbusschlüssel
- Innengewinde metrisch

Threaded sleeve SF

- For all profiles with a central bore of 10 mm
- No thread cutting
- Self-tapping thread "FM-Spezial" makes it easier to screw in
- Self-centring with centring shaft
- Allen key for easy fitting
- Metric inner thread

Douilles-insert autotaraudeuses centres

- Pour tous les profilés avec un trou central de 10 mm
- Taraudage superflu
- Vissage facile par vis autotaraudeuse à filetage spiralé "FM-Spezial" et enduction GleitMo
- Autocentrage par pion axial
- Montage aisé par clé 6 pans
- Taraudage métrique

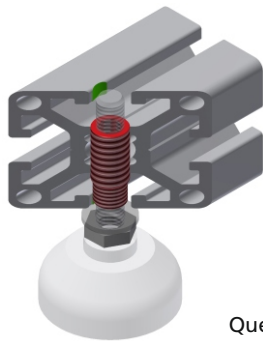

Quer oder Stirnseitig einsetzbar

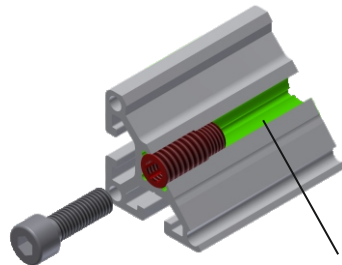

Kernloch Ø10

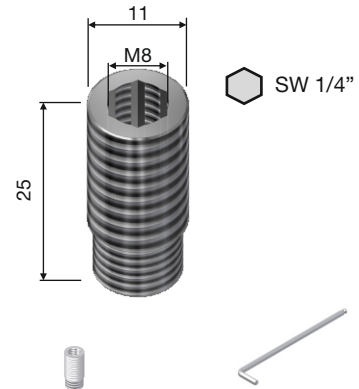

05.01369.00

05.01040.00

Gewindeeinsätze

- Kein Gewindeschneiden
- Außengewinde metrisch
- Stahl, einsatzgehärtet, verzinkt

Thread inserts

- No thread cutting
- Metric outer thread
- Steel, case hardened, galvanized

Inserts taraudes

- Taraudage superflu
- Taraudage métrique
- Acier zingué

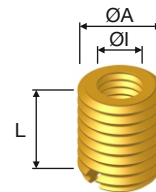
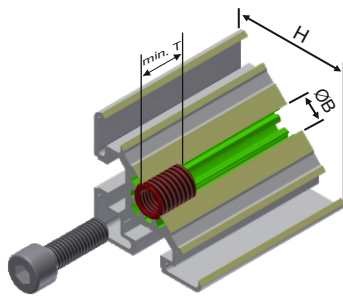

H	ØA	ØI	L	ØB	min.T		
30	8	M5	10	7.5	13	05.01370.00	05.01374.00
40	10	M6	14	9.2	17	05.01371.00	05.01375.00
40 45	12	M8	15	11.2	19	05.01372.00	05.01376.00
45	14	M10	18	13.2	22	05.01373.00	05.01377.00
45	16	M12	22	15.2	27	05.01398.00	05.01399.00

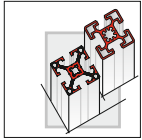

VERBINDER CONNECTION JUNCTION

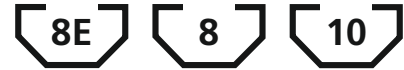

Gewindehülse

Threaded sleeve

Douilles-insert canele

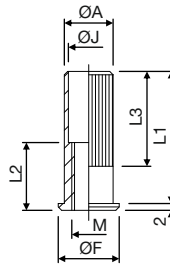
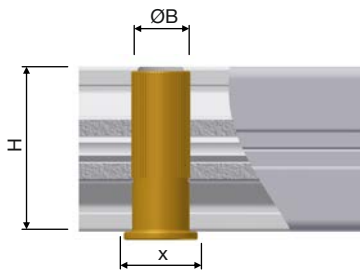

* ohne Bund
without collar
sans epaulement

**durchgehend
continuous
traversant

H	M	ØB	ØA	ØJ	ØF	L1	L2	L3	
30	M8	11	11.3	9	15	29	15	16	05.01421.00
40	M10	14	14.4	12	18	39	20	26	05.01422.00
40	M12	14	14.4	13	18	39	20	26	05.01423.00
45	M12	17	17.4	13	20	44	20	32	05.01424.00
45	M16	20	20.4	17	-*	54	32	-**	05.01420.00

Verdrehsicherung

Non-twisting

Ecrou antirotation

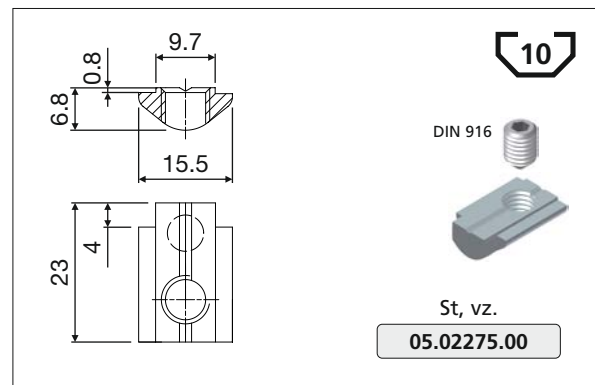
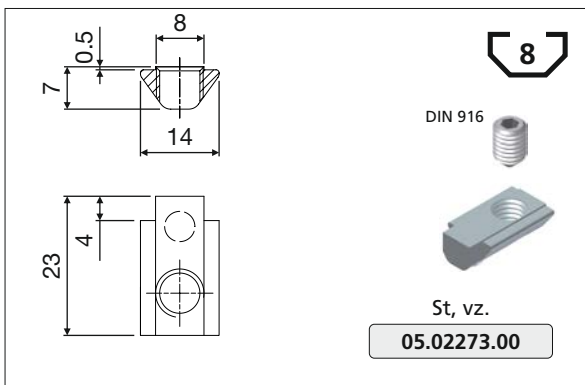
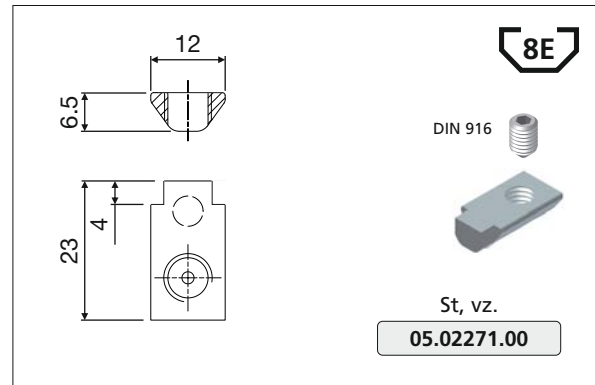
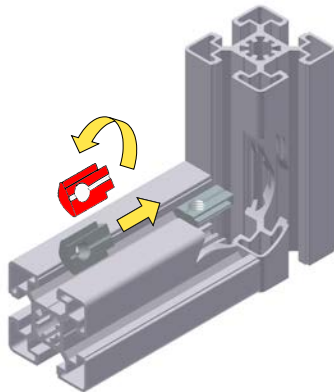

Technische Änderungen vorbehalten

WINKEL UND GELENKE

BRACKETS AND JOINTS

EQUERRES ET ARTICULATIONS



■ 4.02



■ 4.02



■ 4.03



■ 4.03



■ 4.03



■ 4.04



■ 4.04



■ 4.04

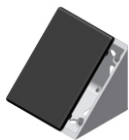

■ 4.05

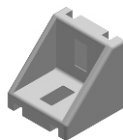

■ 4.06



■ 4.06



■ 4.06



■ 4.07



■ 4.07



■ 4.08

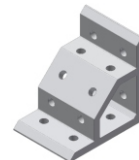

■ 4.08

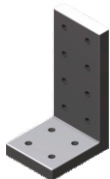

■ 4.09



■ 4.10



■ 4.11

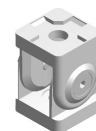

■ 4.12



■ 4.12



■ 4.13

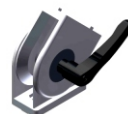

■ 4.14

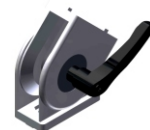

■ 4.14

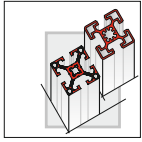

WINKEL 20, 30 BRACKETS 20, 30 EQUERRES 20, 30



18x18x18 A

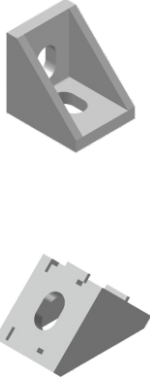

20x20x17 B

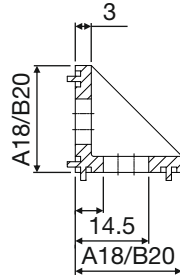
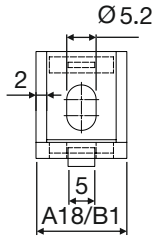

GD-Al	A	05.01222.00
GD-Zn	B	05.01256.00
GD-Al + 2x	A	05.01222.05
GD-Zn + 2x	B	05.01256.05
PA6	A	05.01285.00
PA6	B	05.01145.00
GD-Al + 2x	A	05.01222.10
GD-Zn + 2x	B	05.01256.10

20x28x28

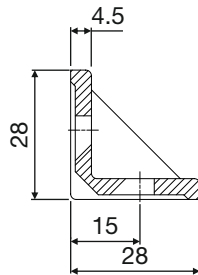
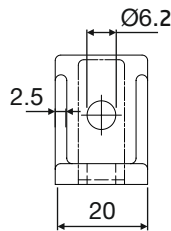
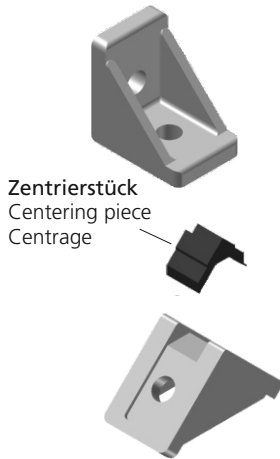

GD-Zn		05.01255.00
GD-Zn + 2x	5	05.01255.20
GD-Zn + 2x	8E	05.01255.05
GD-Zn + 2x	8	05.01255.05
GD-Zn + 2x	8E 10	05.01255.10
GD-Zn + 2x	10	05.01255.15
GD-Zn + 2x	6	05.01255.25

20x28x28 mit Zentrierfahnen

With centering lugs · Avec ergots de centrage

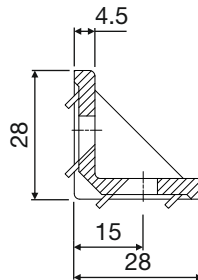
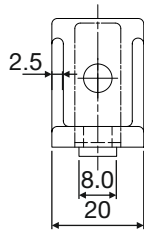
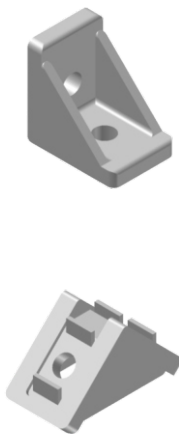

GD-Zn		05.01257.00
GD-Zn + 2x	8E	05.01257.05
GD-Zn + 2x	8K	05.01257.10

Technische Änderungen vorbehalten

WINKEL 30, 40
BRACKETS 30, 40
EQUERRES 30, 40



28x27x27

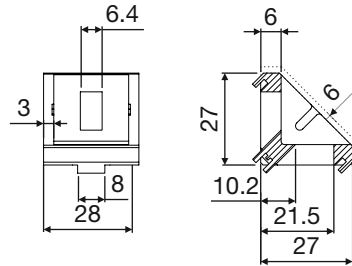

05.01108.00



05.01109.00



05.01108.05



R 28x38

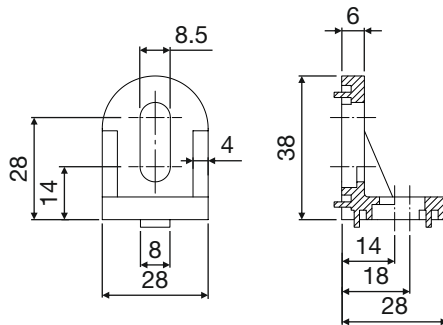

05.01129.00



05.01129.05

R 40x43

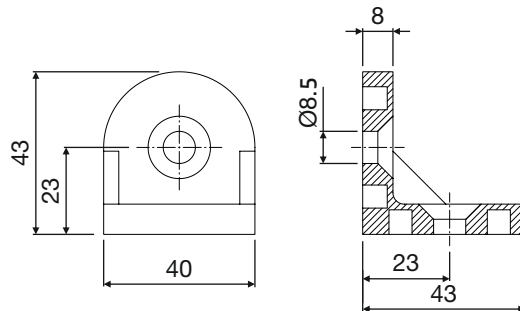

05.01085.00



05.01085.05



05.01085.10

Technische Änderungen vorbehalten

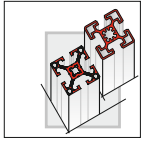

WINKEL 40
BRACKETS 40
EQUERRES 40



38x40x40

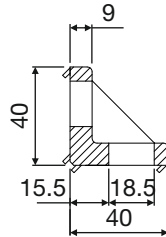
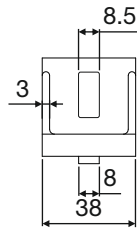

05.01250.00



05.01250.05

40x55x55

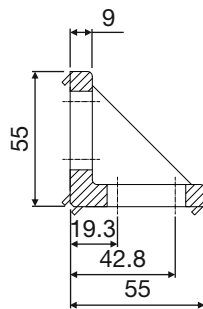
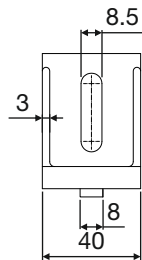

05.01251.00



05.01251.05

40x80x80

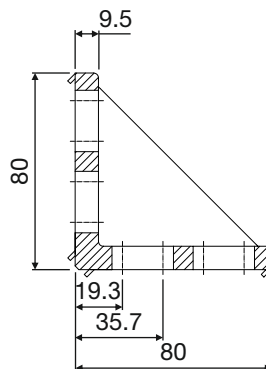
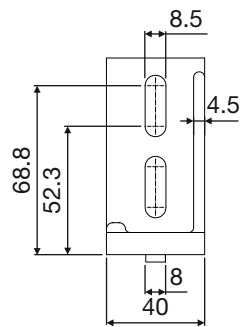

05.01252.00



05.01252.05

Technische Änderungen vorbehalten

WINKEL 40, 80
BRACKETS 40, 80
EQUERRES 40, 80



40x40x40

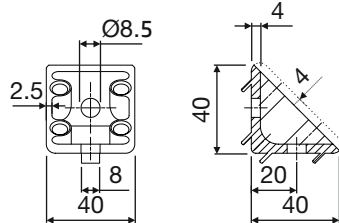

05.01980.00



05.01985.00



05.01980.05

40x80x80

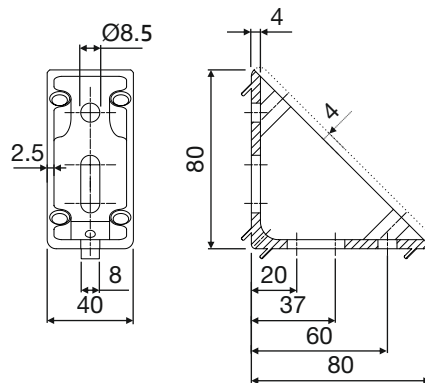
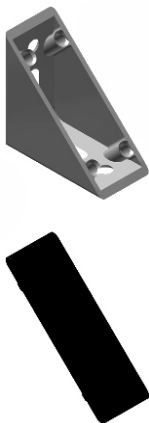

05.01981.00



05.01986.00



05.01981.05

80x80x80

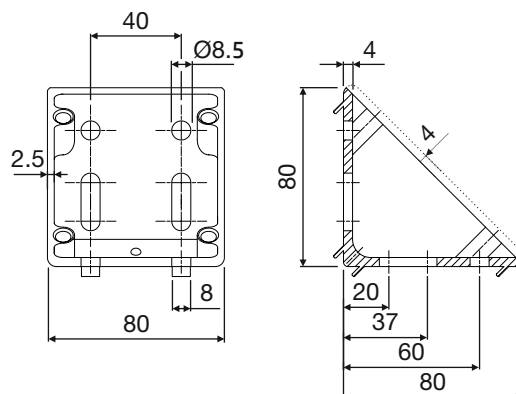
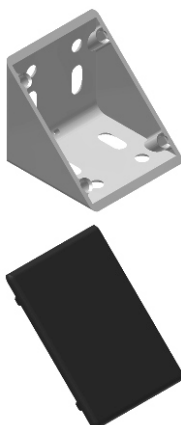

05.01982.00



05.01987.00



05.01982.05

Technische Änderungen vorbehalten

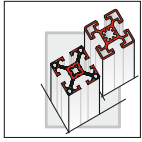

WINKEL 45
BRACKETS 45
EQUERRES 45



43x42x42

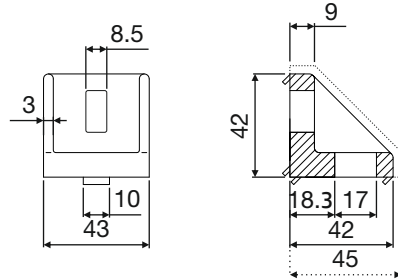

05.01144.00



05.01144.05



05.01140.00



05.01144.10

42x88x88

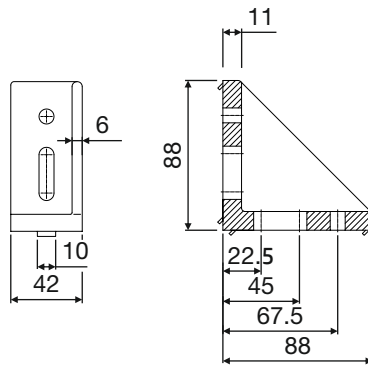

05.01152.00



05.01152.05

42x88x88 2-stegig

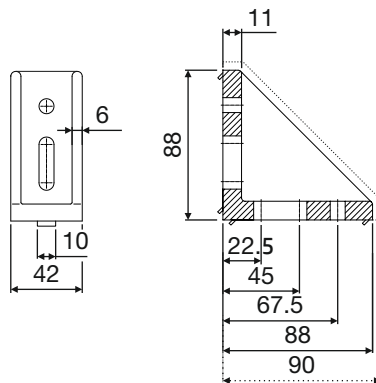
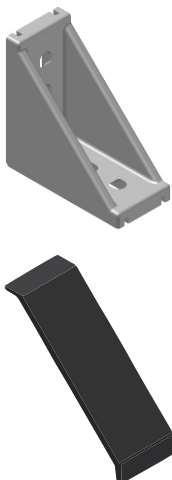

05.01142.00



05.01142.05



05.01143.00



05.01142.10

Technische Änderungen vorbehalten

WINKEL 45
BRACKETS 45
EQUERRES 45



57x57x57

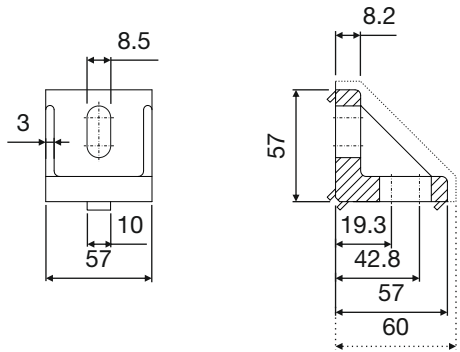
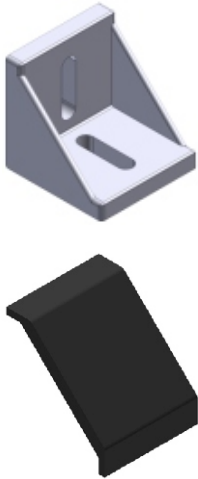

05.01148.00



05.01148.05



05.01141.00



05.01148.10

88x88x88

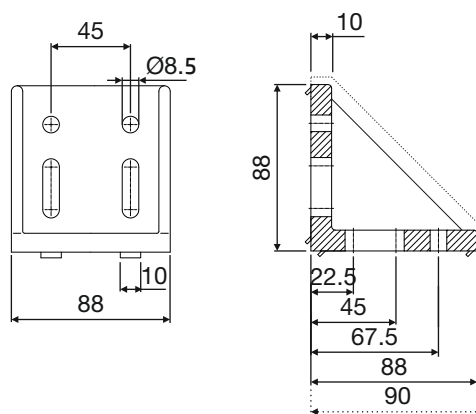
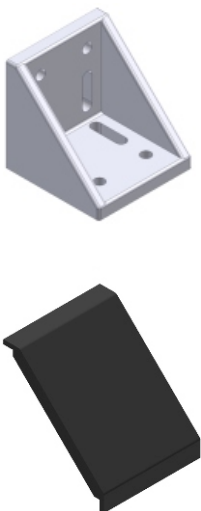

05.01153.00



05.01153.05



05.01139.00



05.01153.10

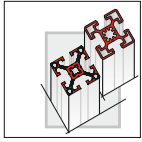

ALUWINKEL
ALUBRACKET
EQUERRE DE ALU



35x35

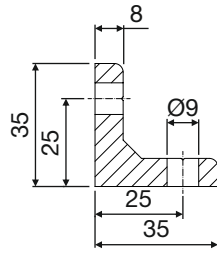
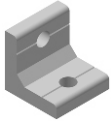

A

05.01157.00

B

05.01158.00

C

05.01159.00



A

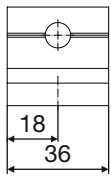

B

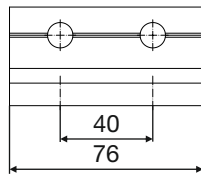

C

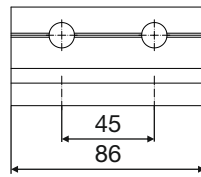

98x98

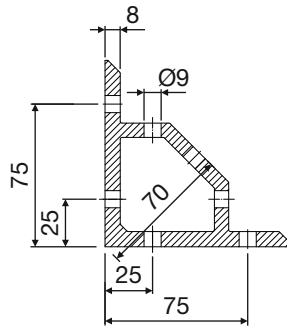
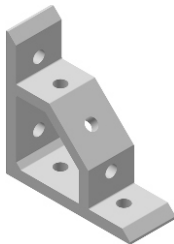

A

05.01155.00

B

05.01156.00

C

05.01239.00

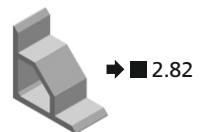

A

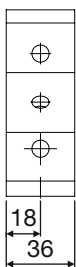

B

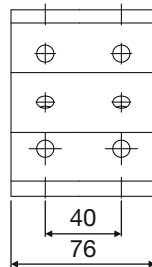

C

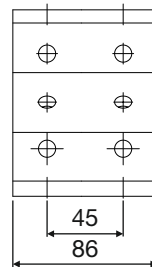

Ermittlung der Strebenlänge:

Determination of the prop length:

Détermination longueur de jambe :

$$A = \sqrt{2W^2} - 140$$

$$B = \sqrt{2W^2} - 148$$

$$C = \sqrt{2W^2} - 148$$

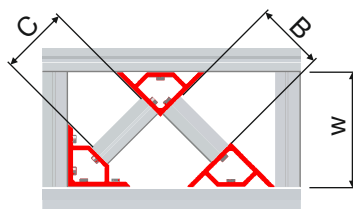
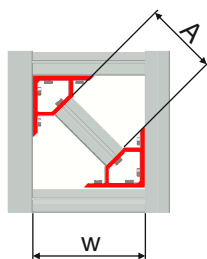

Technische Änderungen vorbehalten

ANSCHRAUBWINKEL / WINKELKONSOLE
SCREW-ON ANGLE / ANGLE CONSOLE
CONSOLE D'ANGLE



Winkelkonsole 80x180

Angle console · Console d'angle

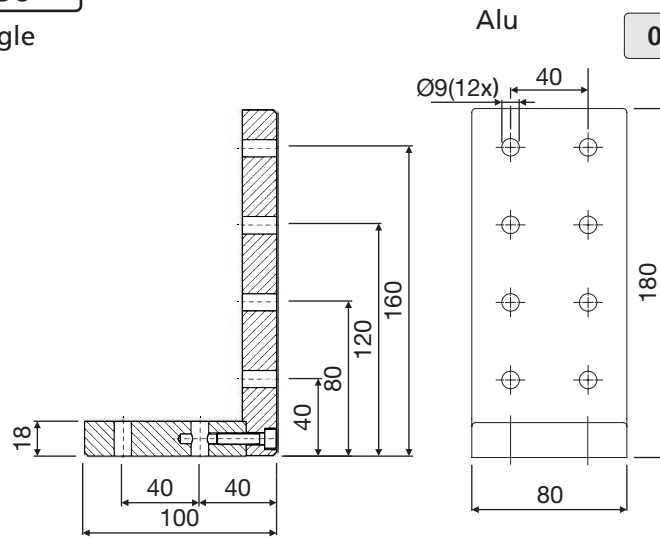
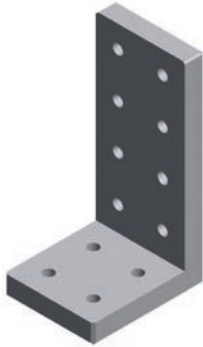

Alu

05.02252.10

Anschraubwinkel 58x40

Screw-on angle · Angle de vissage

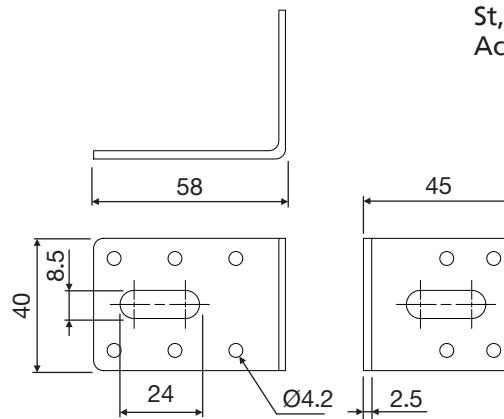
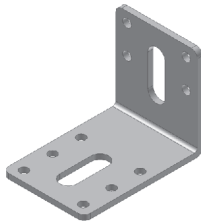

St, vz.
 St, galv.
 Ac, zing.

05.01163.00

Anschraubwinkel 100x40

Screw-on angle · Angle de vissage

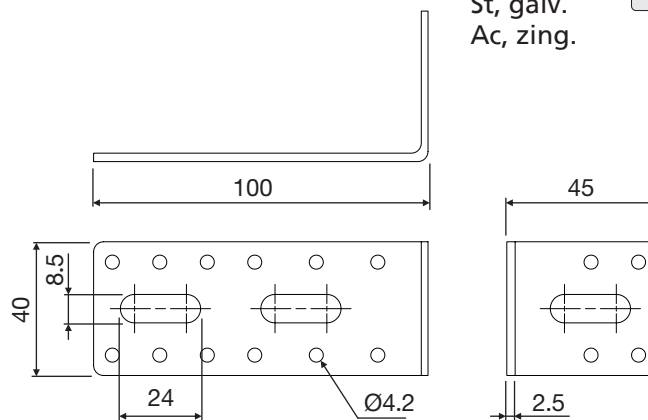
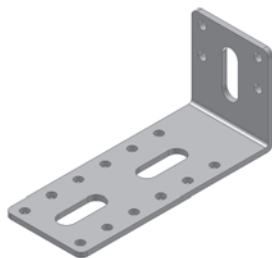

St, vz.
 St, galv.
 Ac, zing.

05.01164.00



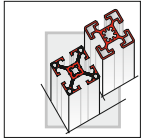

WINKELVERBINDERELEMENT-2

ANGLE ELEMENT-2

ELEMENTS D'ANGLE-2



8 Beidseitige Anwendung möglich
 Reciprocal application possible
 Application mutuelle possible

10 Nur einseitige Anwendung möglich
 Only one-sided application possible
 Application seulement unilatérale possible

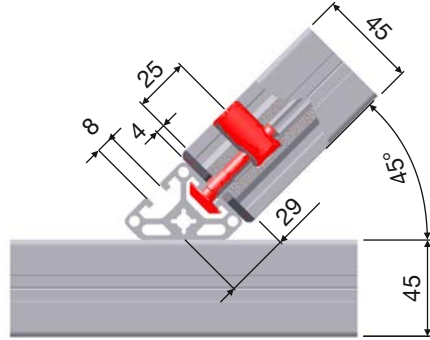
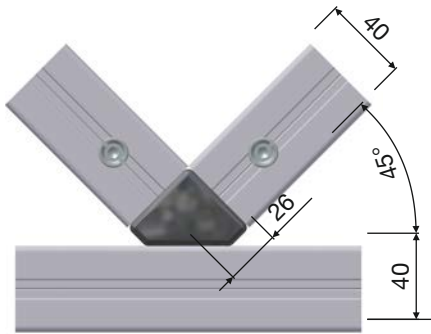

8/40-2

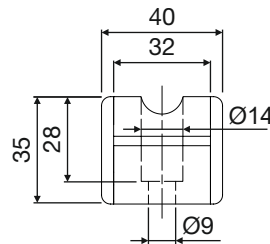

8 05.01574.00

- 1x
- 2x
- 1x
- 1x

8/80-2

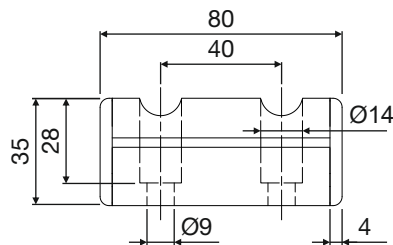
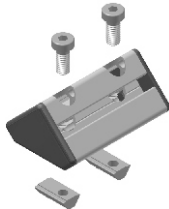

8 05.01575.00

- 1x
- 2x
- 2x
- 2x

10/45-2

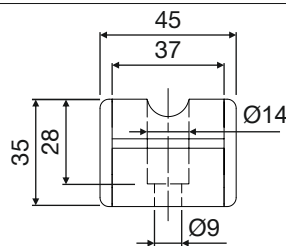

10 05.01576.00

- 1x
- 2x
- 1x
- 1x

10/90-2

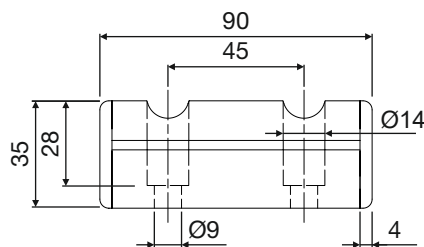
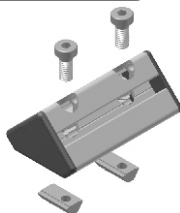

10 05.01577.00

- 1x
- 2x
- 2x
- 2x

Technische Änderungen vorbehalten

WINKELVERBINDERELEMENT-1

ANGLE ELEMENT-1

ELEMENTS D'ANGLE-1

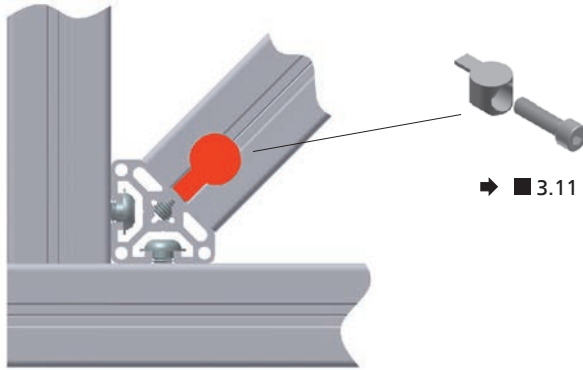

Die Querstrebe wird durch zwei UNI-Verbinder (Zentrierfahnen abgebrochen) befestigt.

The cross-struts are fastened in place by two UNI connectors (centering lugs broken off).

La traverse est fixée par deux fixations UNI.

8/40-1

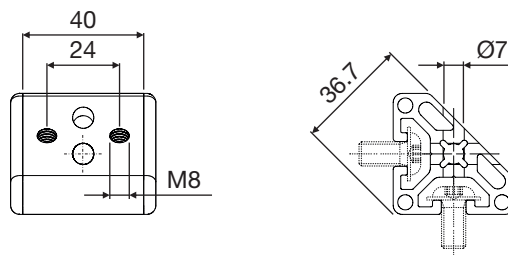

05.01578.00

- 1x
- 2x
- 2x
- 2x

8/80-1

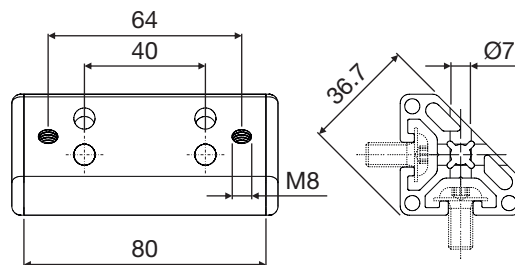
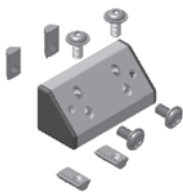

05.01579.00

- 1x
- 2x
- 4x
- 4x

Schwenkwinkel 180°

Pivot angle 180° · Angle de pivotement 180° vissage

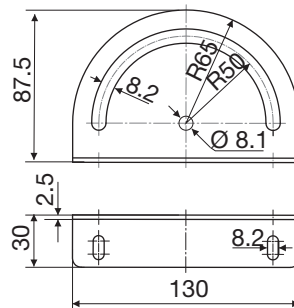

05.01258.00

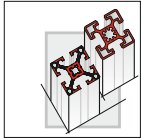

GELENKE JOINTS ARTICULATIONS

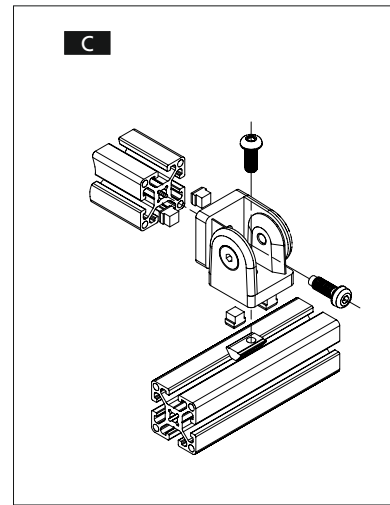
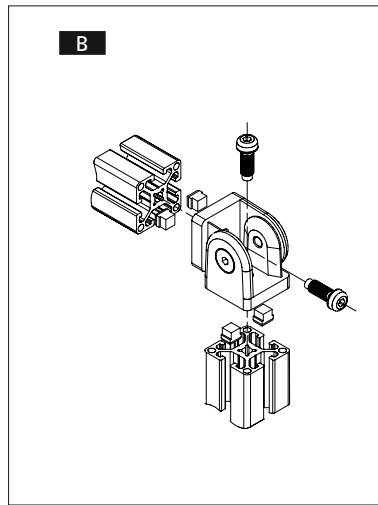
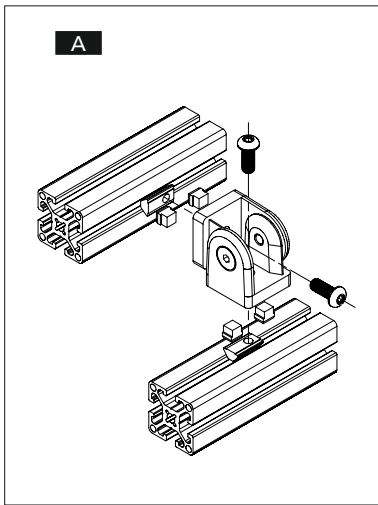

20x20

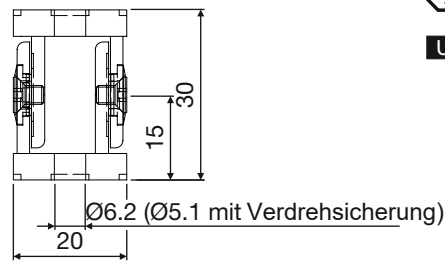
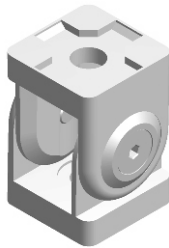

- GD-AI, RAL 9006 **05.01558.00**
- A** **05.01558.05**
- B** **05.01558.06**
- C** **05.01558.07**
- Universal** **05.01558.20**

- 05.01558.50**
- GD-AI, RAL 9006

30x30

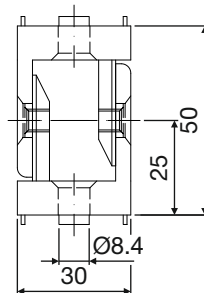
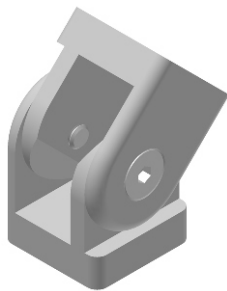

- GD-Zn **05.01855.00**
- A** **05.01855.05**
- B** **05.01855.06**
- C** **05.01855.07**
- Universal** **05.01855.20**

- RAL 9006 **05.01852.00**
- Universal** **05.01852.20**

- 05.01855.50**
- GD-Zn
- 05.01852.50**
- RAL 9006

Technische Änderungen vorbehalten

GELENKE JOINTS ARTICULATIONS



40x40

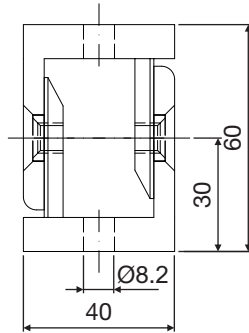
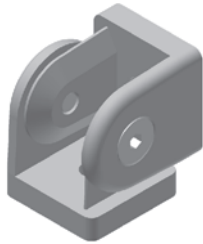

- 05.01856.00
- A** 05.01856.05
- B** 05.01856.06
- C** 05.01856.07
- Universal** 05.01856.20
- 05.01853.00
- Universal** 05.01853.20
-
- + 05.01856.50
- + 05.01853.50

45x45

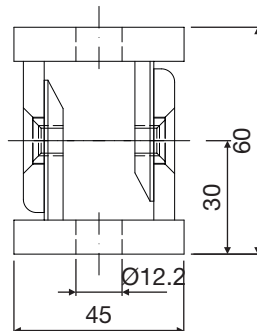
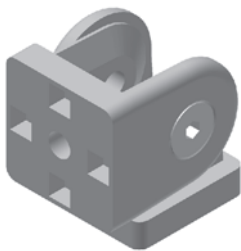

- 05.01857.00
- A** 05.01857.05
- B** 05.01857.06
- C** 05.01857.07
- Universal** 05.01857.20
- 05.01854.00
- Universal** 05.01854.20
-
- + 05.01857.50
- + 05.01854.50

Feststellen der Gelenke 30, 40 und 45

Um Gelenke feststellen zu können, müssen Sie die innenliegende Senkung (rot), um ca. 1 mm mit einem Kegelsenker nachsenken. Erst dann kann die Schraube, die beiden Gelenkhälften zusammenklemmen.

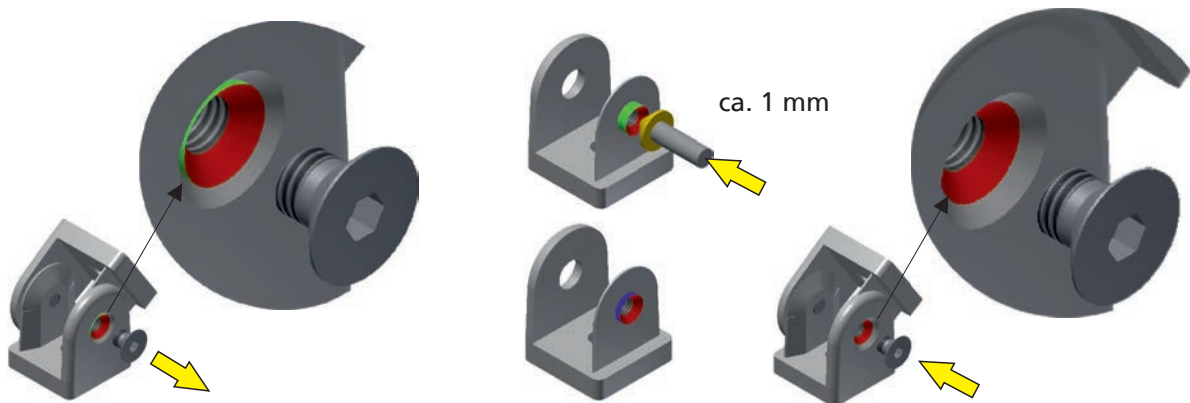

Technische Änderungen vorbehalten

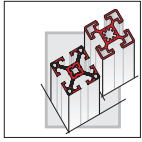

GELENKE JOINTS ARTICULATIONS



Innovative Vorteile:

- Mit einstellbarer Friktion zur stufenlosen Regulierung des Reibungswiderstandes bzw. zur Fixierung in einer definierten Position

Innovative advantages:

- With adjustable friction for step-free regulation of frictional resistance or to fasten in a specific position

Atouts novateur:

- Avec friction réglable, permettant la régulation progressive de la résistance à la friction ou pour la fixation à une position définie

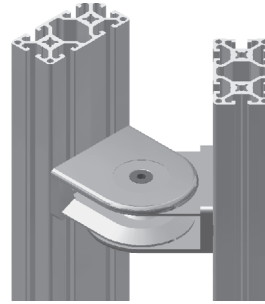
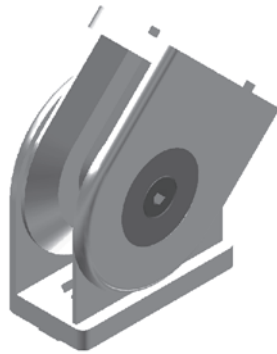

40x80

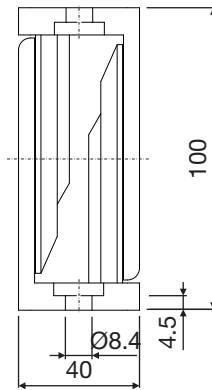
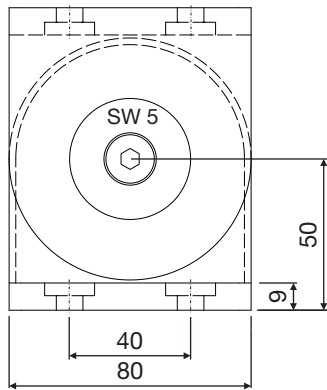

	05.01564.00
	05.01564.05
	05.01564.06
	05.01564.07

	05.01564.50
--	--------------------

45x90

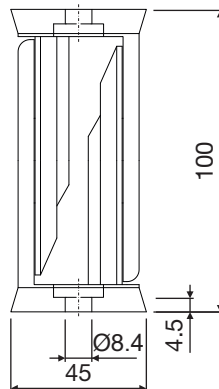
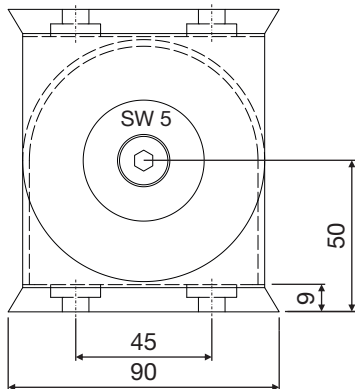

	05.01565.00
	05.01565.05
	05.01565.06
	05.01565.07

	05.01565.50
--	--------------------

Technische Änderungen vorbehalten

RÄDER, FÜSSE, PLATTEN WHEELS, FEETS, PLATES ROUES, PIEDS, EMBASES



■ 5.02



■ 5.04



■ 5.06



■ 5.08



■ 5.10

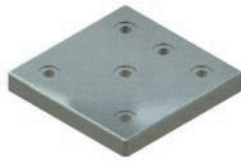

■ 5.12



■ 5.13



■ 5.13



■ 5.14



■ 5.17



■ 5.18



■ 5.20

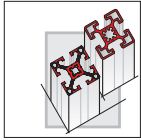

GEWINDEFÜSSE MIT KUNSTSTOFFTELLER

THREADED FEET WITH PLASTIC PLATE

PIEDS FILETÉS AVEC EMBASE POLYAMIDE



Ø30

M8 x 69
05.01480.00
M8 x 109
05.01481.00
M10 x 74
05.01482.00
M10 x 119
05.01483.00

Ø40/Ø45

M8 x 69
Ø40 05.01484.00
M8 x 109
Ø40 05.01485.00
M10 x 74
Ø40 05.01486.00
M10 x 119
Ø40 05.01487.00
M8 x 30
Ø45 05.01208.00
M10 x 30
Ø45 05.01209.00
M12 x 95
Ø40 05.01488.00
M12 x 129
Ø40 05.01489.00

Ø58

M12 x 95
05.01490.00
M12 x 129
05.01491.00
M16 x 95
05.01492.00
M16 x 129
05.01493.00

Ø80

M12 x 95
05.01625.00
M12 x 129
05.01626.00
M16 x 95
05.01627.00
M16 x 129
05.01628.00

GewindefüÙe mit Kunststoffteller
Threaded feet with plastic plate
Pieds filetés avec embase polyamide

- Ausführungen**
 Teller PA, schwarz
 Gewindespindel Stahl, verzinkt
- Designs**
 Plate PA, black
 Threaded spindle steel, galvanized
- Matières**
 Embase PA, noir
 Tige acier, zingué

Fmax ↓

M8 = 4000 N
M10 = 6000 N
M12 = 8000 N
M16 = 10000 N

Dämpfungsring
Damper ring
Semelle caoutchouc

Ø30 05.01480.90
Ø40 05.01484.90
Ø58 05.01490.90
Ø80 05.01625.90

Neigung bis zu 15° möglich
 Angles up to 15° possible
 Inclinaison max. 15°

Technische Änderungen vorbehalten

GEWINDEFÜSSE MIT STAHLTELLER

THREADED FEET WITH STEEL PLATE

PIEDS FILETÉS AVEC EMBASE ACIER



Ø30

M8 x 65

A 05.01450.00

Ø44

M12 x 85

A 05.01204.00

B 05.01452.00

M12 x 145

A 05.01205.00

B 05.01453.00

M16 x 85

A 05.01235.00

B 05.01237.00

M16 x 145

A 05.01236.00

B 05.01238.00

Ø58

M12 x 85

A 05.01454.00

B 05.01458.00

M12 x 145

A 05.01455.00

B 05.01459.00

M16 x 85

A 05.01456.00

B 05.01460.00

M16 x 145

A 05.01457.00

B 05.01461.00

Ø90

M16 x 85

A 05.01206.00

B 05.01462.00

M16 x 145

A 05.01207.00

B 05.01463.00

GewindefüÙe mit Stahlteiler
Threaded feet with steel plate
Pieds filetés avec embase acier

- Ausführungen**
 - Teller **A** Stahl, verzinkt
 - B** Stahl, schwarz beschichtet
 - Gewindespindel Stahl verzinkt
- Designs**
 - Plate **A** steel, galvanized
 - B** steel, black coated
 - Threaded spindle steel, galvanized
- Matières**
 - Embase **A** acier, zingué
 - B** acier, peinture noire
 - Tige acier, zingué

F_{max} ↓

M8 = 5000N
M10 = 8000N
M12 = 10000N
M16 = 20000N

Ø44 05.01465.00

Ø58 05.01466.00

Ø90 05.01467.00

Dämpfungsring
Damper ring
Semelle PU

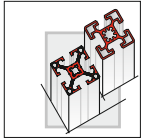

HÖHENVERSTELLER HEIGHT ADJUSTER PIEDS VERINS



1500N
F_{max} ↓

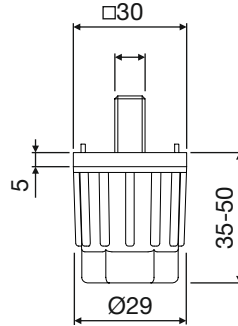

A



05.01468.00

B



1x

05.01870.00

PA 6
schwarz
black
noir



1500N
F_{max} ↓

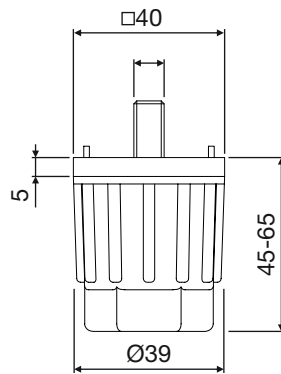

A



05.01464.00

B



1x

05.01652.00

PA 6
schwarz
black
noir

Anbau an Profilstirnseite
Connection on profile front side
Montage en bout de profilé

A



Anbau an Profilmutter
Connection to profile slot
Montage parallèle

B

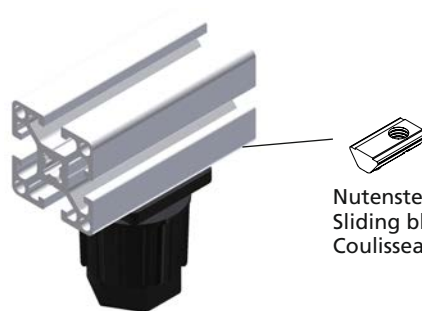

Nutenstein
Sliding block
Coulisseau

Technische Änderungen vorbehalten

RÄDER, FÜSSE, PLATTEN WHEELS, FEET, PLATES ROUES, PIEDS, EMBASES



Gewindefuß mit Trapezsteller

Threaded connector · Pieds atriculés

Ø 60: 25 kN
Ø 80: 30 kN

F_{max} ↓

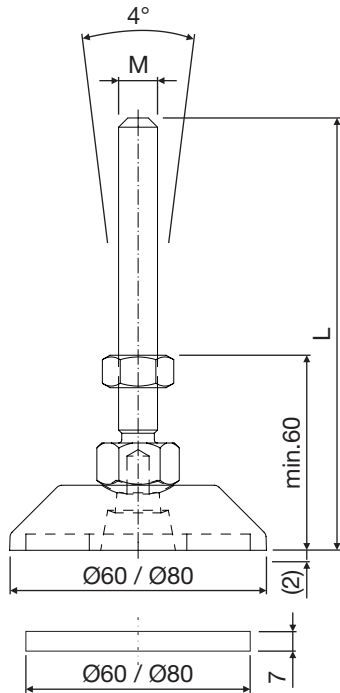

- **Ausführung**
Teller: Zinkdruckguss, schwarz beschichtet
Gewindespindel: Stahl, verzinkt; (VA)
- **Design**
Plate: Die-cast zinc, Black powder coated
Threaded spindle: steel, galvanized; (VA)
- **Matière**
Embase: Zamak, revêtu par poudre noir
Tige: acier, zingué; (VA)

Ø60	M12 x 86 05.02379.00	Ø80	M12 x 130 05.02381.00
	M12 x 120 05.02380.00		M12 x 160 05.02382.00
			M16 x 160 05.02384.00
			M16 x 220 05.02385.00
	Dämpfungsring Damping ring Bague d'amortissement		
Ø60	05.02379.90		
Ø80	05.02381.90		

5

Klemmlasche für Kunststoff- und Trapezsteller

Clamping strap · Fixation au sol

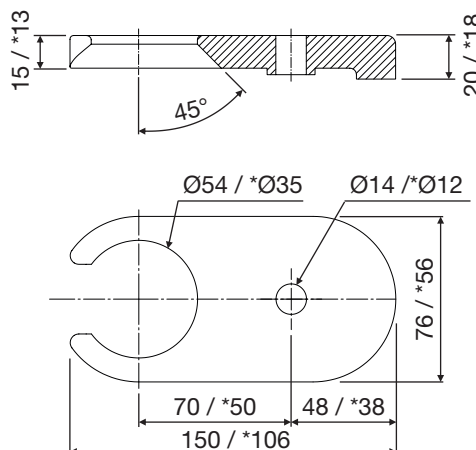

Gd-Zn

schwarz
black
noir

Ø 60*	05.01346.00
Ø 80	05.01347.00

Technische Änderungen vorbehalten

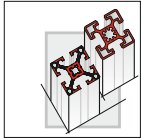

TRANSPORT- UND FUSSPLATTEN

TRANSPORT AND BASE PLATES





EMBASES D'EXTREMITE

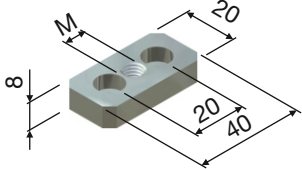

20x40 





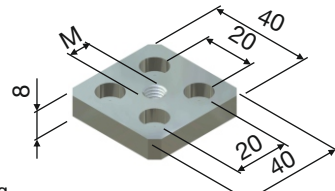

Profil stirnseitig
 Profile frontal
 Profil de la facade

	M5x20 (2x) ISO 4762		
	M5x8 (2x) ISO 4762		
	Nutenstein		
	5 M5 (2x)	M8	St, vz. 05.01826.00

40x40 





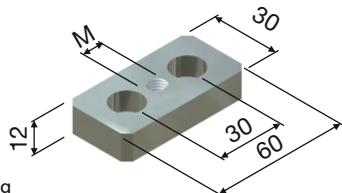

Profil stirnseitig
 Profile frontal
 Profil de la facade

	M5x20 (4x) ISO 4762	M8	St, vz. 05.01827.00
	M5x10 (4x) ISO 4762	M10	05.01828.00
	Nutenstein		
	5 M5 (4x)		

30x60 





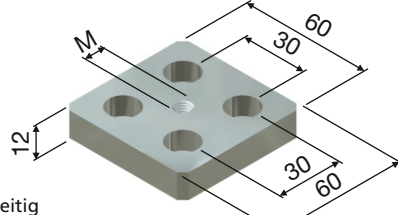

Profil stirnseitig
 Profile frontal
 Profil de la facade

	M8x20 (2x) ISO 4762	M8	St, vz. 05.01844.00
	M8x16 (2x) ISO 4762	M10	05.01845.00
	Nutenstein		
	8E M8 (2x)	M12	05.01846.00

60x60 





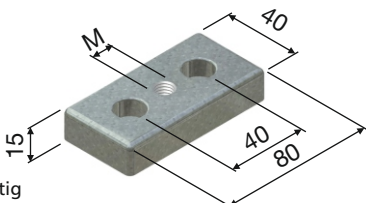

Profil stirnseitig
 Profile frontal
 Profil de la facade

	M8x20 (4x) ISO 4762	M8	St, vz. 05.01695.00*
	M8x16 (4x) ISO 4762	M10	05.01696.00*
	Nutenstein		
	8E M8 (4x)	M12	05.01697.00*

40x80 





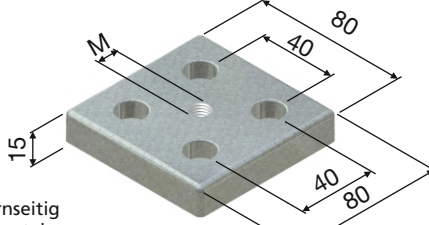

Profil stirnseitig
 Profile frontal
 Profil de la facade

	M8x20 (2x) ISO 4762	M10	GD-Zn 05.01225.00
	M8x16 (2x) ISO 4762	M12	05.01226.00
	Nutenstein		
	8E M8 (2x)	M16	05.01227.00

80x80 



Profil stirnseitig
 Profile frontal
 Profil de la facade

	M8x20 (4x) ISO 4762	M10	GD-Zn 05.01228.00
	M8x10 (4x) ISO 4762	M12	05.01229.00
	Nutenstein		
	8E M8 (4x)	M16	05.01230.00

Technische Änderungen vorbehalten

* auf Anfrage • on request • sur demande

TRANSPORT- UND FUSSPLATTEN

TRANSPORT AND BASE PLATES

EMBASES D'EXTREMITE



45x90

Profil stirnseitig - M12x40 (2x)
 Profile frontal - ISO 4762
 Profil de la facade - M8x16 (2x)

Profilnut - M10
 Profile groove - M12
 Rainure de profil - M16

- M8x16 (2x) ISO 4762
 - Nutenstein 10 M8 (2x) Scheibe ISO 7090 Ø8.4 (2x)

GD-Zn

M10	05.01294.00
M12	05.01295.00
M16	05.01296.00

90x90

Profil stirnseitig - M12x40 (4x)
 Profile frontal - ISO 4762
 Profil de la facade - M8x16 (4x)

Profilnut - M10
 Profile groove - M12
 Rainure de profil - M16

- M8x16 (4x) ISO 4762
 - Nutenstein 10 M8 (4x) Scheibe ISO 7090 Ø8.4 (4x)

GD-Zn

M10	05.01297.00
M12	05.01298.00
M16	05.01299.00

50x100

Profil stirnseitig - M12x40 (2x)
 Profile frontal - ISO 4762
 Profil de la facade - M8x16 (2x)

Profilnut - M12
 Profile groove - M12
 Rainure de profil - M16

- M8x16 (2x) ISO 4762
 - Nutenstein 10 M8 (2x) Scheibe ISO 7090 Ø8.4 (2x)

St, vz.

M12	05.01685.00
M16	05.01686.00

100x100

Profil stirnseitig - M12x40 (4x)
 Profile frontal - ISO 4762
 Profil de la facade - M8x16 (4x)

Profilnut - M12
 Profile groove - M12
 Rainure de profil - M16

- M8x16 (4x) ISO 4762
 - Nutenstein 10 M8 (4x) Scheibe ISO 7090 Ø8.4 (4x)

St, vz.

M12	05.01687.00
M16	05.01688.00

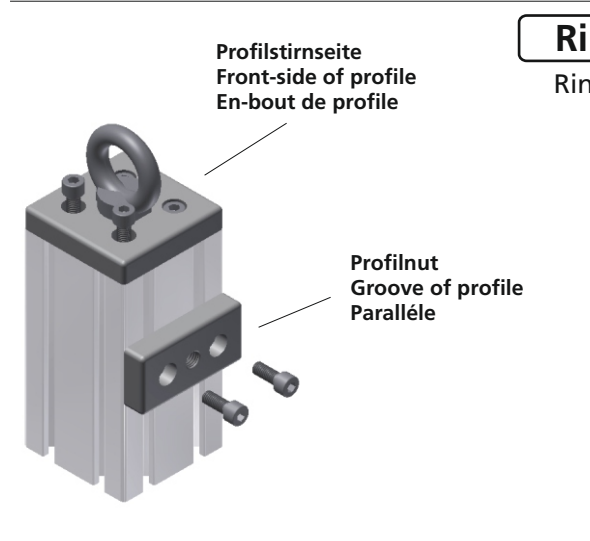

Ringschrauben

Ring bolt · Vis à anneau de levage

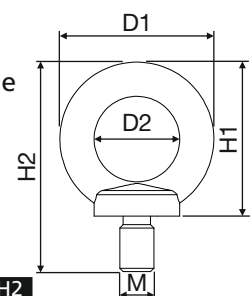

M	D1	D2	H1	H2	
M8	Ø36	Ø20	36	9	05.01446.00
M10	Ø45	Ø25	45	62	05.01447.00
M12	Ø54	Ø30	53	73.5	05.01448.00
M16	Ø63	Ø35	62	89	05.01449.00

Technische Änderungen vorbehalten

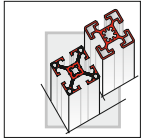

FUNDAMENTWINKEL

FOUNDATION BRACKET

EQUERRES D'ANCRAGE AU SOL



Ausführung links
Design left
Version gauche

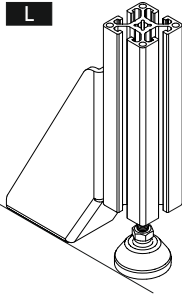

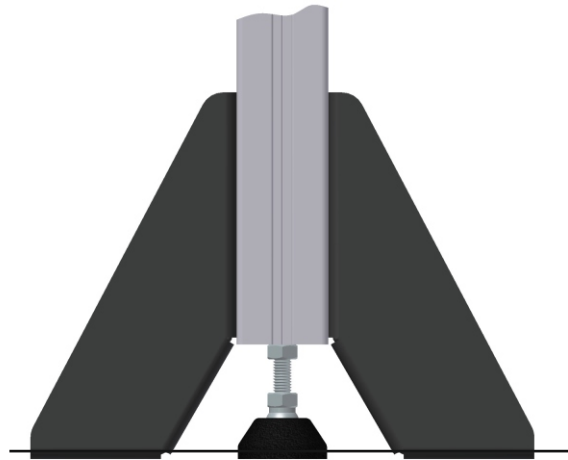
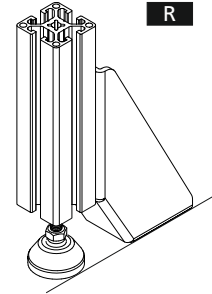

Ausführung rechts
Design right
Version droite



Stahl, schwarz beschichtet
Steel, black coated
Acier, peinture noire



 Befestigung mit
Hammerschrauben

 Fastened with
hammerhead screws

Fixation par vis 1/4
de tour

 Fundamentschraube
separat bestellen

Foundation screw
order separately

Cheville d'ancrage
commander séparément

160

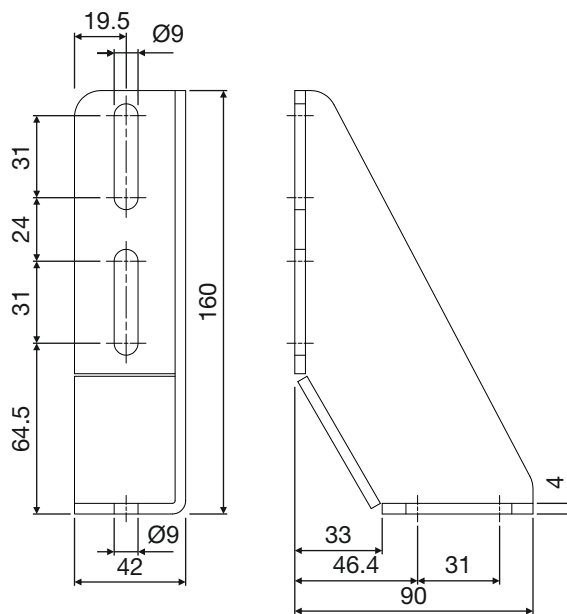

R 05.01168.00

R +  2x 05.01168.05

L 05.01169.00

L +  2x 05.01169.05

 1x 05.01172.00

Technische Änderungen vorbehalten

FUNDAMENTWINKEL FOUNDATION BRACKET EQUERRES D'ANCRAGE AU SOL



210

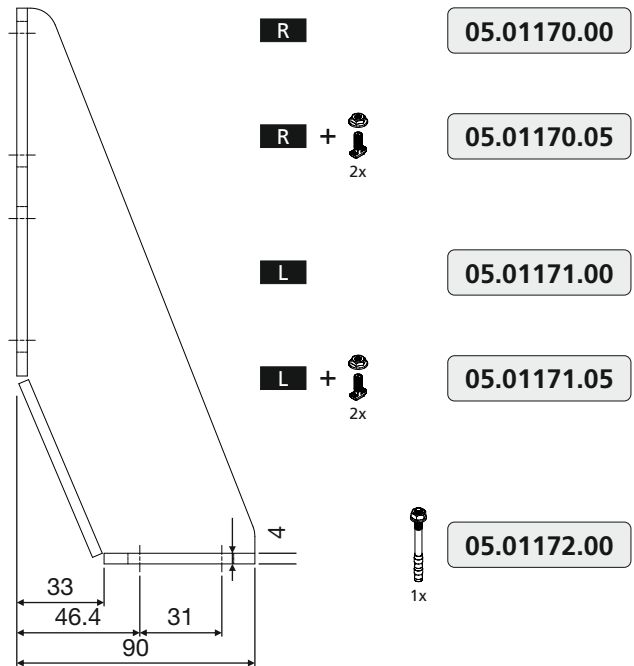
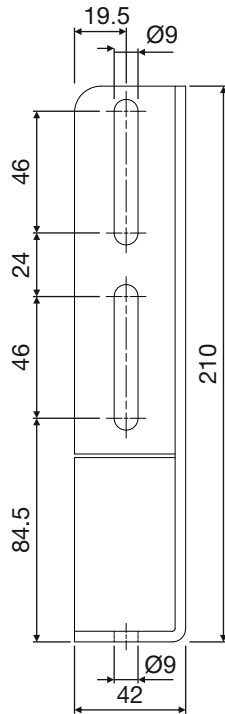

5

ECO

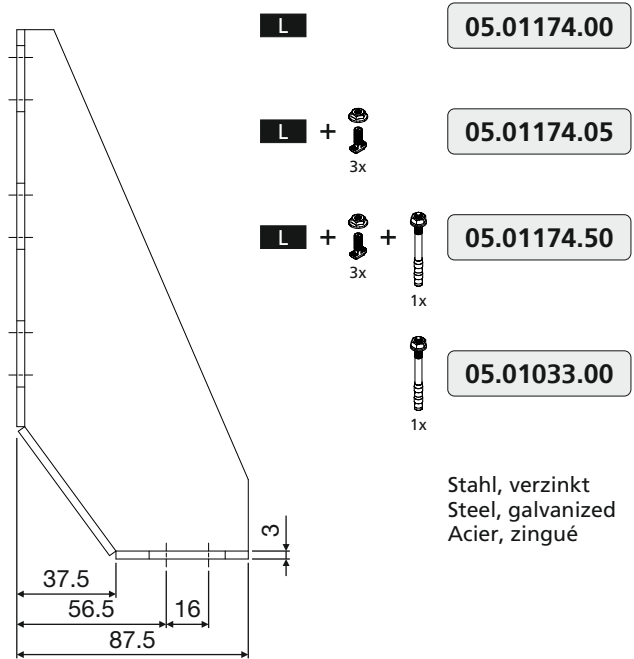
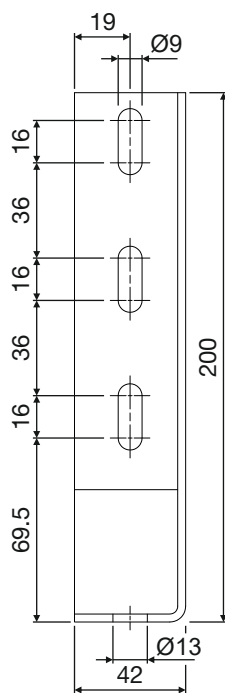

Technische Änderungen vorbehalten

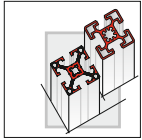

BODENWINKEL FLOOR BRACKETS EQUERRES D'ANCRAGE AU SOL



Bodenwinkel ohne Stellschraube
Floor bracket without adjusting screw
Equerre d'ancrage sans vis de réglage

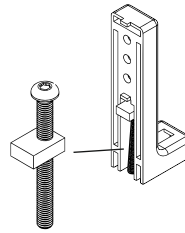
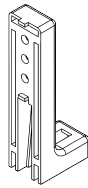

Bodenwinkel mit Stellschraube
Floor bracket with adjusting screw
Equerre d'ancrage avec vis de réglage

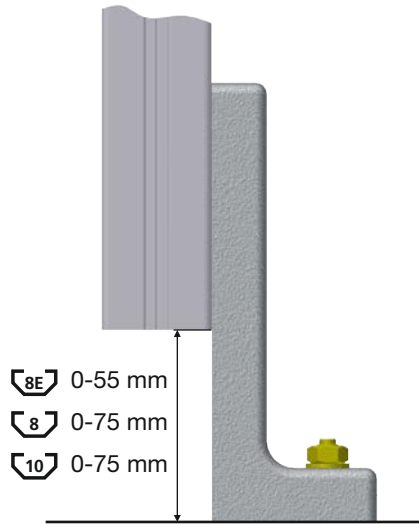

Befestigung mit
Verbinderschraube
Fastening with
connector screw
Fixation par vis ISO
et écrou à bille

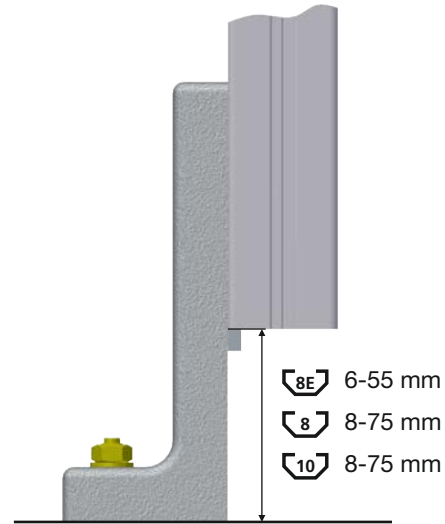

GD-Zn blank
bare nature

schwarz
black noir

05.xxxxx.0x

05.xxxxx.1x



Fundamentschraube
separat bestellen

Foundation screw
order separately

Cheville d'ancrage
commander séparément

05.01172.00

30x120

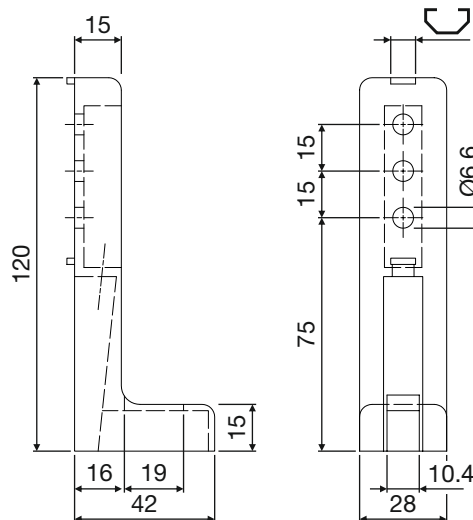

8E 8



05.02225.x0

8E



+
2x

05.02225.x5

8



+
2x

05.02225.x6

10



05.02199.x0

10



+
2x

05.02199.x5

Technische Änderungen vorbehalten

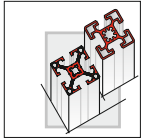

BODENPLATTEN BASE PLATES EMBASES DE PIÈTEMENT

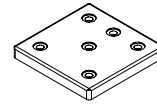
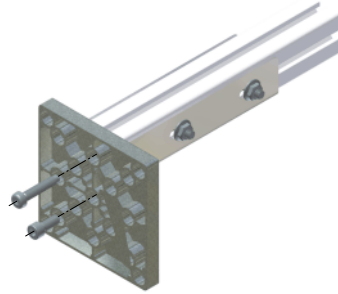
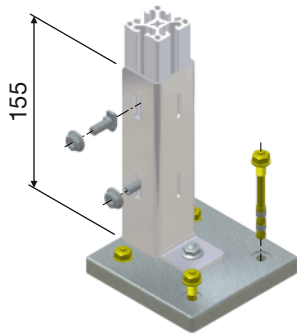

Bodenplatte
Base Plate
Embase de piètement

GD-Zn



Stützwinkel
Support Bracket
Fourreau

St, vz

Vielseitige Anordnung der Profile
40x40, 40x80 und 80x80 bzw.
45x45, 45x90 und 90x90 möglich.

Versatile arrangement of profiles
40x40, 40x80 and 80x80 or
45x45, 45x90 and 90x90 possible.

Nombreuses possibilités d'agencement
des profilés 40x40, 40x80 und 80x80 ou
45x45, 45x90 et 90x90.

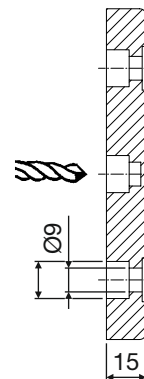
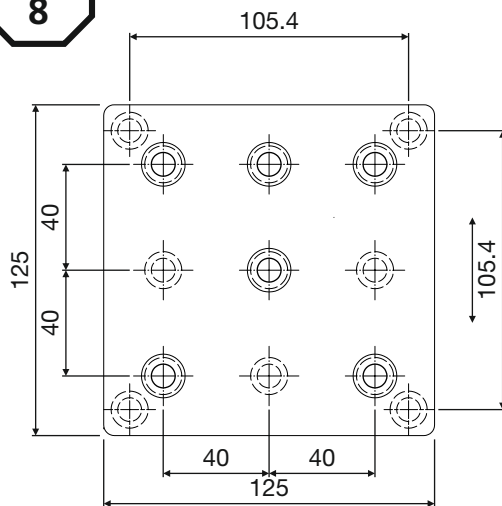

05.02040.00



05.01125.00



05.02042.00

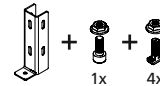

05.02042.05



05.01172.00

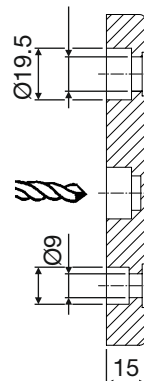
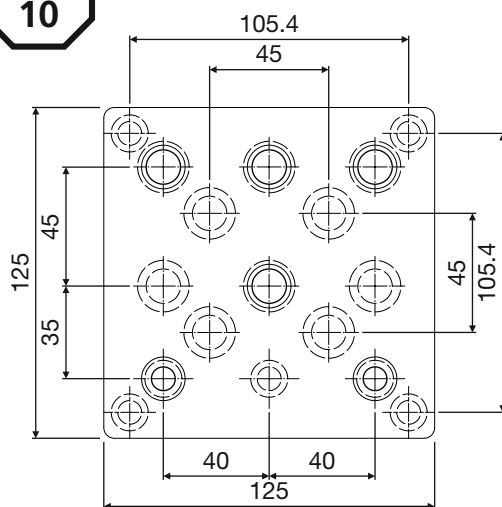

05.02041.00



05.01127.00



05.02043.00

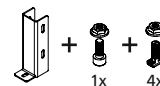

05.02043.05



05.01172.00

Technische Änderungen vorbehalten

Stützstrebe

Support strut · Bras de renfort

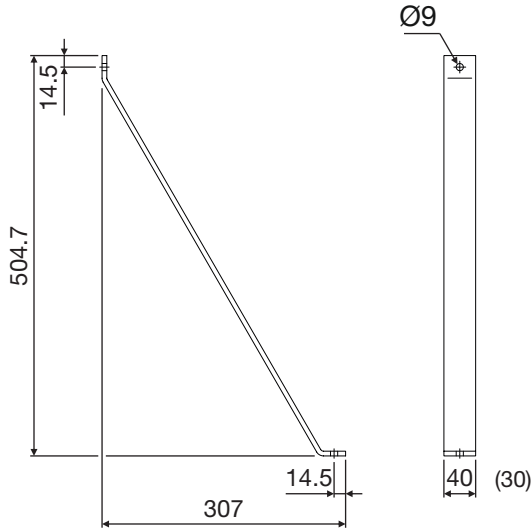

Stahl, verzinkt
 Steel, galvanized
 Acier, zingué

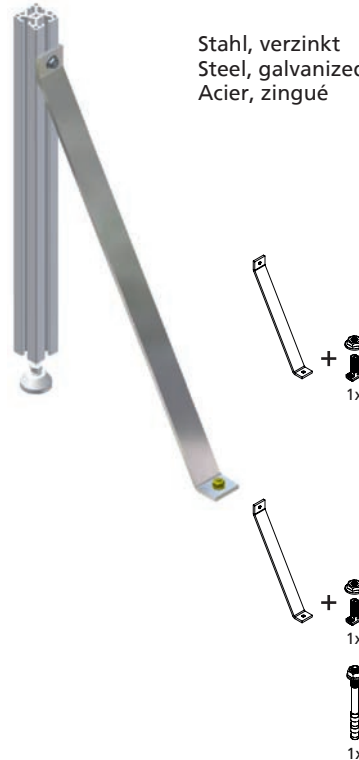

B=30 mm

05.02376.00

05.02376.05

B=40 mm

05.02038.00

05.02038.05

05.01172.00



Fundamentschraube

Foundation screw · Cheville d'ancrage

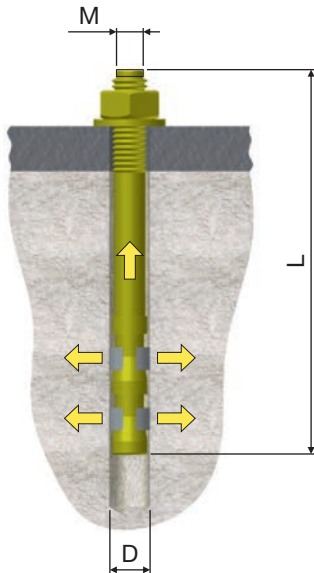

M	L	D	
M8	86	Ø9	05.01172.00
M12	156	Ø13	05.01033.00



Stahl, verzinkt
 Steel, galvanized
 Acier, zingué

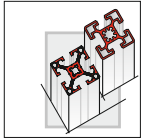

TRANSPORT- UND LENKROLLEN

TRANSPORT AND GUIDE ROLLERS

ROULETTES DE TRANSPORT ET ROUES GUIDE



A

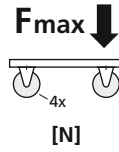
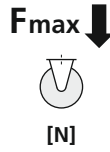
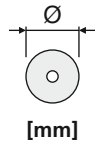

Varianten
Versions
Variantes

Ø50

500

1500

➔ ■ 5.17



B



Ø75

600

1800

➔ ■ 5.18



Ø100

700

2100

➔ ■ 5.18



C



Ø80

600

1800

➔ ■ 5.19



Ø125

1000

3000

➔ ■ 5.19



D



Ø80

1250

3750

➔ ■ 5.20



Ø125

1500

4500

➔ ■ 5.20



Ø160

3000

9000

➔ ■ 5.20

Technische Änderungen vorbehalten

TRANSPORT- UND LENKROLLEN

TRANSPORT AND GUIDE ROLLERS

ROULETTES DE TRANSPORT ET ROUES GUIDE



Rolle für geringe Lasten und glatte Böden geeignet.

Ausführung: Kunststoff PA 6

Roller suitable for small loads and level smooth surfaces.

Finish: Plastic PA 6

Roulette adaptée pour faibles charges et sols plans.

Matière : PA 6

Kostengünstige Rolle für leichte bis mittlere Lasten bei Industrieböden.

Gehäuse: Stabiles Stahlblech, gepresst, verzinkt-chromatiert
Drehkranz: Zweifache Kugellagerung, minimales Spiel, für leichtgängigen Lauf
Achse: Stahl verzinkt, Gleitlagerung
Rad: Vollgummi, grau, 80° Shore A

Radkörper: Polyamid, schwarz

Economical rollers for light to medium loads on industrial floors.

Housing: Sturdy sheet steel, Pressed, zinc-chromatised
Bearing ring: Twin ball Bearing, minimum play for easy running

Axle: Steel galvanized, slide
Wheel: Solid rubber, grey, 80° Shore A
Wheel casing: Polyamide, black

Roulettes de prix avantageux pour charges légères à moyennes sur sols industriels.

Carter : Tôle d'acier robuste, matricé, zingué, chromaté
Couronne de pivotement : Double roulement à billes, faible jeu, grande souplesse de roulement

Axe : Acier zingué, coussinet lisse
Roue : Caoutchouc plein, gris 80° shore A
Corps de roue : Polyamide, noir

Rolle in guter Qualität für leichte bis mittlere Lasten bei Industrieböden.

Gehäuse: Stabiles Stahlblech, gepresst, verzinkt-chromatiert
Drehkranz: Zweifache Kugellagerung, minimales Spiel, für leichtgängigen Lauf
Achse: Stahl verzinkt, Kugellagerung
Rad: Vollgummi, grau, 80° Shore A

Radkörper: Polyamid, schwarz

Good quality rollers for light to medium loads on industrial floors.

Housing: Sturdy sheet steel, pressed, zinc-chromatised
Bearing ring: Twin ball bearing, minimum play for easy running

Axle: Steel galvanized, ball bearing
Wheel: Solid rubber, grey, 80° Shore A
Wheel casing: Polyamide, black

Roulette de bonne qualité pour charges légères à moyennes sur sols industriels.

Carter : Tôle d'acier robuste, matricé, zingué, chromaté
Couronne de pivotement : Double roulement à billes, faible jeu, grande souplesse de roulement

Axe : Acier zingué, roulement à billes
Roue : Caoutchouc plein, gris 80° shore A
Corps de roue : Polyamide, noir

Stabile, robuste Rolle für mittlere bis schwere Lasten.

Gehäuse: Stabiles Stahlblech, gepresst, verzinkt-chromatiert
Drehkranz: Zweifache Kugellagerung, minimales Spiel, für leichtgängigen Lauf
Achse: Stahl verzinkt, Gleitlagerung
Rad: Vollgummi, grau, 98° Shore A, abriebfest
Radkörper: Polyamid, hellgrau

Sturdy and rugged rollers for medium to heavy loads.

Housing: Sturdy sheet steel, pressed, zinc-chromatised
Bearing ring: Twin ball bearing, minimum play for easy running

Axle: Steel galvanized, slide
Wheel: Solid rubber, grey, 98° Shore A, abrasion-proof
Wheel casing: Polyamide, light grey

Roulette stable et robuste pour charges moyennes à lourdes

Carter : Tôle d'acier robuste, matricé, zingué, chromaté
Couronne de pivotement : Double roulement à billes, faible jeu, grande souplesse de roulement

Axe : Acier zingué, coussinet lisse
Roue : Caoutchouc plein, gris 98° shore A, résistant à l'usure
Corps de roue : Polyamide, gris clair

Fahr-Stopp-Rolle mit besten Laufeigenschaften und hoher Belastbarkeit für einen sicheren Stand.

Drive-Stop roller with top running characteristics and high load capacity, offering secure stand.

Roulette STOP&GO, excellentes propriétés de roulement et grande capacité de charge, offrant une grande stabilité.

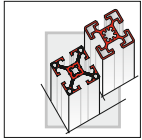

TRANSPORT- UND LENKROLLEN
TRANSPORT AND GUIDE ROLLERS
ROULETTES DE TRANSPORT ET ROUES GUIDE



A



■ 5.17

B

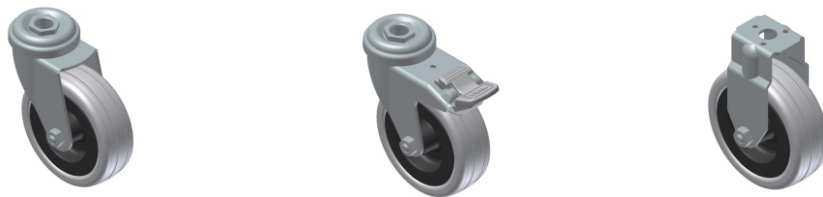

■ 5.18

C

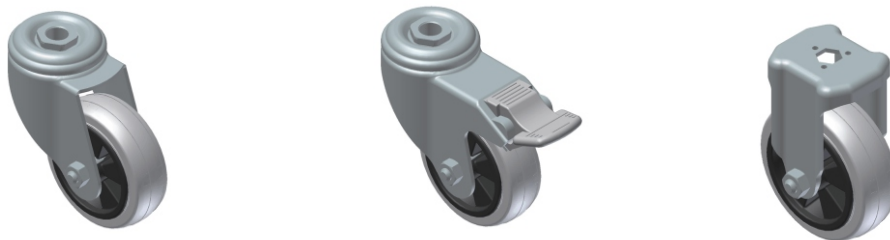

■ 5.19

D

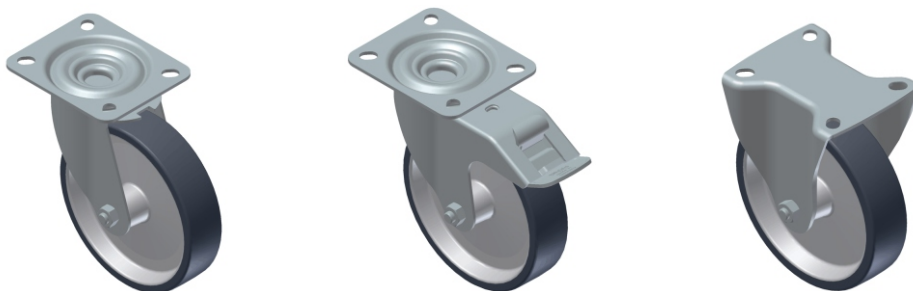

■ 5.20

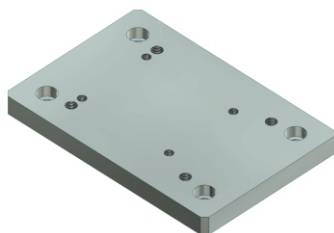

■ 5.24

Technische Änderungen vorbehalten

DOPPELROLLE MIT / OHNE FESTSTELLER
DOUBLE ROLLER WITH / WITHOUT FASTENER
ROULETTE LEGERE AVEC / SANS BLOCAGE



Ø50 - stirnseitig

Ø50 front side · Ø50 coté frontal



05.01211.00



05.01213.00

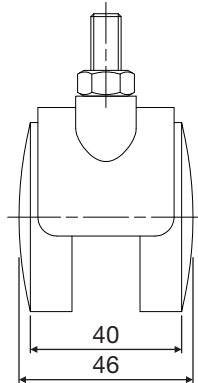
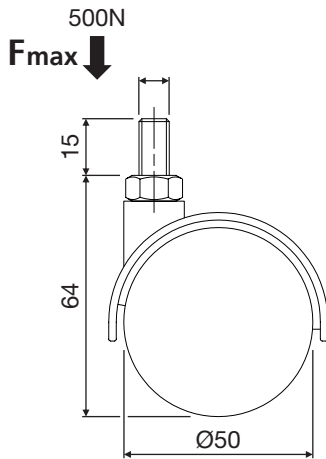

Anbausatz
Adapter kit
Kit de montage



05.01248.00



05.01248.10

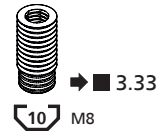

05.01372.00

5

Ø50 - nutseitig

Ø50 groove side · Ø50 montage parallèle



05.01210.00



05.01212.00

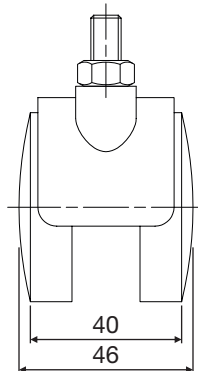
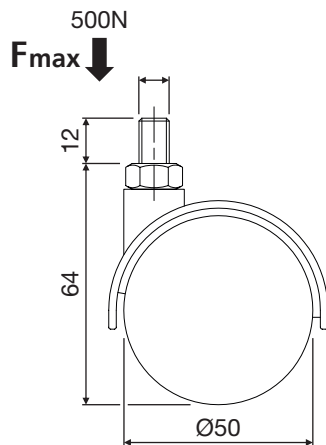

Anbausatz
Adapter kit
Kit de montage



05.01249.00



05.01070.00

Technische Änderungen vorbehalten

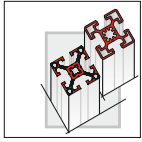

ROLLEN MIT RÜCKENLOCH
ROLLERS WITH REAR HOLE
ROULETTES AVEC TROU CENTRAL



Ø75

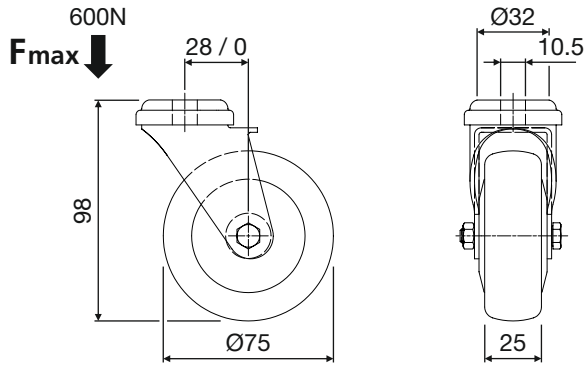

- 05.01241.00**
- 05.01975.00**
- 05.01240.00**
- 05.01976.00**
- 05.01242.00**
- 05.01977.00**

Ø100

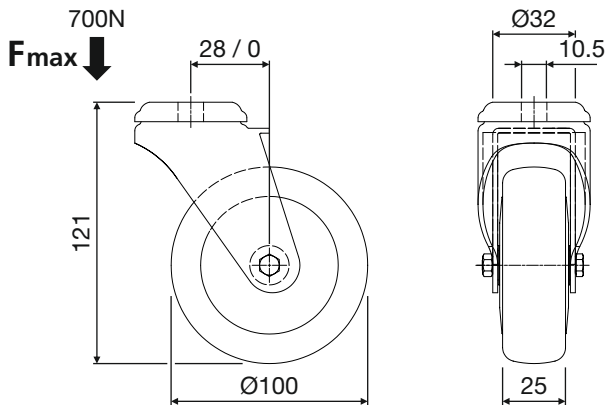

- 05.01244.00**
- 05.01978.00**
- 05.01243.00**
- 05.01979.00**

Anbausatz Profilstirnseite
Front-side profile adapter kit
Kit de montage en bout

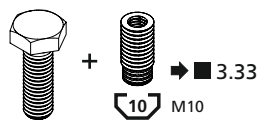
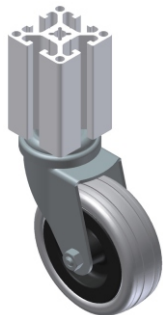

- 8** M8x40
- 10** M10x40

- 8** **05.01998.00**
- 10** **05.01999.00**

Anbausatz Profilnut
Groove profile adapter kit
Kit de montage parallèle

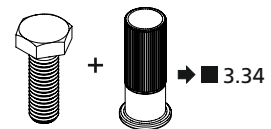
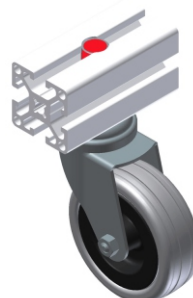

- 8E** M8x30
- 8** **10** M10x40

- 8E** **05.01681.00**
- 8** **10** **05.01997.00**

Technische Änderungen vorbehalten

ROLLEN MIT RÜCKENLOCH
ROLLERS WITH REAR HOLE
ROULETTES AVEC TROU CENTRAL



Ø80

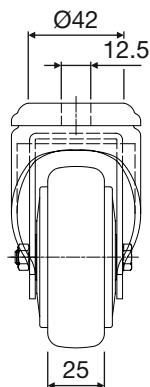
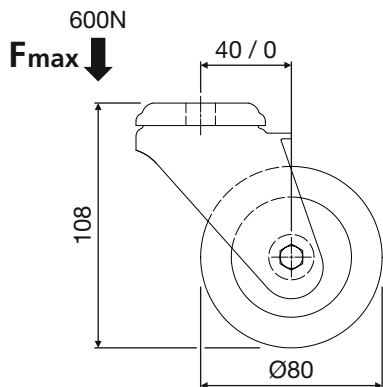

- 05.01214.00**
- 05.01380.00**
- 05.01216.00**
- 05.01381.00**
- 05.01220.00**
- 05.01387.00**

Ø125

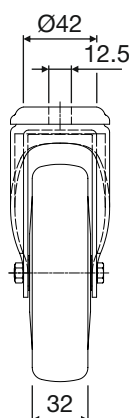
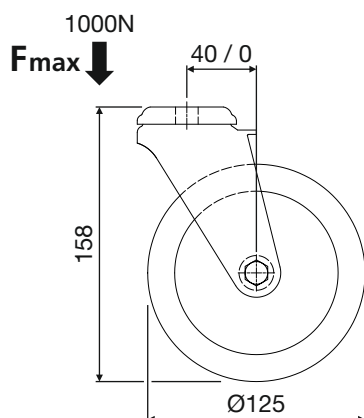

- 05.01215.00**
- 05.01382.00**
- 05.01217.00**
- 05.01383.00**
- 05.01219.00**
- 05.01386.00**

Anbausatz Profilstirnseite
 Front-side profile adapter kit
 Kit de montage en bout

- 8** M12x30
- 10** M12x45
- 8** **05.01218.00**
- 10** **05.01218.10**

Anbausatz Profilnut
 Groove profile adapter kit
 Kit de montage parallèle

- 8** M12x45
- 10** M12x45
- 8** **05.01384.00**
- 10** **05.01384.10**

Technische Änderungen vorbehalten

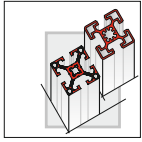

ROLLEN MIT ANSCHRAUBPLATTE
ROLLERS WITH SCREW ON PLATE
ROULETTES AVEC PLATINE



Ø80

Ø125

A

B

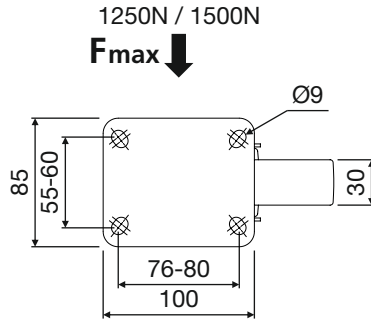
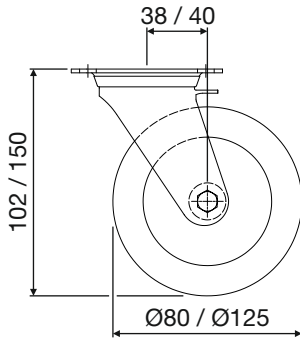

A 05.01549.00

B 05.01246.00

A 05.01548.00

B 05.01245.00

B 05.01247.00

Ø160

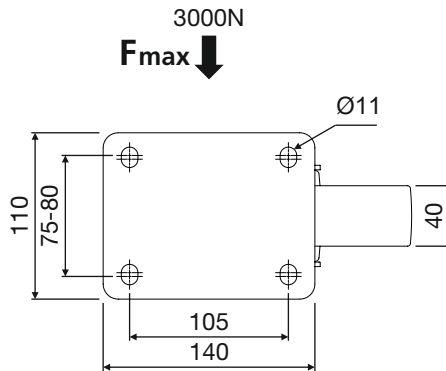
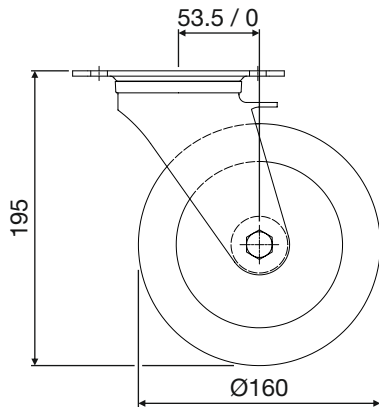

05.01521.00

05.01520.00

05.01522.00

Anbausatz Profilstirnseite
Front-side profile adapter kit
Kit de montage en bout

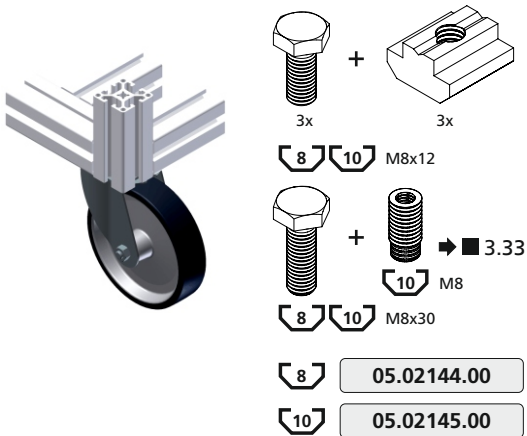

Anbausatz Profilnut
Groove profile adapter kit
Kit de montage parallèle

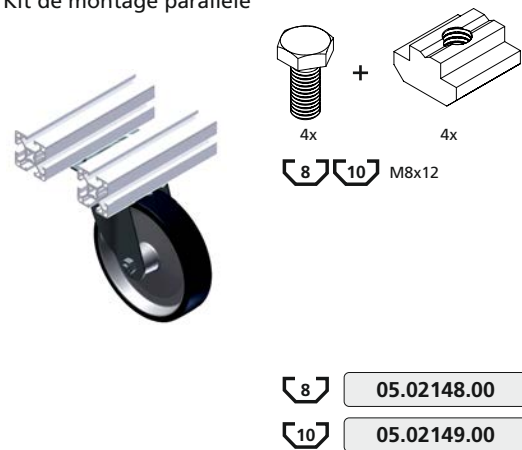

Technische Änderungen vorbehalten

FADENSCHUTZ
THREAD COVERS
PARE-FILS



<p>Ø75 ➔ ■ 5.18</p>  <p>Stahl, verzinkt Steel, galvanized Acier, zingué</p> <p> 05.01524.00</p>	<p>Ø80 ➔ ■ 5.19</p>  <p>Stahl, verzinkt Steel, galvanized Acier, zingué</p> <p> 05.01525.00</p>
<p>Ø100 ➔ ■ 5.18</p>  <p>Stahl, verzinkt Steel, galvanized Acier, zingué</p> <p> 05.01526.00</p>	<p>Ø125 ➔ ■ 5.19</p>  <p>Stahl, verzinkt Steel, galvanized Acier, zingué</p> <p> 05.01527.00</p>
<p>Ø125 ➔ ■ 5.20</p>  <p>Stahl, verzinkt Steel, galvanized Acier, zingué</p> <p> 05.01529.00</p>	<p>Ø160 ➔ ■ 5.20</p>  <p>Stahl, verzinkt Steel, galvanized Acier, zingué</p> <p> 05.01539.00</p>

Technische Änderungen vorbehalten

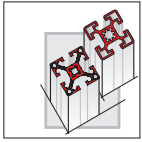

ANSCHRAUBPLATTE SCREW-ON PLATE INTERFACE ROULETTE



Anwendung

Application · Application

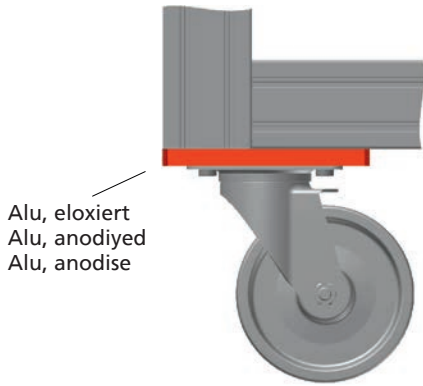

Alu, eloxiert
Alu, anodiyed
Alu, anodise

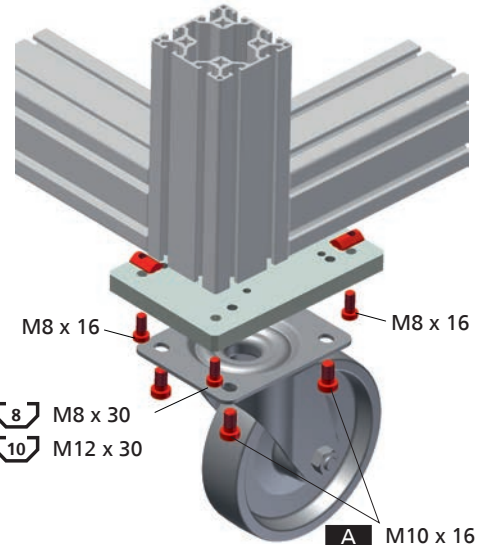

M8 x 16 M8 x 16

8 M8 x 30
10 M12 x 30

A M10 x 16
B M8 x 16

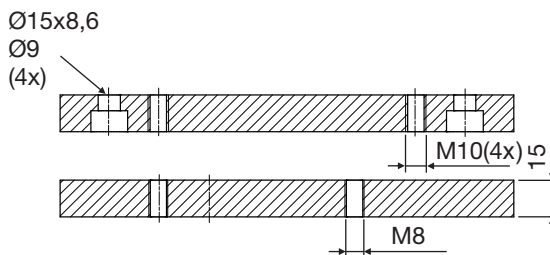
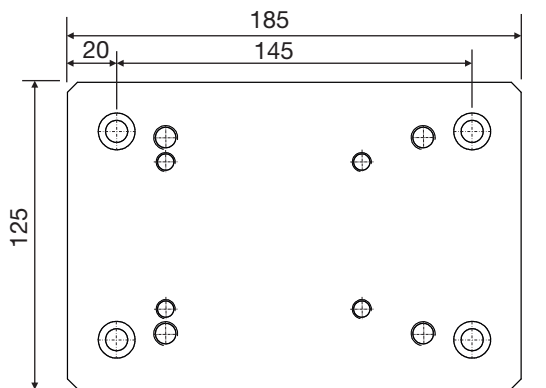
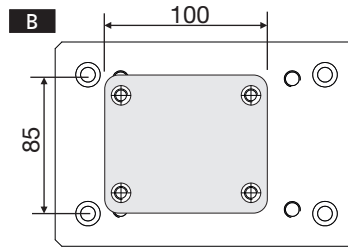
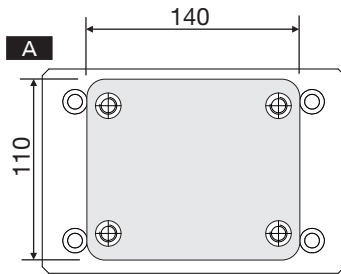

➔ 5.20

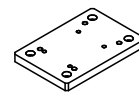

05.01582.00

Anbausatz
Adapter kit
Kit de montage

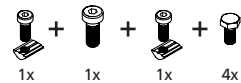

A 8 05.01583.00

B 8 05.01583.10

A 10 05.01584.00

B 10 05.01584.10

Technische Änderungen vorbehalten

ZUBEHÖR
ACCESSORIES
ACCESSOIRES



■ 6.02

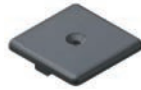

■ 6.04

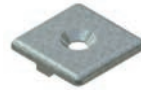

■ 6.05



■ 6.06



■ 6.07



■ 6.08

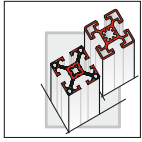

ABDECKKAPPEN KUNSTSTOFF

CAPS PLASTIC

CACHES PLASTIQUE



Typ A

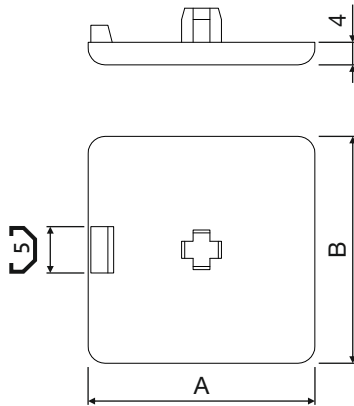

PA 6 schwarz
black
noir

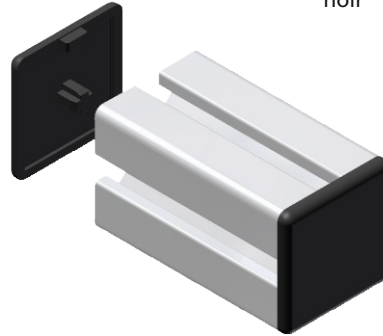

16

8S



A x B

16 x 40 05.01740.00

16 x 80 05.01741.00

16 x 120 05.01748.00

16 x 160 05.01747.00

20

5



A x B

10 x 20 05.02270.00

20 x 20 05.01742.00

20 x 40 05.01743.00

40 x 40 05.01744.00

30

8E

30 x 30 05.01183.00

30 x 60 05.01587.00

30 x 30-R 05.01773.00

30^{10K}

8K

30 x 30 05.02125.00

30 x 60 2x 30x30

40

8

40 x 40 05.01175.00

40 x 80 05.01176.00

40 x 120 05.01786.00

40 x 160 05.01188.00

80 x 80 05.01177.00

80 x 120 05.01787.00

80 x 160 05.01785.00

40 x 40-R 05.01728.00

40 x 40-45° 05.01745.00

40^R

8

40R80-30° 05.01724.00

40R80-45° 05.01725.00

40R80-60° 05.01726.00

40R80-90° 05.01727.00

40^{10K}

8

40 x 40 05.01311.00

40 x 80 05.01312.00

Technische Änderungen vorbehalten

ABDECKKAPPEN KUNSTSTOFF

CAPS PLASTIC

CACHES PLASTIQUE



45 x 45	05.01178.00
45 x 60	05.01179.00
45 x 90	05.01180.00
45 x 180	05.02371.00
60 x 60	05.01181.00

60 x 90	05.01738.00
90 x 90	05.01182.00
90 x 90S	05.01739.00
45 x 45-R	05.01774.00



50 x 50	05.01720.00
50 x 100	05.01721.00
100x100	2x 50x100

Typ B

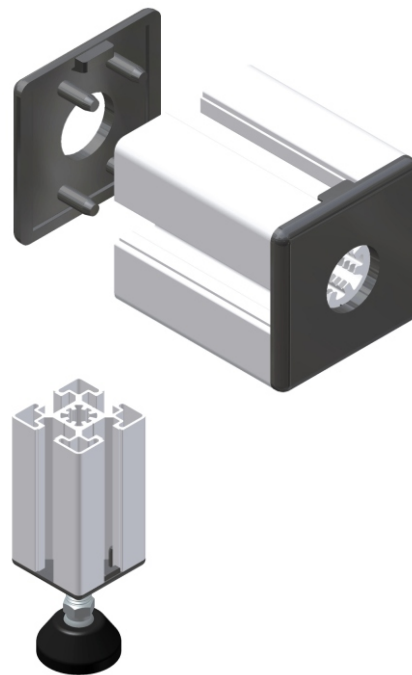
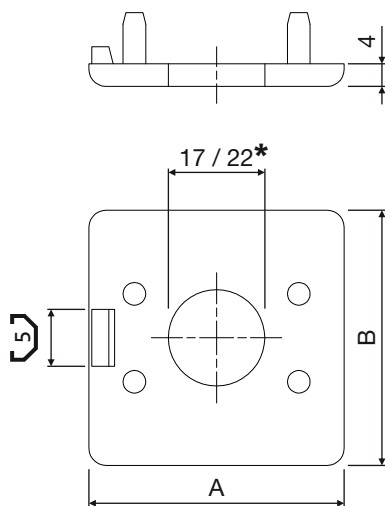

PA 6
schwarz
black
noir

6



A x B	
45 x 45	05.01184.00
45 x 60	05.01185.00
60 x 60	05.01345.00



A x B	
50 x 50	05.01723.00

Technische Änderungen vorbehalten

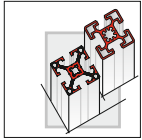

ABDECKKAPPEN EINSCHLAGSCHRAUBE

CAPS WITH IMPACT SCREWS

CACHES AVEC A VIS

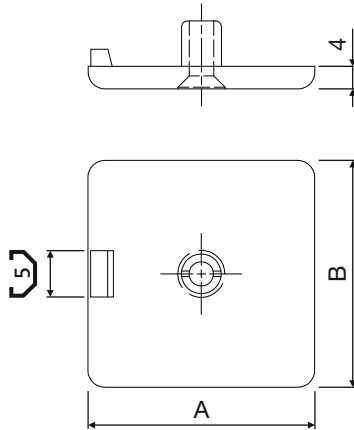

M4 x 16

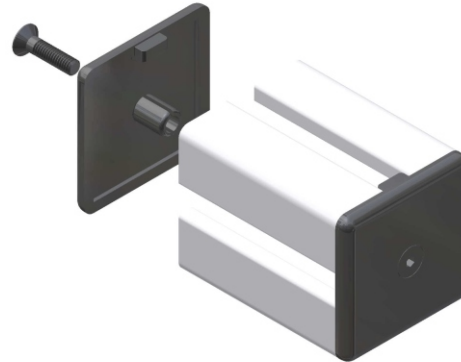

PA 6
schwarz
black
noir

1. ... platzieren
position
positionner



2. ... einschlagen
knock in
enfonceur

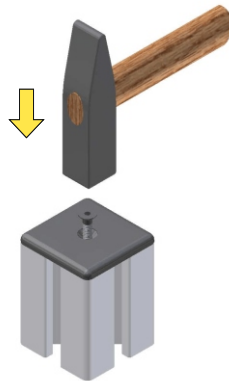

3. ... lösen
undo
dévissier

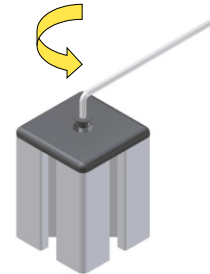

30

8E



A x B

30 x 30

05.01775.00

30 x 60

05.01779.00

40

8



A x B

40 x 40

05.01776.00

40 x 80

05.01777.00

80 x 80

05.01778.00

45

10

45 x 45

05.01788.00

45 x 60

05.01789.00

45 x 90

05.01790.00

60 x 60

05.01791.00

90 x 90

05.01792.00





Technische Änderungen vorbehalten

ABDECKKAPPEN ZINKDRUCKGUSS
CAPS DIECAST ZINC
CACHES ZINC MOULE SOUS PRESSION

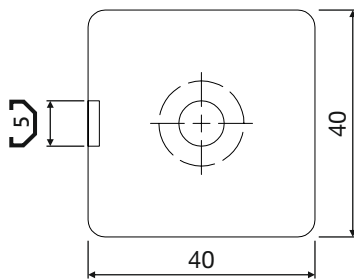
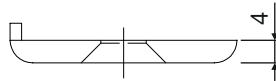
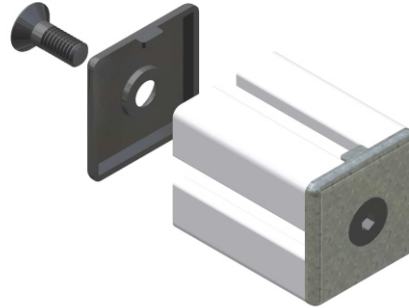

SF 7.1 x 16







- * **A** GD-Zn natur natural finish naturel  +  1x **05.01734.05**
- * **B** GD-Zn schwarz black noir  +  1x **05.01735.05**

* Nicht geeignet für Profil: 40x40 EL 1.4
 Not suitable for profile:
 Ne convient pas pour le profilé :

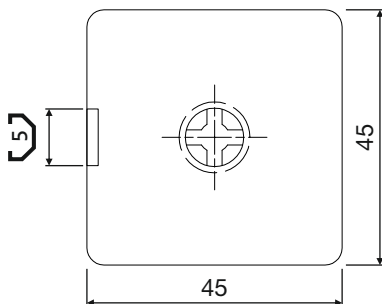
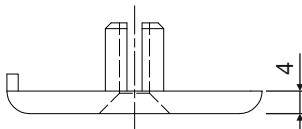
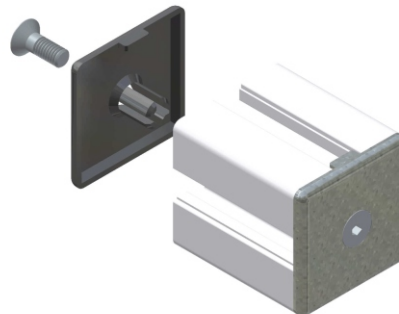

M6 x 16



- * **A** GD-Zn natur natural finish naturel  +  1x **05.01736.05**
- * **B** GD-Zn schwarz black noir  +  1x **05.01737.05**

Technische Änderungen vorbehalten

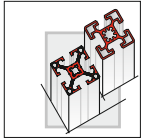

RADIUSAUSGLEICH RADIAL COMPENSATION JOINT DE CONNEXION

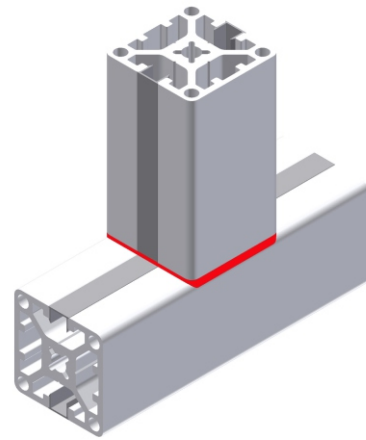
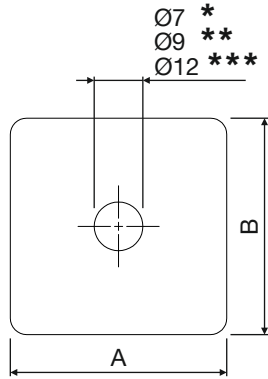
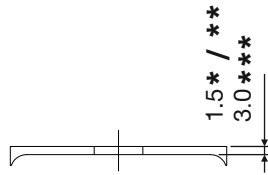

PA 6
lichtgrau
light grey
gris clair

30 **8E** * 30 x 30 05.01690.00

40 **8** ** 40 x 40 05.01691.00

45 **10** *** 45 x 45 05.01719.00

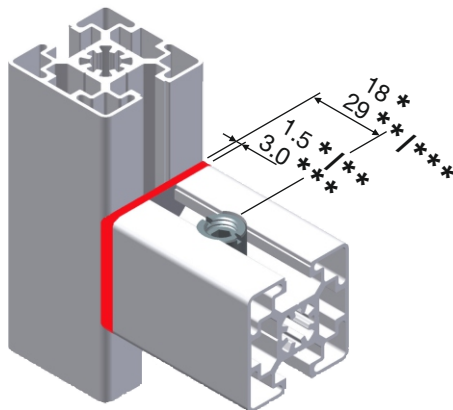

Maße bei der Profilbearbeitung berücksichtigen
Take dimensions into account for profile processing
Cotes à prendre en compte pour l'usinage du profilé
➡ ■ 3.02 / ➡ ■ 3.16

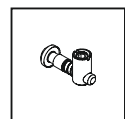
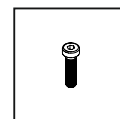

Technische Änderungen vorbehalten

SCHIENENGLEITER SLIDE HANGER COULISSEAU



Schienengleiter

Slide hanger · Coulisseau

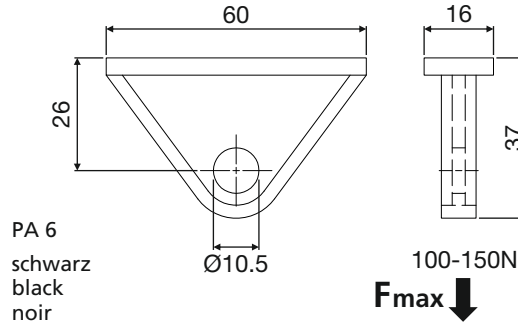
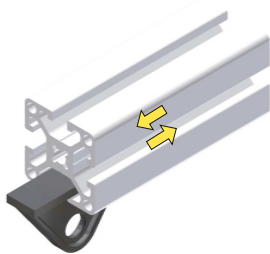

PA 6
schwarz
black
noir



05.01192.00

6

Karabinerhaken

Snap hook · Mousqueton

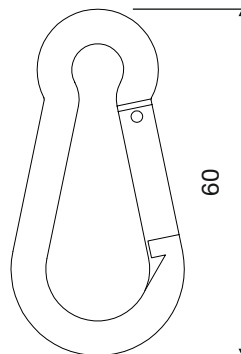
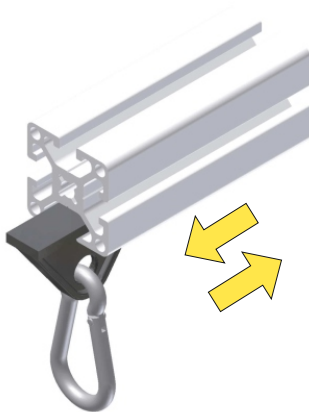

05.01193.00

Technische Änderungen vorbehalten

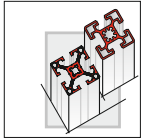

LAUFROLLEN

ROLLERS

GALETS



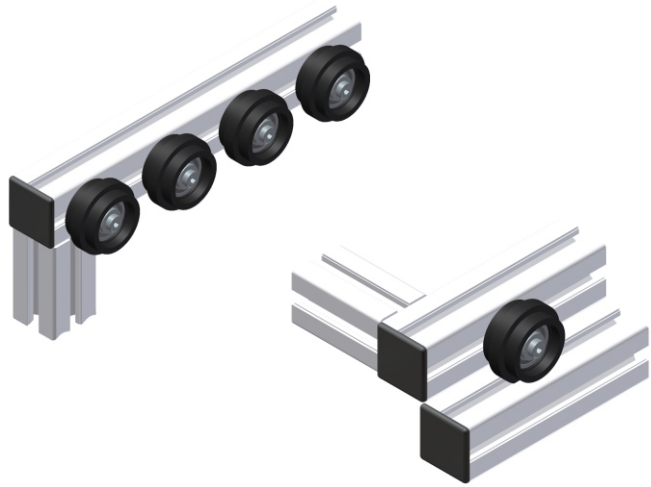
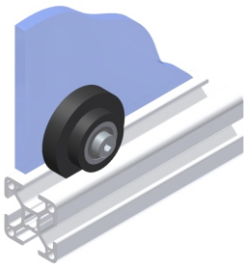

PA 6
schwarz
black
noir



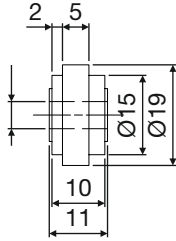

Typ A 

50N
F_{max} ↓





Gleitlager
Slide bearing
Cousinet lisse

05.01624.00

Typ B  

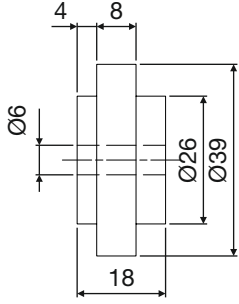
150
F_{max} ↓





Kugellager
Ball bearing
Roulement à billes

05.01622.00

Typ C 

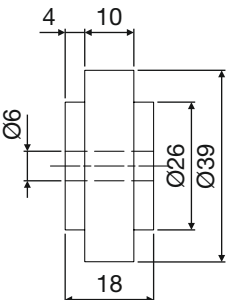
150
F_{max} ↓





Kugellager
Ball bearing
Roulement à billes

05.01623.00

Typ D 

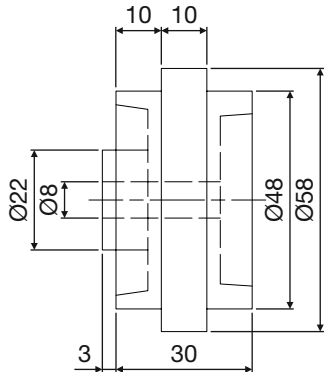
150
F_{max} ↓





Kugellager
Ball bearing
Roulement à billes

05.01638.00

Technische Änderungen vorbehalten

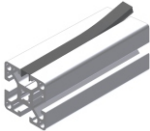
FLÄCHENELEMENTE
SURFACE ELEMENTS
REEMPLISSAGE



■ 7.02

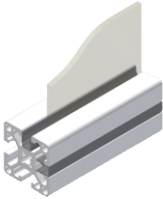

■ 7.03

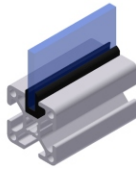

■ 7.04



■ 7.05



■ 7.06

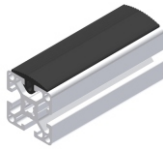

■ 7.06

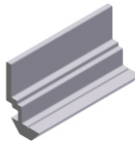

■ 7.07



■ 7.08

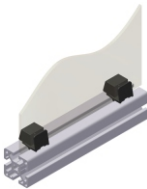

■ 7.09

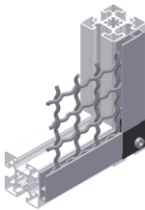

■ 7.10



■ 7.12

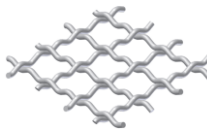

■ 7.14

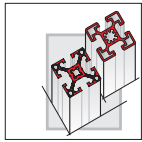

ABDECKPROFILE COVER PROFILES PROFILES DE PROTECTION



Innovative Vorteile

- Schließen der Profilfläche
- Verdeckte Kabel- bzw. Pneumatikschlauch-Durchführung
- Weitere Farben auf Anfrage

Innovative advantages

- Sealing profile surface
- Covered cable or pneumatic hose channel
- Other colours on request

Atouts novateurs

- Obturer la rainure
- Recouvrir les passages de câbles ou flexibles pneumatiques
- Autres coloris sur demande

Anwendungsbeispiele

Sample applications • Exemples d'application

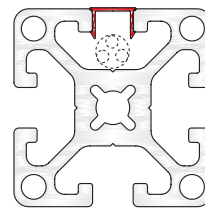
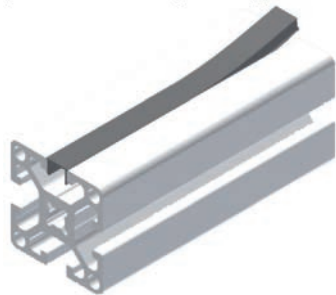

Kunststoff - Plastic - PVC

RAL

Profile	Material	Color	RAL	Price		
8E 8K 	PP	schwarz	black	noir	9011	05.02232.00
		lichtgrau	lightgrey	gris clair	7035	05.02233.00
		gelb	yellow	jaune	1018	05.02234.00
		alufarbig lackiert	alu color lapuered	aluminium-couleur laqué	9006	05.02233.10
8 	PP	schwarz	black	noir	9011	05.02235.00
		lichtgrau	lightgrey	gris clair	7035	05.02236.00
		alufarbig lackiert	alu color lapuered	aluminium-couleur laqué	9006	05.02236.10
10 	PVC	schwarz	black	noir	9011	05.01198.00
		lichtgrau	lightgrey	gris clair	7035	05.01698.00
		wasserblau	sea blue	bleu turquoise	5021	05.01197.10
	verkehrsblau	traffic blue	bleu	5017	05.01197.20	
	PP	alufarbig lackiert	alu color lapuered	aluminium-couleur laqué	9006	05.01698.10

Aluminium

8E 8K 	05.01964.00
8 10 	05.01965.00

Technische Änderungen vorbehalten

ABDECK- UND EINFASSPROFILE

MOUNTING RIM PROFILES

PROFILES DE RECOUVREMENT ET D'ENCADREMENT



Innovative Vorteile

- Schließen der Profilfläche
- Sicherer Halt für Flächenelemente

Innovative advantages

- Sealing the profile surfaces
- Secure hold for surface elements

Atouts novateurs

- Obturer la rainure
- Maintien sûr des éléments de remplissage

Anwendungsbeispiele

Sample applications • Exemples d'application

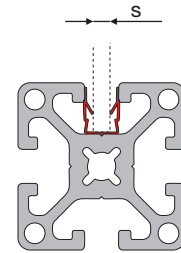
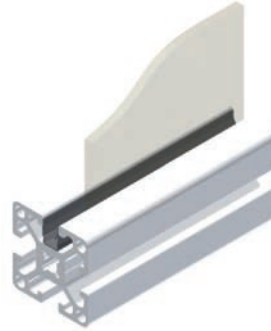
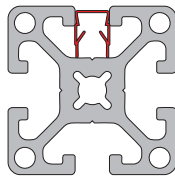

5		PP	schwarz	black	noir	9011	05.01847.00	
			natur	natural	naturel		05.01848.00	
8E		PP	schwarz	black	noir	9011	05.01836.00	
8K			natur	natural	naturel		05.01832.00	
		PP+TPE	schwarz	black	noir	9011	05.01859.00	
			natur	natural	naturel			
8		PP	schwarz	black	noir	9011	05.01837.00	
			natur	natural	naturel		05.01833.00	
			gelb	yellow	jaune	1023	05.01831.00	
		PP	natur	natural	naturel		05.01865.00	
10		PP+TPE	schwarz	black	noir	9011	05.01830.00	
			natur	natural	naturel			
		PE	schwarz	black	noir	9011	05.01187.00	
		PVC	grau	grey	gris		05.01049.00	

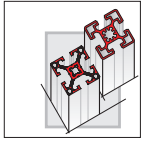

DICHTPROFILE SEALING PROFILE PROFILES D'ISOLEMENT



Innovative Vorteile

- Aufnahme von Scheiben und Flächenelementen
- Konstruktion von dichten Flächenelementen
- Einfache und schnelle Montage
- Material: TPE, schwarz
- 65 Shore
- PE: 50 m

Innovative advantages

- Locating panels and surface elements
- Construction of tight surface elements
- Quick and easy assembly
- Material: TPE, black
- 65 Shore
- PU (packing units): 50 m

Atouts novateurs

- Insertion de panneaux de remplissage
- Isolement d'éléments de remplissage
- Montage rapide et aisé
- Matière : TPE, noir
- 65 Shore
- Conditionnement : 50 m

Anwendungsbeispiele

Sample applications • Exemples d'application

8E

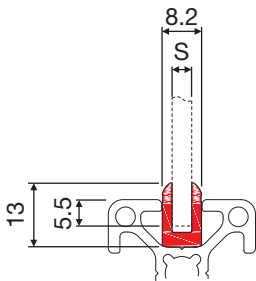

8

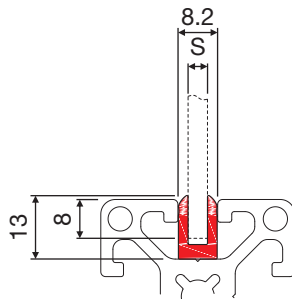

10

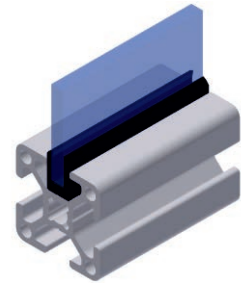
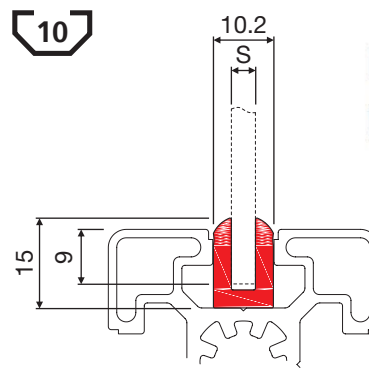

8E

8

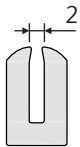

05.02067.00

10

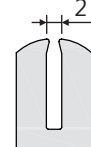

05.02070.00

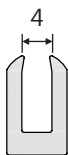

05.02068.00

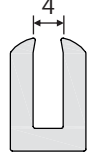

05.02071.00

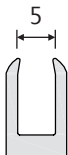

05.02069.00

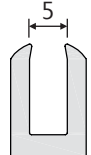

05.02072.00

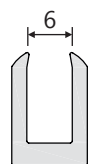

05.02075.00

DICHTPROFILE

SEALING PROFILES

PROFILES D'ISOLEMENT



Innovative Vorteile

- Verhindern das Austreten von Staub
- Für den Einsatz in Schwenktüren geeignet
- Einfache und schnelle Montage
- Material: NBR, schwarz 60 Shore
- PE: 50 m

Innovative advantages

- Prevents dust emerging
- Suitable for use in swivel doors
- Quick and easy assembly
- Material: NBR, black 60 shore hardness
- PU (packing units): 50 m

Atouts novateurs

- Etanchéité aux projections de Particules
- Adapté pour le montage de portes battantes
- Montage rapide et aisé
- Matière : NBR, noir 60 Shore
- Conditionnement : 50 m

Anwendungsbeispiele

Sample applications • Exemples d'application

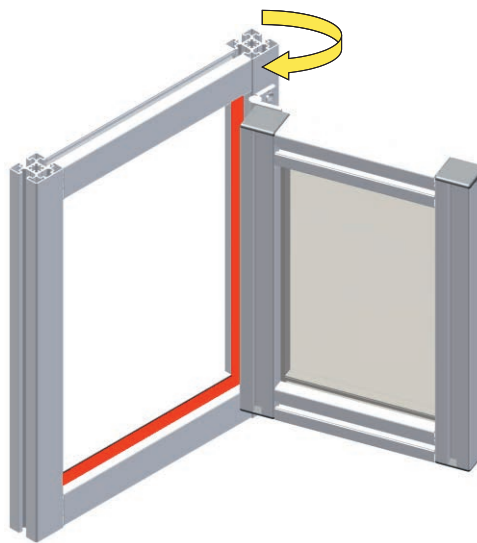

7

8E

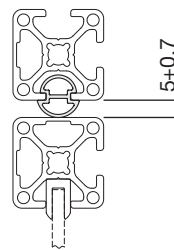

05.01850.00

10

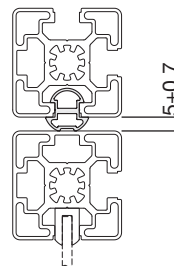

05.01851.00

Technische Änderungen vorbehalten

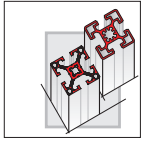

FLÄCHENELEMENTE SURFACE ELEMENTS ELEMENTS DE REMPLISSAGE



Dichtprofile

- Konstruktion von dichten Flächenelementen
- Einfache und schnelle Montage
- Material: TPE, schwarz 65 Shore
- PE: 50 m

Sealing profile

- Made of tight surface elements
- Quick and easy assembly
- Material: TPE, black 65 Shore
- PU (packing units): 50 m

Joint s étanches

- Construction d'éléments de remplissage étanches
- Montage rapide et aisé
- Matière : TPE, noir 65 Shore
- Conditionnement : 50 m

Anwendungsbeispiele

Sample applications • Exemples d'application

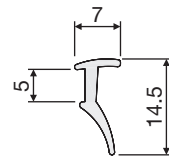
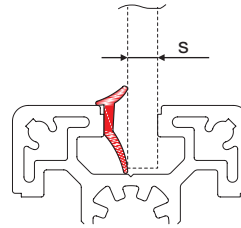
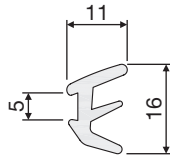
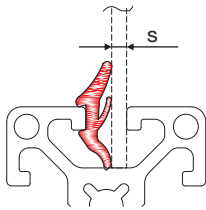

8E

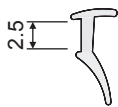

s = 2-4

05.01875.00

8

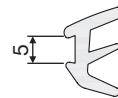

s = 2-4

05.02192.00

10

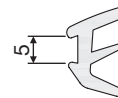

s = 4-6

05.02192.00

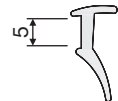

s = 4-6

05.02193.00

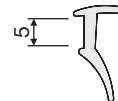

s = 6-8

05.02193.00

Abdeckprofil Riffelgummi

- Rutschsichere Auflage
- Schutz des Profils vor Beschädigung
- Material: NBR, schwarz 65 Shore
- PE: 20 m

Fluted rubber cover profile

- Non-slip cover
- Profile protection against damage
- Material: NBR, black 65 Shore
- PU (packing units): 20 m

Profils de protection caoutchouc cannelé

- Revêtement antidérapant
- Protection du profilé contre l'endommagement
- Matière : NBR, noir 65 Shore
- Conditionnement : 20 m

Anwendungsbeispiele

Sample applications • Exemples d'application

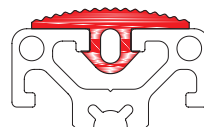
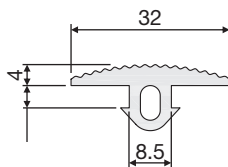

8

10



05.02194.00

WINKELLEISTE ANGLE RAILS CORNIERE A PANNEAUX

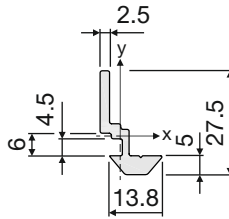
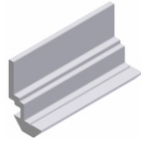

05.01874.00

M = 1,62 kg/m
 $I_x = 9,98 \text{ cm}^4$
 $W_x = 4,80 \text{ cm}^3$
 $I_y = 6,38 \text{ cm}^4$
 $W_y = 3,19 \text{ cm}^3$

PE (m)
 6 / 48 / 96 / 144

Varianten

Variants · Variantes

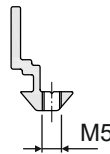
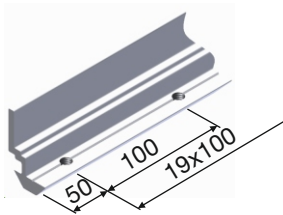

A

05.01874.50

Winkelleiste mit Gewindebohrungen

Angle rails with tapped holes

Profil support plateau avec taraudage

PE (m)
 1

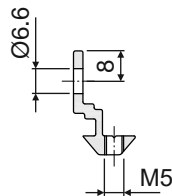
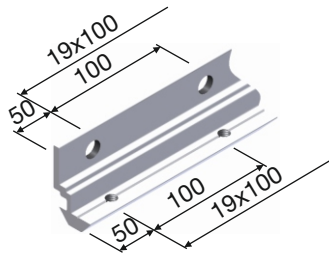

B

05.01874.51

Winkelleiste mit Gewinde- und Befestigungsbohrungen

Angle rails with tapped holes and fastening holes

Profil support plateau avec perçage et taraudage

PE (m)
 1



Anwendung

Application · Application

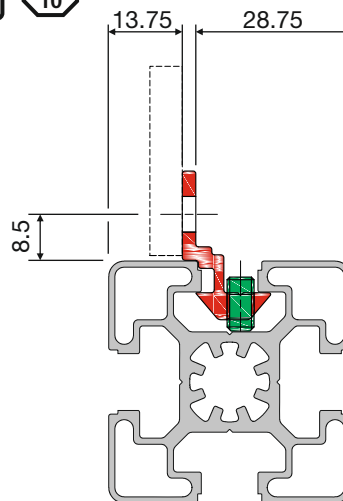
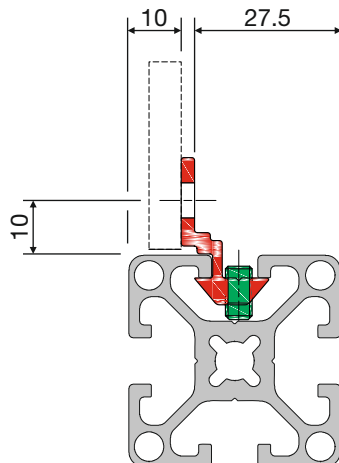

Befestigung mit Gewindestift
 DIN 913 - M5x10

Fastening with setscrew
 DIN 913 - M5x10

Fixation par vis sans tête
 DIN 913 - M5x10

Technische Änderungen vorbehalten

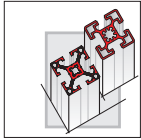

ANSCHRAUBHALTER SCREW-ON BRACKET EQUERRE A PANNEAUX



Innovative Vorteile

- Besonders geeignet für leichte Bleche, Acrylscheiben usw.
- Unterschiedliche Abstände zur Profilkante durch Einsatz von Zwischenplatten
- Material: PA, schwarz

Innovative advantages

- Particularly suitable for lightweight metal panels, acrylic plates etc.
- Alternative spacing to profile edge by using spacing plates
- Material: PA, black

Atouts novateurs

- Particulièrement adapté pour tôles légères, panneaux acryliques, etc.
- Calage différent par entretoises pour positionner le panneau
- Matière : PA, noir

5			05.01838.00	
8E			05.01314.00	
8			X = 8	05.01315.00
			X = 14	05.01318.00
10			05.01316.00	

Zwischenplatten

Spacing plates · Entretoises

5			a = 2	05.02195.00
			a = 3	05.02196.00
			a = 4	05.02197.00
8E			a = 2	05.01324.00
			a = 3	05.01317.00
			a = 5	05.01325.00

Technische Änderungen vorbehalten

KLEMMHALTER CLAMPS EQUERRE A PANNEAUX CRANTEE



Innovative Vorteile

- Besonders geeignet für leichte Bleche, Acrylscheiben usw.
- Unterschiedliche Abstände zur Profilkante durch Einsatz des Schiebers
- Material: PA, schwarz

Innovative advantages

- Particularly suitable for lightweight panels, acrylic plates etc.
- Alternative spacing to profile edge by using slider
- Material: PA, black

Atouts novateurs

- Particulièrement adapté pour tôles légères, panneaux acryliques, etc.
- Système de pincement mobile pour différentes épaisseurs de panneau
- Matière : PA, noir

Anwendungsbeispiele

Sample applications • Exemples d'application

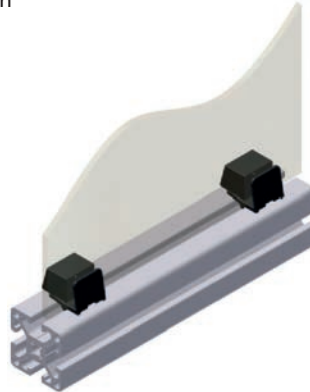

5					05.01839.00
8E					05.01319.00
8					A = 15; X = 5 05.01320.00 A = 8.5; X = 11.5 05.01321.00
10					05.01322.00

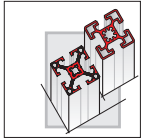

GITTEREINFASSPROFIL

MESH CLAMPING PROFILE

PROFIL D'ENCADREMENT



Innovative Vorteile

- Aufnahme von Wellgitter 30x30x3 und 40x40x4
- Besonders stabil durch tiefen Einschub
- Einfache und schnelle Montage

Innovative advantages

- Fastener for woven mesh 30x30x3 and 40x40x4
- Deep cavity for greater sturdiness
- Easy and fast assembly

Atouts novateurs

- Fixation de grillage ondulé 30x30x3 et 40x40x4
- Particulièrement robuste par introduction profonde
- Montage simple et rapide

A

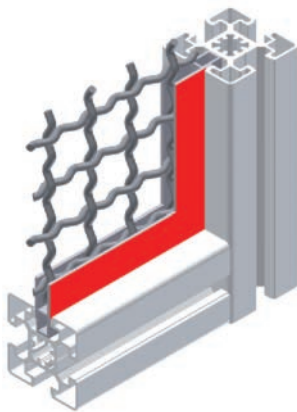

B

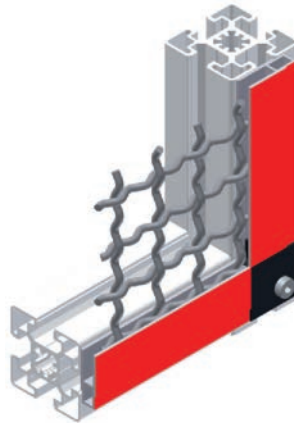

C

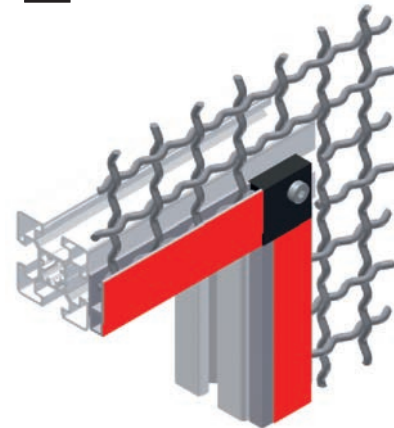

30x10

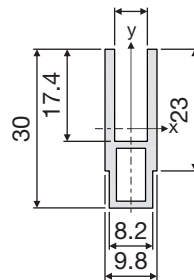

05.01117.00

M = 0.32 kg/m

PE (m)
6 / 30 / 60

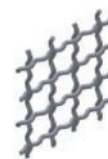

➔ 30x30x3

30x12

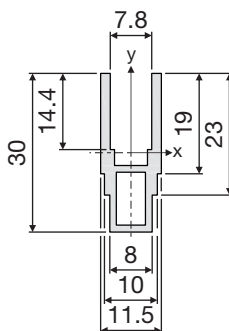

05.01118.00

M = 0.35 kg/m

Auf Anfrage
On Request
Sur demande

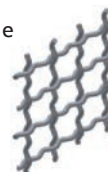



➔ 40x40x4

Technische Änderungen vorbehalten

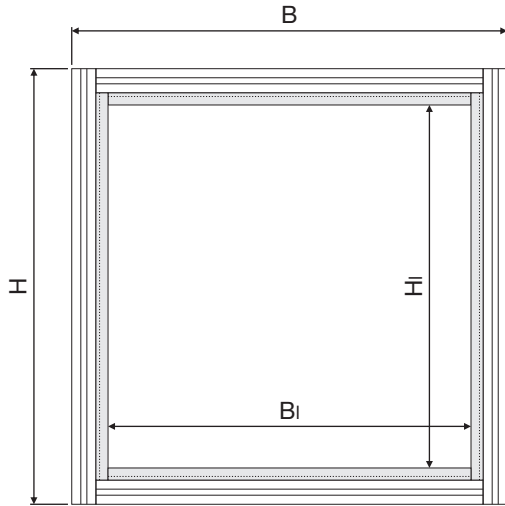
GITTEREINFASSPROFIL MESH CLAMPING PROFILE PROFIL D'ENCADREMENT



-  $B_i = B - 2 \times 63 \text{ mm}$ $H_i = H - 2 \times 63 \text{ mm}$
-  $B_i = B - 2 \times 62 \text{ mm}$ $H_i = H - 2 \times 62 \text{ mm}$

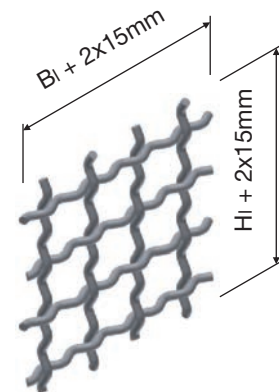

→ ■ 7.14

Eckelemente

Corner elements · Élément d'angle

→ ■ B

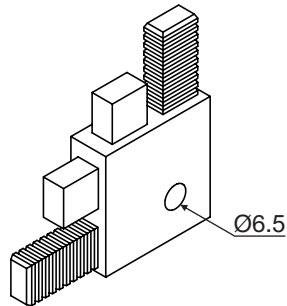

05.01146.00

- NBR, schwarz
60 Shore
- NBR, black
60 Shore
- NBR, noir
60 Shore

→ ■ C

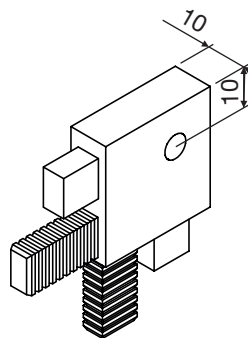

05.01147.00

- NBR, schwarz
60 Shore
- NBR, black
60 Shore
- NBR, noir
60 Shore

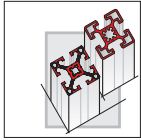

FLÄCHENELEMENTE SURFACE ELEMENTS REMPLISSAGE



Geschlossene Flächenelemente

Closed surface elements

Panneaux de remplissage fermé

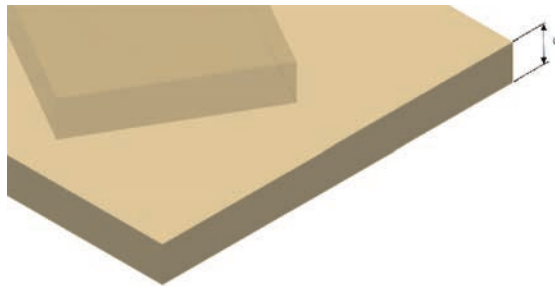

Polycarbonat

- Markenname: Makrolon
- Gute Schlagfestigkeit und Zähigkeit
- Sehr gute optische Eigenschaften
- 1mm: $m = 1.2 \text{ kg/m}^2$
- Klar oder rauchfarben getönt
- Maße auf Anfrage
 $s = 2, 3, 4, 5, 6, 8, 10, 12 \text{ mm}$

Polycarbonate

- Brand name: Makrolon
- Good impact resistance and resilience
- Very good optical properties
- 1mm: $m = 1.2 \text{ kg/m}^2$
- Transparent or smoke-tinted
- Dimensions on request
 $s = 2, 3, 4, 5, 6, 8, 10, 12 \text{ mm}$

Polycarbonate

- Type : Makrolon
- Bonne endurance et résistance aux chocs
- Très bonnes propriétés optiques
- 1mm : $m = 1.2 \text{ kg/m}^2$
- Transparent ou fumé
- Dimensions sur demande
 $s = 2, 3, 4, 5, 6, 8, 10, 12 \text{ mm}$

PMMA

- Markenname: Plexiglas
- Gute chemische Beständigkeit
- 1mm: $m = 1.18 \text{ kg/m}^2$
- Klar oder rauchfarben getönt
- Maße auf Anfrage
 $s = 2, 3, 4, 5, 6, 8, 10, 12 \text{ mm}$

PMMA

- Brand name: Plexiglas
- Good chemical resistance
- 1mm: $m = 1.18 \text{ kg/m}^2$
- Transparent or smoke-tinted
- Dimensions on request
 $s = 2, 3, 4, 5, 6, 8, 10, 12 \text{ mm}$

PMMA

- Type : Plexiglas
- Bonne résistance chimique
- 1mm : $m = 1.18 \text{ kg/m}^2$
- Transparent ou fumé
- Dimensions sur demande
 $s = 2, 3, 4, 5, 6, 8, 10, 12 \text{ mm}$

Vollkunststoff

- Hohe Abrieb- und Schlagfestigkeit
- Geeignet für hochbeanspruchte Verkleidungen
- Hohe Temperaturbeständigkeit
- 1mm: $m = 1.4 \text{ kg/m}^2$
- Farben ähnlich RAL auf Anfrage
4 mm nur ähnlich RAL 7035
- Maße auf Anfrage
 $s = 4, 6, 8 \text{ mm}$

Full plastic

- Highly resistant to abrasion and knocks
- Suitable for highly stressed panelling
- Highly temperature resistance
- 1mm: $m = 1.4 \text{ kg/m}^2$
- RAL-similar colours on request
4 mm only similar to RAL 7035
- Dimensions on request
 $s = 4, 6, 8 \text{ mm}$

Tout plastique

- Haute résistance à l'usure et aux chocs
- Adapté pour revêtements fortement sollicités
- Haute résistance thermique
- 1mm : $m = 1.4 \text{ kg/m}^2$
- Couleurs similaires RAL sur demande
4 mm seulement similaire à RAL 7035
- Dimensions sur demande
 $s = 4, 6, 8 \text{ mm}$

Hartfaserplatte

- Farbe: weiß
- Maße auf Anfrage
 $s = 4, 5 \text{ mm}$

Hardboard

- Colour: white
- Dimensions on request
 $s = 4, 5 \text{ mm}$

Panneau de fibres

- Couleur : blanc
- Dimensions sur demande
 $s = 4, 5 \text{ mm}$

FOREX-Platten

- Farbe: weiß / RAL-Farben auf Anfrage
- Maße auf Anfrage
 $s = 3, 4, 5, 6, 8 \text{ mm}$

FOREX-board

- Colour: white / RAL-similar colours on request
- Dimensions on request
 $s = 3, 4, 5, 6, 8 \text{ mm}$

Panneau FOREX

- Couleur : blanc / couleurs similaires RAL sur demande
- Dimensions sur demande
 $s = 3, 4, 5, 6, 8 \text{ mm}$

FLÄCHENELEMENTE SURFACE ELEMENTS REEMPLISSAGE



Spanplatte

- Preiswertes Flächenelement
- Mittlere mechanische Eigenschaften
- Farben: weiß, lichtgrau (RAL 7035)
- Maße auf Anfrage
s = 6, 8 mm

Chipboard

- Economical surface element
- Mean mechanical properties
- Colours: white, light grey (RAL 7035)
- Dimensions on request
s = 6, 8 mm

Panneaux d'agglomérés

- Élément de remplissage économique
- Propriétés mécaniques moyennes
- Couleurs : blanc, gris clair (RAL 7035)
- Dimensions sur demande
s = 6, 8 mm

Blech

- Werkstoff: Aluminium, Stahl, VA
- Oberflächen: blank, eloxiert oder beschichtet
- 1mm (Al): m = 2.7 kg/m²
- 1mm (St): m = 7.9 kg/m²
- 1mm (VA): m = 8.0 kg/m²
- Farben nach RAL auf Anfrage
- Maße auf Anfrage
s = 2, 3 mm

Metal sheet

- Material: Aluminium, steel, VA
- Surfaces: natural finish, anodised or coated
- 1mm (Al): m = 2.7 kg/m²
- 1mm (St): m = 7.9 kg/m²
- 1mm (VA): m = 8.0 kg/m²
- RAL colours on request
- Dimensions on request
s = 2, 3 mm

Tôle

- Matière : aluminium, acier, inox
- Surfaces : naturelle, anodisée ou enduite
- 1mm (Al) : m = 2.7 kg/m²
- 1mm (St) : m = 7.9 kg/m²
- 1mm (VA) : m = 8.0 kg/m²
- Couleurs selon RAL sur demande
- Dimensions sur demande
s = 2, 3 mm

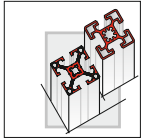

FLÄCHENELEMENTE SURFACE ELEMENTS REMPLISSAGE



Wellgitter

- Hohe Festigkeit des Stahldrahtes
- Geeignet für beanspruchte Sicherheitseinrichtungen
- Bieten Schutz vor Durchgreifen bzw. großen Teilen
- Oberfläche: verzinkt oder beschichtet
- Farben: schwarz; weitere Farben auf Anfrage

Woven mesh

- High-strength steel wire
- Suitable for highly stressed safety installations
- Only offers protection against reaching in or for large parts
- Surface: galvanised or coated
- Colour: black, other colours on request

Grille ondulée

- Résistance élevée du fil d'acier
- Adapté pour installations de sécurité fortement sollicitées
- Ne protège que contre l'intrusion ou contre les grandes pièces
- Surface : zinguée ou enduite
- Couleurs : noir, autres couleurs sur demande

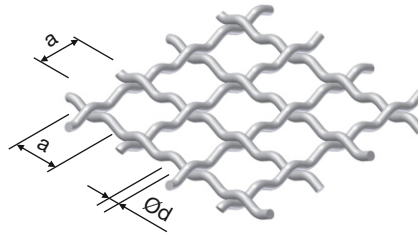

Wellgitter 30

- $a \times a \times \text{Ø}d$
30 x 30 x 3
- $m = 3.69 \text{ kg/m}^2$

- Maße auf Anfrage

Woven mesh 30

- $a \times a \times \text{Ø}d$
30 x 30 x 3
- $m = 3.69 \text{ kg/m}^2$

- Dimensions on request

Grille ondulée 30

- $a \times a \times \text{Ø}d$
30 x 30 x 3
- $m = 3.69 \text{ kg/m}^2$

- Dimensions sur demande

Wellgitter 40

- $a \times a \times \text{Ø}d$
40 x 40 x 4
- $m = 4.92 \text{ kg/m}^2$

- Maße auf Anfrage

Woven mesh 40

- $a \times a \times \text{Ø}d$
40 x 40 x 4
- $m = 4.92 \text{ kg/m}^2$

- Dimensions on request

Grille ondulée 40

- $a \times a \times \text{Ø}d$
40 x 40 x 4
- $m = 4.92 \text{ kg/m}^2$

- Dimensions sur demande

TÜREN UND TÜRELEMENTE

DOORS AND DOOR ELEMENTS

PORTES ET ACCESSOIRES



■ 8.02

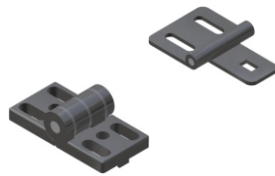

■ 8.04



■ 8.08

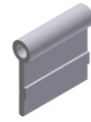

■ 8.10



■ 8.12



■ 8.13



■ 8.14

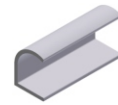

■ 8.15



■ 8.16

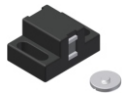

■ 8.19

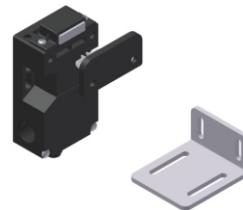

■ 8.20

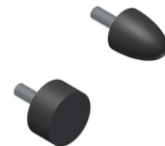

■ 8.21



■ 8.22

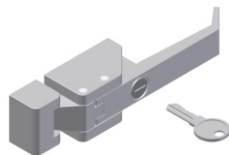

■ 8.23



■ 8.24



■ 8.25

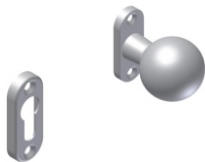

■ 8.26



■ 8.28

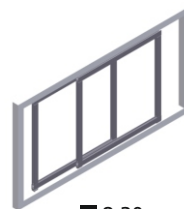

■ 8.30



■ 8.32

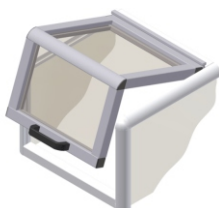

■ 8.34



■ 8.34



■ 8.35



■ 8.36

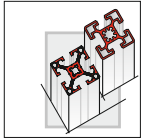

SCHARNIERE
HINGES
CHARNIERES



20x20



PA schwarz
black
noir

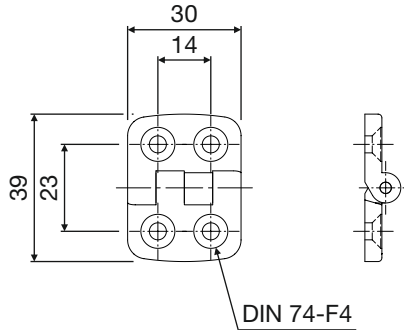

20 / 20

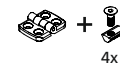
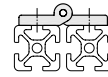

05.01300.05

4x

32x60



PA schwarz
black
noir

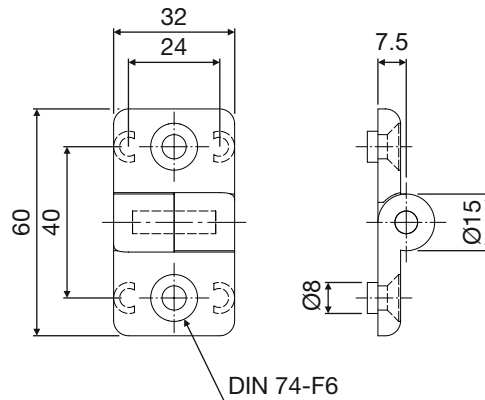

40 / 40

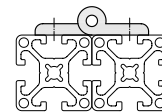

05.01630.05

2x



05.01629.05

2x

Aushängbare Tür
LINKS / LINKS
Demountable doors
LEFT / LEFT
Porte dégonnable
GAUCHE / GAUCHE

Aushängbare Tür
RECHTS / RECHTS
Demountable door
RIGHT / RIGHT
Porte dégonnable
DROITE / DROITE

Nicht aushängbare Tür
LINKS / RECHTS
Non-demountable doors
LEFT / RIGHT
Porte non dégonnable
GAUCHE / DROITE

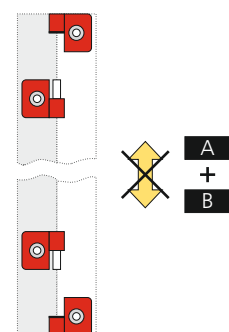
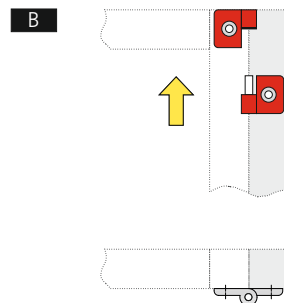
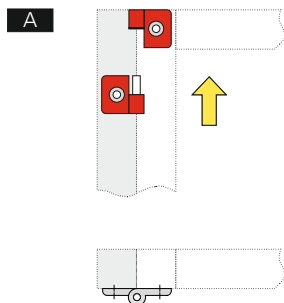

Technische Änderungen vorbehalten

DOPPELSCHARNIER
DOUBLE HINGES
DOUBLE CHARNIERE

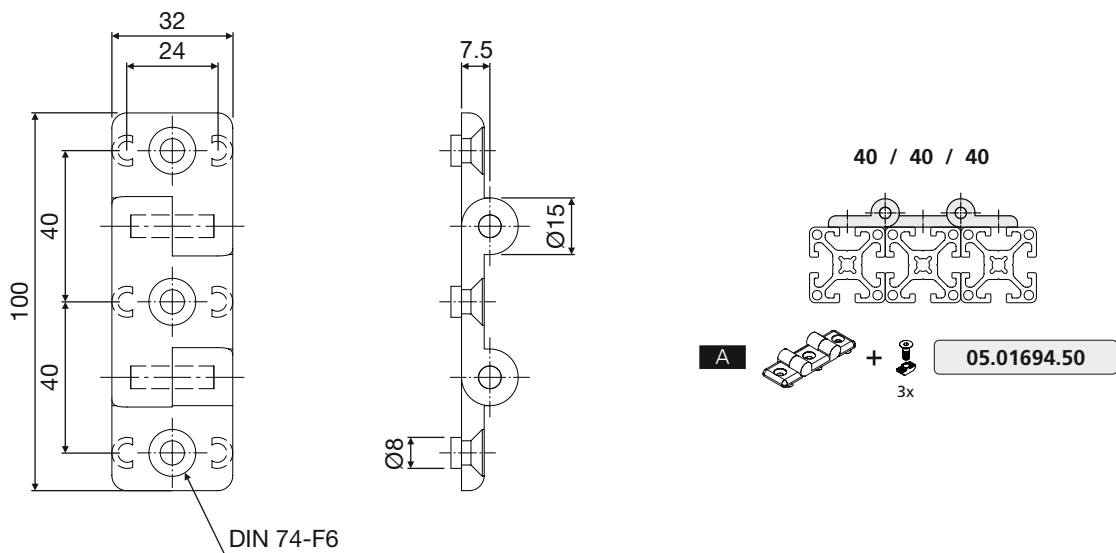
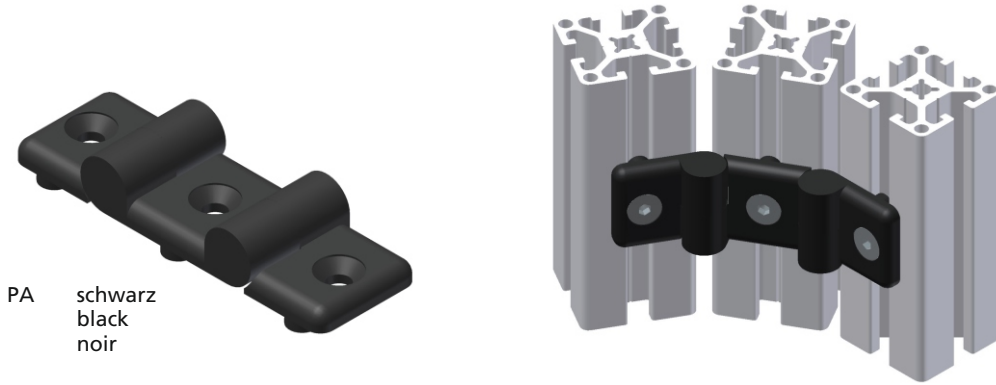

Aushängbare Türen
 Demountable doors
 Portes dégonçables

Nicht aushängbare Türen
 (180° gedreht)
 Non-demountable doors
 (turned through 180°)
 Portes non dégonçables
 (tournées sur 180°)

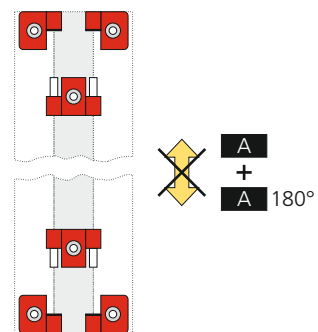
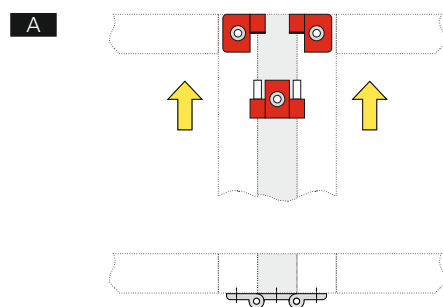

Technische Änderungen vorbehalten

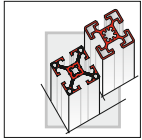

SCHARNIERE
HINGES
CHARNIERES



40 Zn, symmetrisch

40 Zn, symmetric · 40 Zn, symétrique

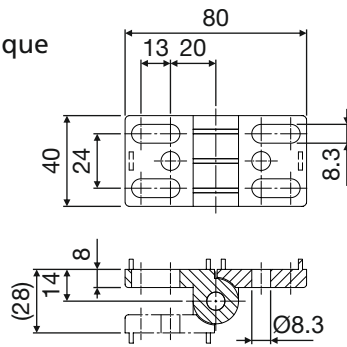
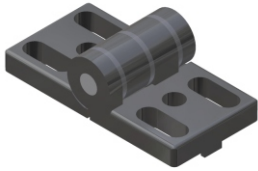

05.01639.00

Zinkdruckguss, schwarz
Zinc diecast, black
Zamak, noir

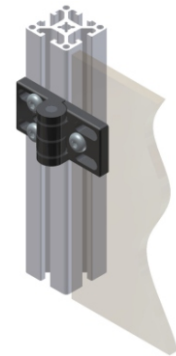
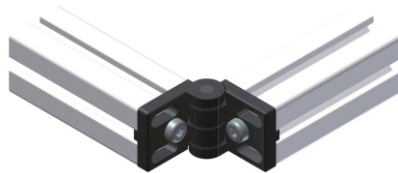
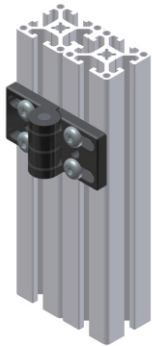

Blechscharnier

Sheet metal hinge · Charnière en tôle

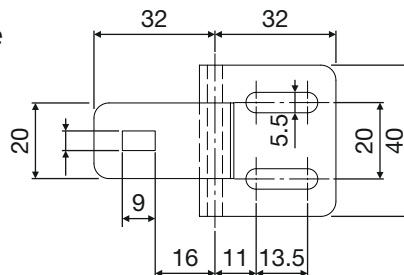

05.01119.00

Stahl, schwarz beschichtet
Steel, black coated
Acier, noire pelliculé

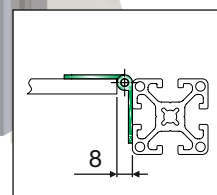
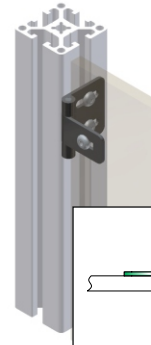
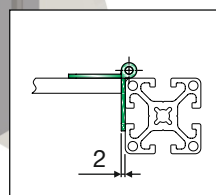
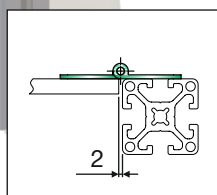
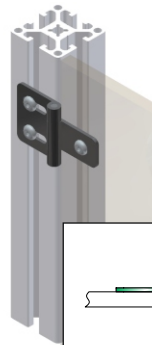
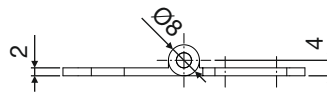

Technische Änderungen vorbehalten

SCHARNIERE HINGES CHARNIERES



45, symmetrisch

45, symmetric · 45, symétrique

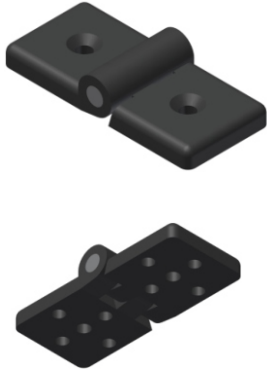

PA6, schwarz
PA6, black
PA6, noir

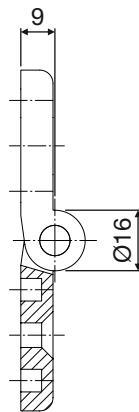
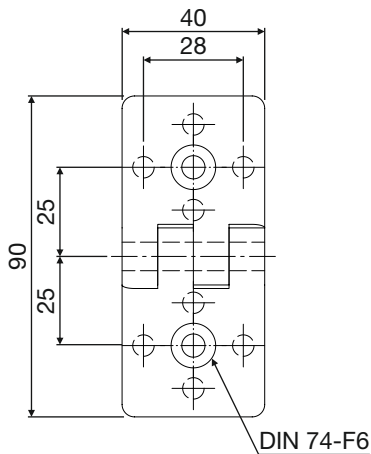

05.01303.00

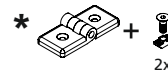

05.01303.xx

2x

*Mit Befestigung

*With adapter kit · *Avec kit de montage

30 - 45

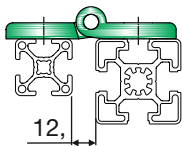

05.01303.11

30 - 60

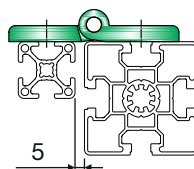

05.01303.11

40 - 40

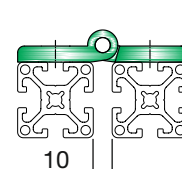

05.01303.12

40 - 45

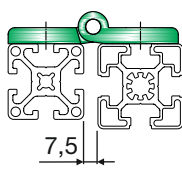

05.01303.13

40 - 60

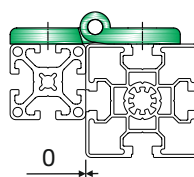

05.01303.13

45 - 45

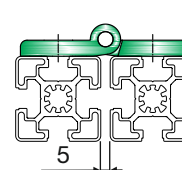

05.01303.14

Technische Änderungen vorbehalten

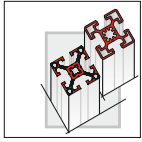

KUNSTSTOFF-SCHARNIER-SYSTEM
PLASTIC HINGE SYSTEM
CHARNIERE DE SYSTEME POLYAMIDE

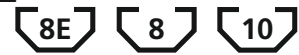

PA schwarz
 black
 noir

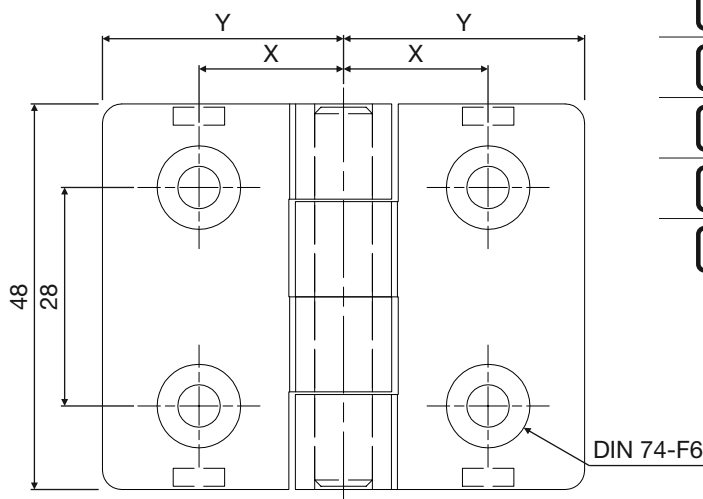
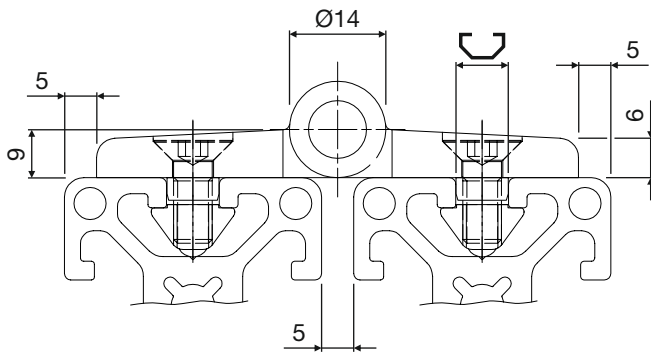
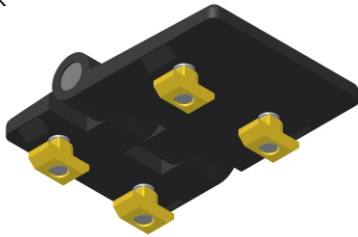

		X	Y
		17.5	27.5
		22.5	37.5
		25	42.5
		27.5	47.5
		32.5	57.5

Technische Änderungen vorbehalten

KUNSTSTOFF-SCHARNIER-SYSTEM

PLASTIC HINGE SYSTEM

CHARNIERE DE SYSTEME POLYAMIDE

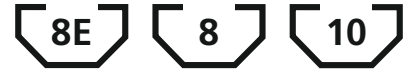

30

40

30 / 30

40 / 40

30 / 40

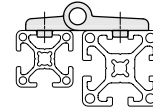
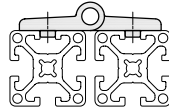
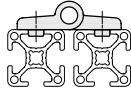

05.02301.00

05.02303.00

05.02302.00

45

45 / 45

40 / 45

30 / 45

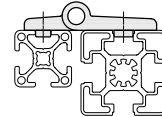
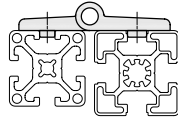
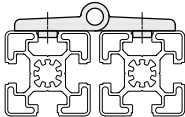

05.02306.00

05.02305.00

05.02304.00

50

50 / 50

45 / 50

40 / 50

30 / 50

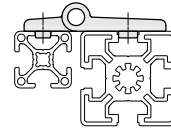
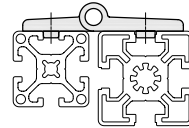
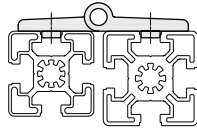
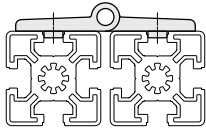

05.02310.00

05.02309.00

05.02308.00

05.02307.00

60

60 / 60

50 / 60

45 / 60

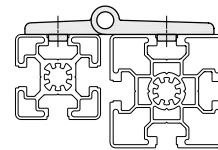
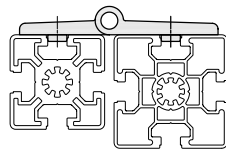
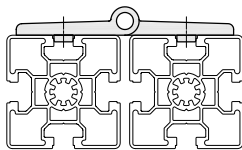

05.02315.00

05.02314.00

05.02313.00

40 / 60

30 / 60

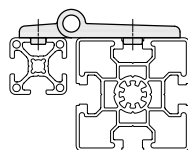
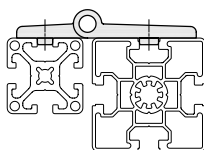

05.02312.00

05.02311.00



05.0xxxx.00

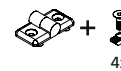

05.0xxxx.05

Technische Änderungen vorbehalten

8

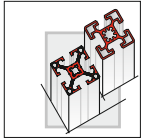

ALU-SCHARNIER-SYSTEM

ALUMINIUM HINGE SYSTEM

SYSTEME DE CHARNIERES ALU



Innovative Vorteile

- Kräftige und robuste Ausführung aus Strangpressprofil
- Leichtgängige Drehbewegung durch Gleitbuchsen
- Werkstoff: AlMgSi0,5
- Farbe: Natur eloxiert

Innovative advantages

- Sturdy and rugged design made of extruded profile
- Slide bushing for easy running rotational movement
- Materials: AlMgSi0,5
- Colour: Natural-coloured aluminium, anodized

Atouts novateurs

- Modèle robuste en profilé extrudé
- Rotation aisée par douilles de glissement
- Matière : AlMgSi0,5
- Couleur : Aluminium anodisé naturelle

Befestigungssatz bestehend aus:

- ISO 10642 M6
- Fixierbolzen
- Hammermutter M6

Fastening set consisting of:

- ISO 10642 M6
- Fastening bolts
- Hammer nut M6

Kit de fixation comprenant :

- ISO 10642 M6
- Boulon de fixation
- Ecrou 1/4 de tour M6

L=60

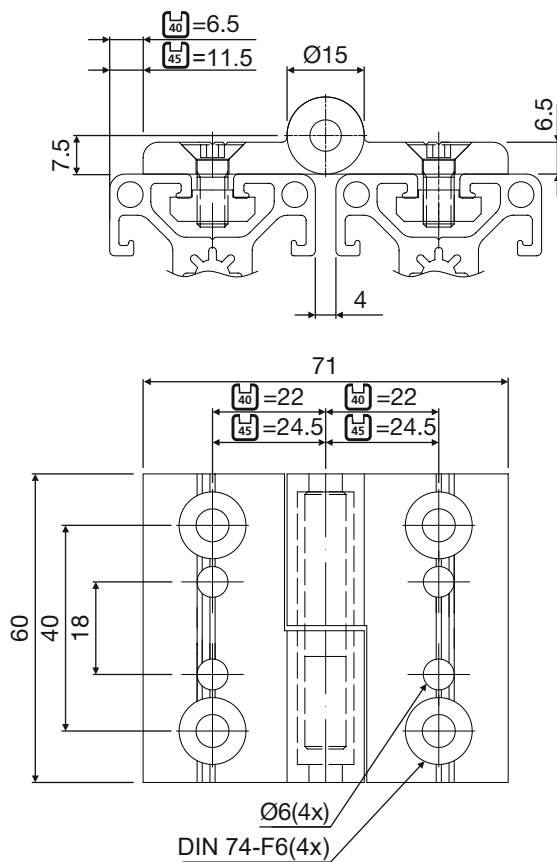

L=80

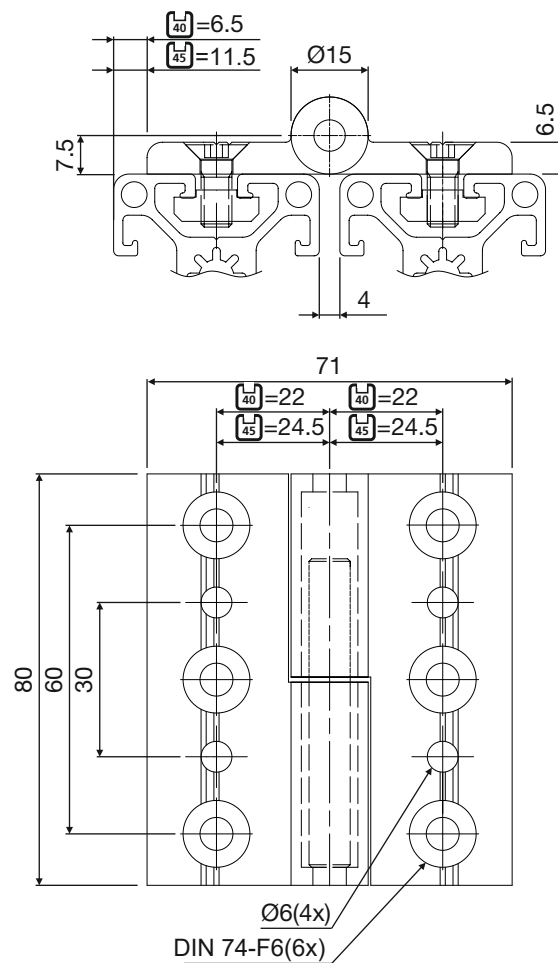
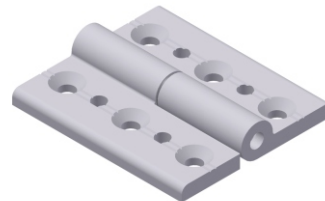

Technische Änderungen vorbehalten

ALU-SCHARNIER-SYSTEM

ALUMINIUM HINGE SYSTEM

SYSTEME DE CHARNIERES ALU



L=60

L=80

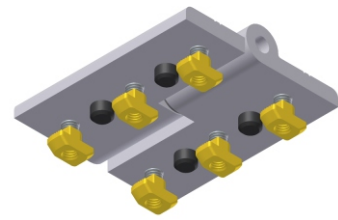
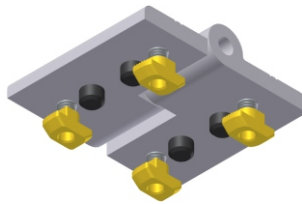
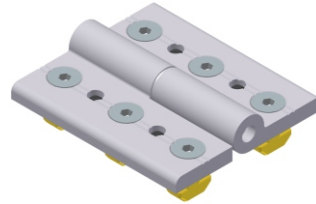
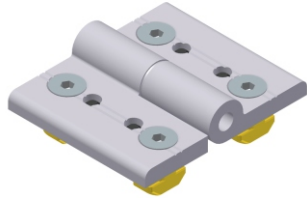

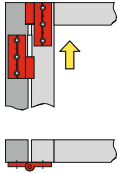
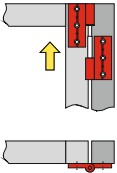
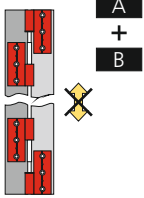
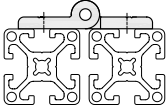
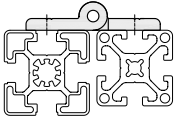
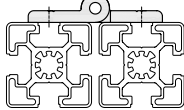
	A	B	C
	<p>Aushängbare Tür LINKS / LINKS Demountable door LEFT / LEFT Porte dégonnable GAUCHE / GAUCHE</p>  <p style="text-align: center;">L</p>	<p>Aushängbare Tür RECHTS / RECHTS Demountable door RIGHT / RIGHT Porte dégonnable DROITE / DROITE</p>  <p style="text-align: center;">L</p>	<p>Nicht aushängbare Tür, LINKS / RECHTS Non-demountable door LEFT / RIGHT Porte non dégonnable GAUCHE / DROITE</p>  <p style="text-align: center;">L</p>
40 - 40 	<p>60 <input type="text" value="05.01732.00"/></p> <p>80 <input type="text" value="05.01634.00"/></p> <p>inkl. Bef.satz <input type="text" value="xx.xxxxx.05"/></p>	<p>60 <input type="text" value="05.01733.00"/></p> <p>80 <input type="text" value="05.01632.00"/></p> <p>inkl. Bef.satz <input type="text" value="xx.xxxxx.05"/></p>	C = 1x A + 1x B
45 - 40 	<p>60 <input type="text" value="05.02152.00"/></p> <p>80 <input type="text" value="05.02154.00"/></p> <p>inkl. Bef.satz <input type="text" value="xx.xxxxx.05"/></p>	<p>60 <input type="text" value="05.02153.00"/></p> <p>80 <input type="text" value="05.02155.00"/></p> <p>inkl. Bef.satz <input type="text" value="xx.xxxxx.05"/></p>	C = 1x A + 1x B
45 - 45 	<p>60 <input type="text" value="05.02056.00"/></p> <p>80 <input type="text" value="05.02108.00"/></p> <p>inkl. Bef.satz <input type="text" value="xx.xxxxx.05"/></p>	<p>60 <input type="text" value="05.02057.00"/></p> <p>80 <input type="text" value="05.02109.00"/></p> <p>inkl. Bef.satz <input type="text" value="xx.xxxxx.05"/></p>	C = 1x A + 1x B

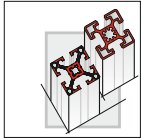

SCHARNIERLAPPENPROFILE

HINGE FLAP PROFILES

CHARNIERES INTERIEURES



8E

8

10

Typ A

A Einzelscharnier
Single hinge
Charnière individuelle

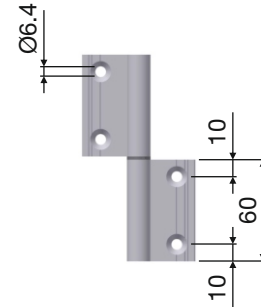
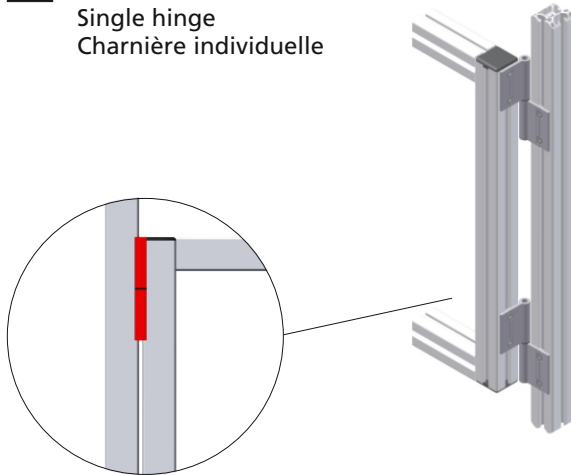

Typ B

B Durchgehendes Scharnier
Continuous hinge
Charnière monobloc

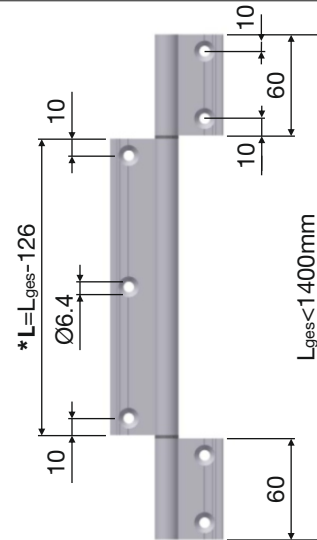
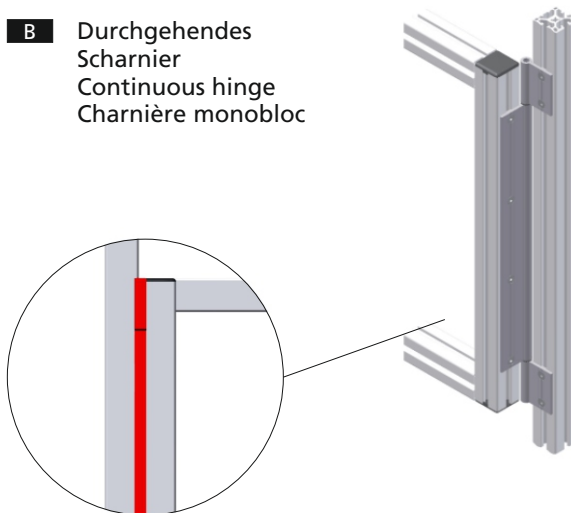

Typ C

C Unterbrochenes Scharnier
Interrupted hinge
Charnière monobloc discontinue

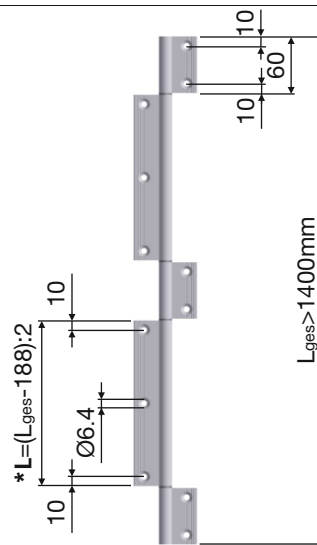
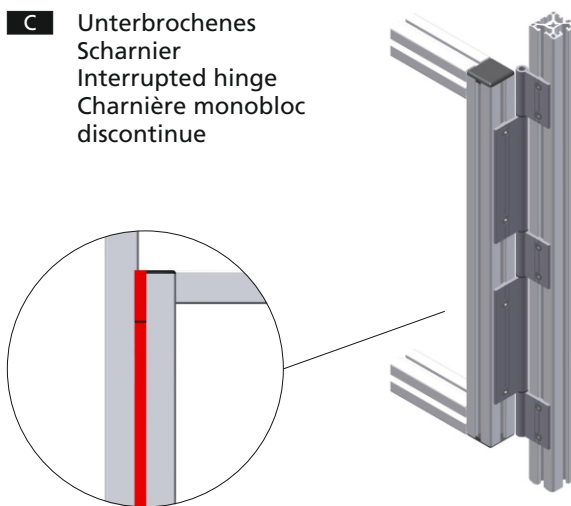

Technische Änderungen vorbehalten

SCHARNIERLAPPENPROFILE

HINGE FLAP PROFILES

CHARNIERE INTERIEURES

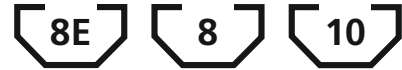

30

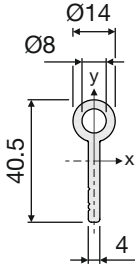

05.01807.00

M = 0.55 kg/m
 $I_x = 3.04 \text{ cm}^4$
 $W_x = 1.50 \text{ cm}^3$
 $I_y = 0.18 \text{ cm}^4$
 $W_y = 0.26 \text{ cm}^3$

PE (m)
 3

Aluminium, eloxiert
 Aluminium, anodized
 Aluminium, anodisé

40/45

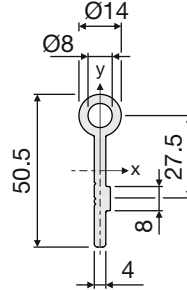

05.02231.00

M = 0.68 kg/m
 $I_x = 5.92 \text{ cm}^4$
 $W_x = 2.35 \text{ cm}^3$
 $I_y = 0.19 \text{ cm}^4$
 $W_y = 0.28 \text{ cm}^3$

PE (m)
 6 / 60 / 120

Aluminium, eloxiert
 Aluminium, anodized
 Aluminium, anodisé

Kunststoffring Ø14
 t= 1 mm, PA 6.6

05.01876.00

Steckerstift 8x80

05.01878.00

30

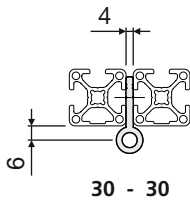

A 05.02283.05

B 05.02284.05

+ 1x 05.01807.50 *L= mm

C 05.02285.05

+ 2x 05.01807.50 *L= mm

40

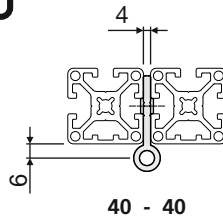

A 05.02286.05

B 05.02287.05

+ 1x 05.02231.50 *L= mm

C 05.02288.05

+ 2x 05.02231.50 *L= mm

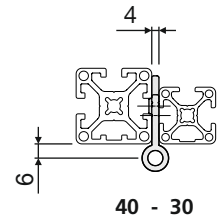

A 05.02289.05

B 05.02290.05

+ 1x 05.01807.50 *L= mm

C 05.02291.05

+ 2x 05.01807.50 *L= mm

45

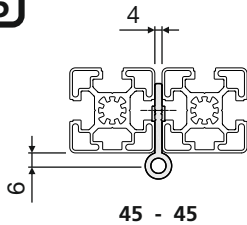

A 05.02292.05

B 05.02293.05

+ 1x 05.02231.51 *L= mm

C 05.02294.05

+ 2x 05.02231.51 *L= mm

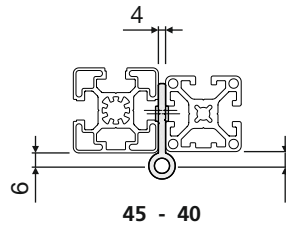

A 05.02295.05

B 05.02296.05

+ 1x 05.02231.51 *L= mm

C 05.02297.05

+ 2x 05.02231.51 *L= mm

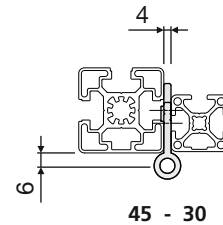

A 05.02298.05

B 05.02299.05

+ 1x 05.02231.51 *L= mm

C 05.02300.05

+ 2x 05.02231.51 *L= mm

8

Technische Änderungen vorbehalten

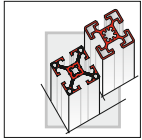

BÜGELGRIFFE
BOW HANDLES
POIGNEES ETRIER



L=121

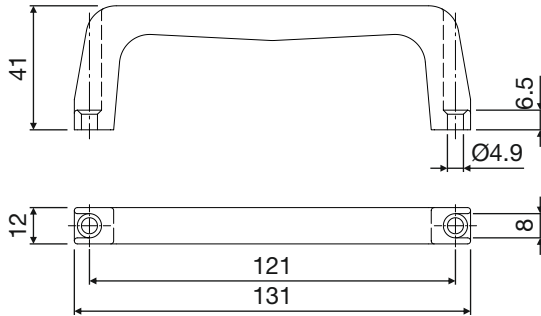

PA 6
 schwarz
 black
 noire



05.01665.00

L=122/L=150

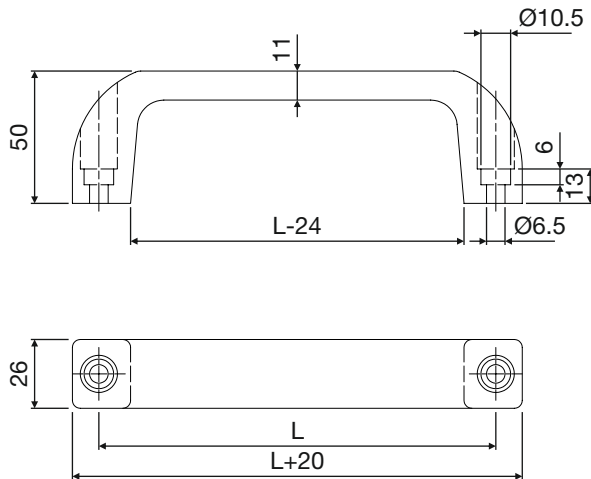

PA 6
 schwarz
 black
 noire

L=122

		+		05.01223.00
		+		05.01223.13
		+		05.01223.11
		+		05.01223.12

2x

L=150

		+		05.01224.00
		+		05.01224.13
		+		05.01224.11
		+		05.01224.12

2x

Technische Änderungen vorbehalten

BÜGELGRIFFE

BOW HANDLES

POIGNEES ETRIER



Typ A

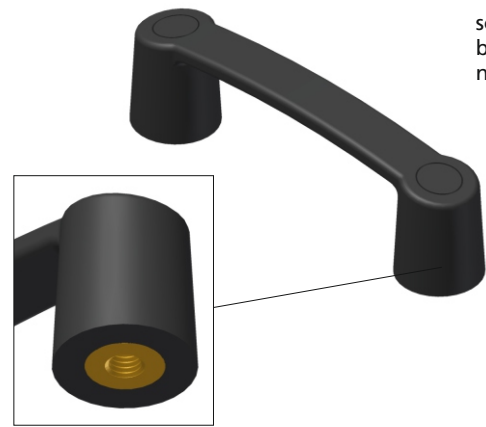
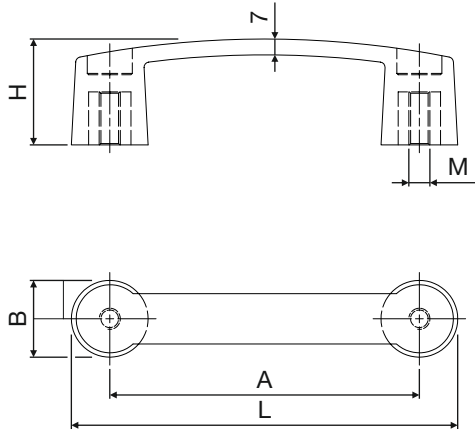

PA 6
schwarz
black
noire

L	A	B	H	M	
120	94	26	35	M6	05.01667.00
145	117	29	40	M8	05.01668.00
163	132	31	45	M8	05.01669.00
213	180	35	50	M8	05.01670.00

Typ B

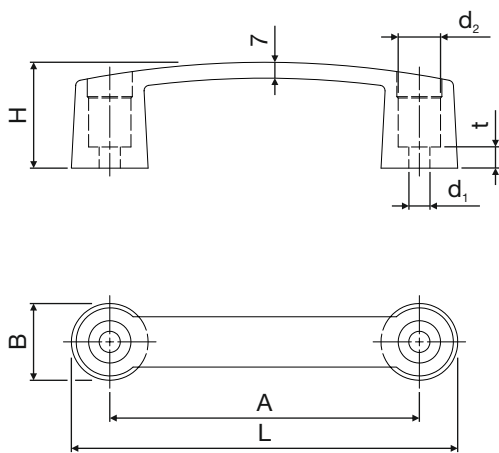

PA 6
schwarz
black
noire

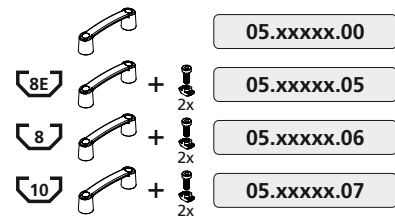

L	A	B	H	d ₁	d ₂	t	
120	94	26	35	Ø6.5	Ø12.5	4	05.01671.xx
145	117	29	40	Ø8.5	Ø16.5	8	05.01672.xx
163	132	31	45	Ø8.5	Ø16.5	9	05.01673.xx
213	180	35	50	Ø8.5	Ø16.5	12	05.01674.xx



Technische Änderungen vorbehalten

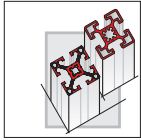

HANDGRIFF VARIABLE GRIFFLÄNGEN
HANDLES VARIABLE HANDLE LENGTH
POIGNEE TUBULAIRE VARIABLE



8E

8

10

Typ A

05.01326.00

Typ B

05.01327.00

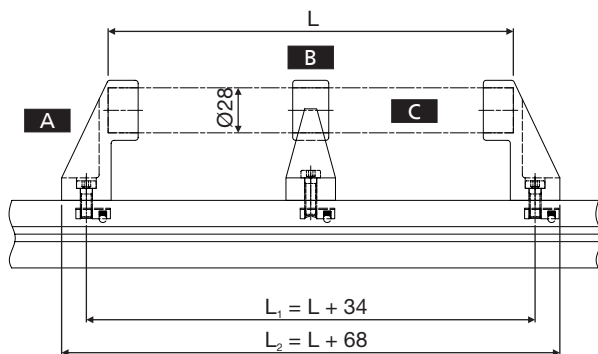

C L = 266 mm 05.01328.01

L = 366 mm 05.01328.02

L = 466 mm 05.01328.03

L = 566 mm 05.01328.04

L = 666 mm 05.01328.05

L = 766 mm 05.01328.06

L = 2500 mm 05.01328.07

Ausführung:

- A** Griff: Endstück
Werkstoff: PA
Farbe: Schwarz
- B** Griff: Mittenstück
Werkstück: PA
Farbe: Schwarz

Zu empfehlen ab
L=566 mm
- C** Stahlrohr
Werkstoff: PVC ummantelt
Farbe: Schwarz

Design:

- A** Handle: End piece
Material: PA
Colour: Black
- B** Handle: Centre piece
Material: PA
Colour: Black

Recommended as of
L= 566 mm
- C** Steel pipe
Material: PVC sheathed
Colour: Black

Versions:

- A** Poignée : Extrémité
Matière : PA
Couleur : Noir
- B** Poignée : Pièce de centre
Matière : PA
Couleur : Noir

Recommandé à partir
L= 566 mm
- C** Tube acier
Matière : PVC gainé
Couleur : Noir

Technische Änderungen vorbehalten

GRIFFPROFIL HANDLE PROFILE PROFILE POIGNEE



Griffprofil

Handle profile · Profilé poignée

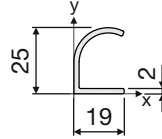
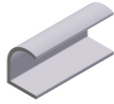

05.01032.00

M = 0.29 kg/m
 $I_x = 2.28 \text{ cm}^4$
 $W_x = 1.82 \text{ cm}^3$
 $I_y = 0.91 \text{ cm}^4$
 $W_y = 0.47 \text{ cm}^3$

PE (m)
6 / 24 / 48 / 72

Anwendung

Application · Application

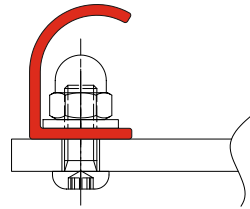
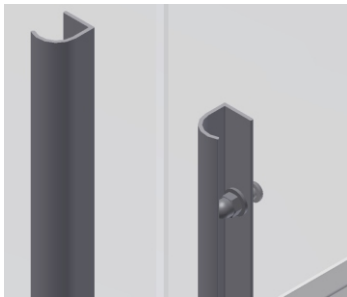

8

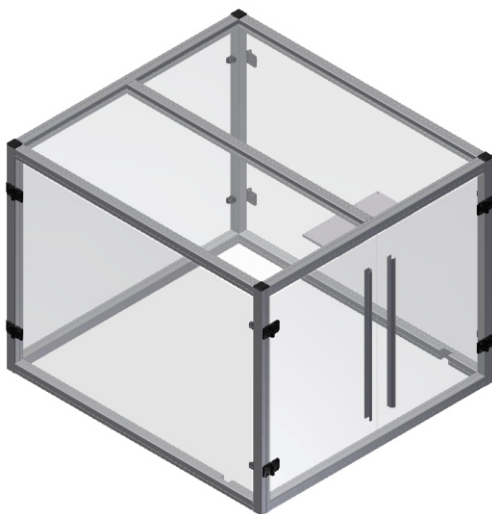

Technische Änderungen vorbehalten

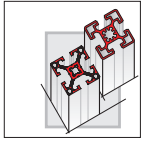

KUGELSCHNÄPPER

BALL CLIPS

TAQUET A BILLE

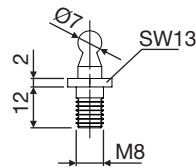
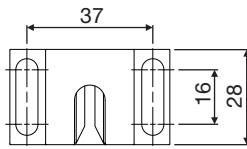
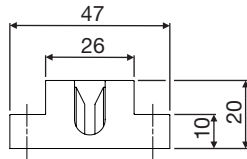
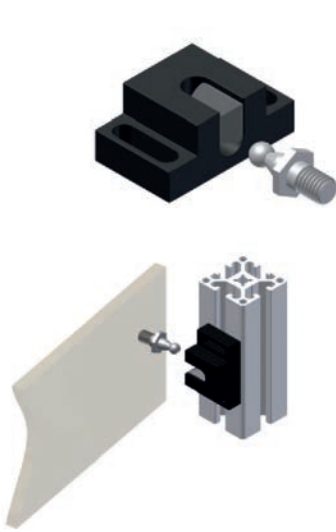

05.02316.00

PA schwarz, glasfaserverstärkt,
Verschluss von Schiebe- und
Schwenktüren

PA black, fibreglass reinforced,
Closure of sliding and swing
doors

PA noir, renforcé fibres de verre
Fermeture de portes
coulissantes et battantes

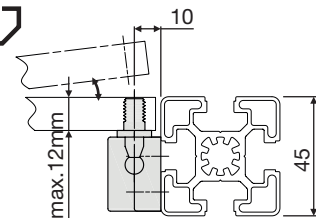
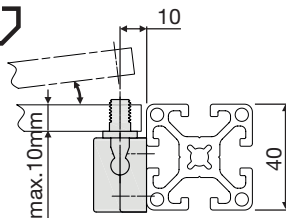
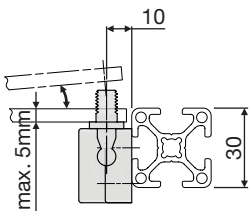

Winkel

Bracket · Equerre

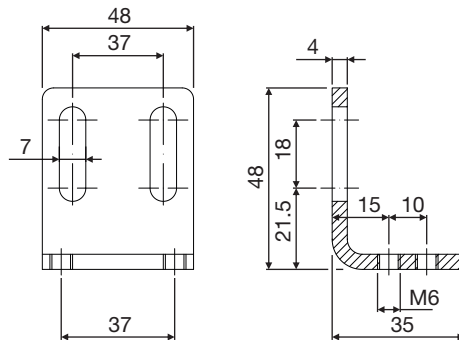
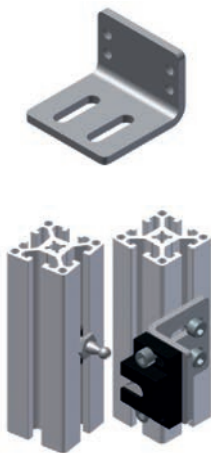

05.02317.00

St, verzinkt
Der Befestigungswinkel ist in
den Profilreihen 40, 45 und
50 universell einsetzbar

Steel, galvanized
The fastening bracket can be
used universally in the profile
series 40, 45 and 50

Acier, zingué
L'équerre de fixation s'utilise
de manière universelle pour
les séries de profilés 40, 45 et
50

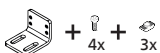
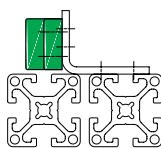

05.02317.11

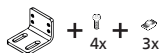
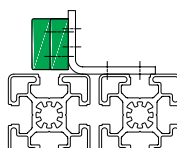

05.02317.12

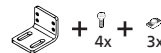
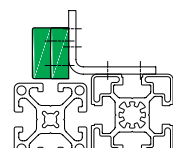

05.02317.13

Technische Änderungen vorbehalten

DOPPELKUGELSCHNÄPPER PA

TWIN BALL CLIP PA

FERMETURE A BILLES PA

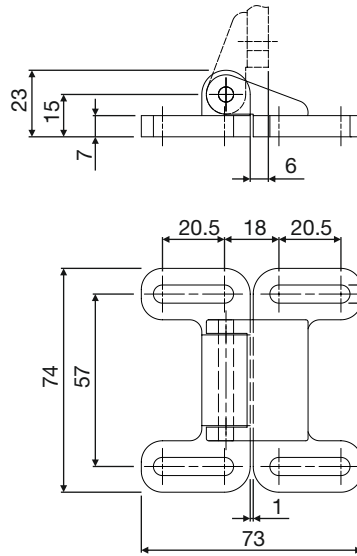
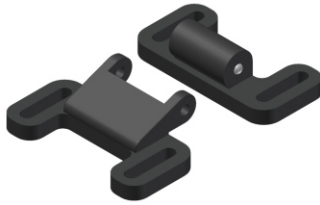
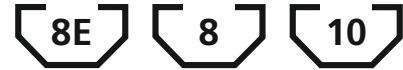

05.02318.00

PA, glasfaserverstärkt
Universeller Schnellverschluss
für Klappen, Schiebe- und
Schwenktüren mit und ohne
Rahmen

PA, fibreglass reinforced
Universal quick closure for
flap, sliding and swing doors
with and without frame

PA, renforcé fibres de verre
Blocage et butée pour porte
coulissante ou battante avec
ou sans encadrement

Befestigung

Fastening · Fixation

30 / 40

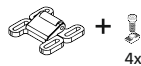
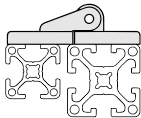

05.02318.11

40 / 45

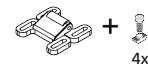
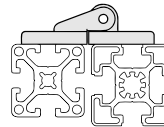

05.02318.13

40 / 40

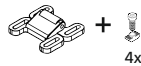
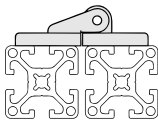

05.02318.12

45 / 45

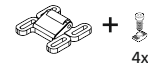
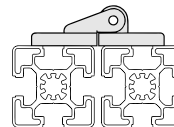

05.02318.14

Anwendung

Application · Application

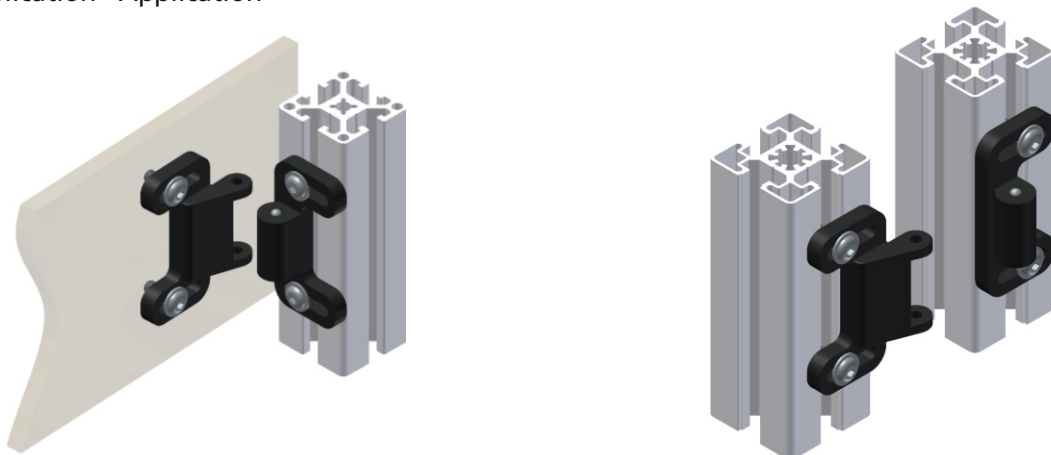

Technische Änderungen vorbehalten

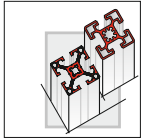

DOPPELKUGELSCHNÄPPER MS

TWIN BALL CLIP MS

FERMETURE A BILLES MS

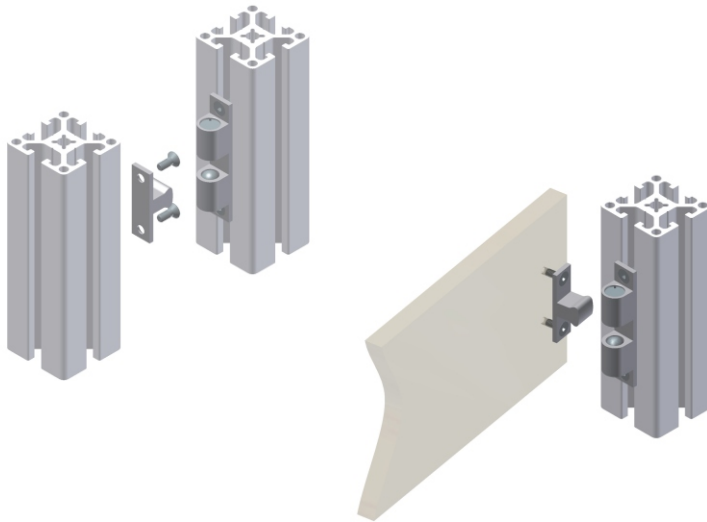

05.02319.00

Messing, verchromt,
Einrastdruck verstellbar, zwei
Anwendungsmöglichkeiten
0° / 90°

Brass, chrome-plated
Adjustable clipping pressure,
two application possibilities
0° / 90°

Laiton, chromé
Pression d'encliquetement
réglable, deux possibilités
d'application
0° / 90°

0°

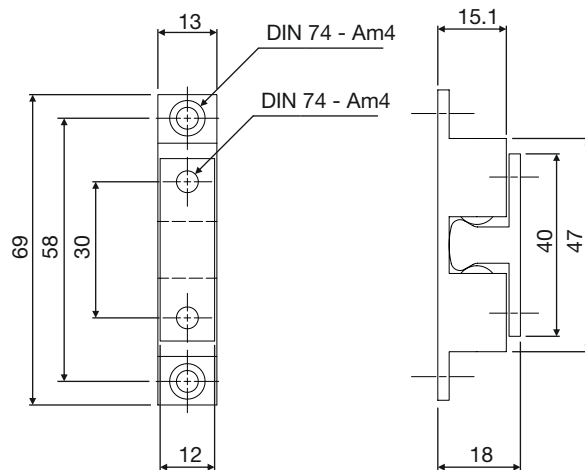
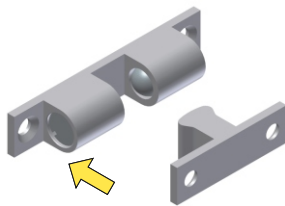

90°

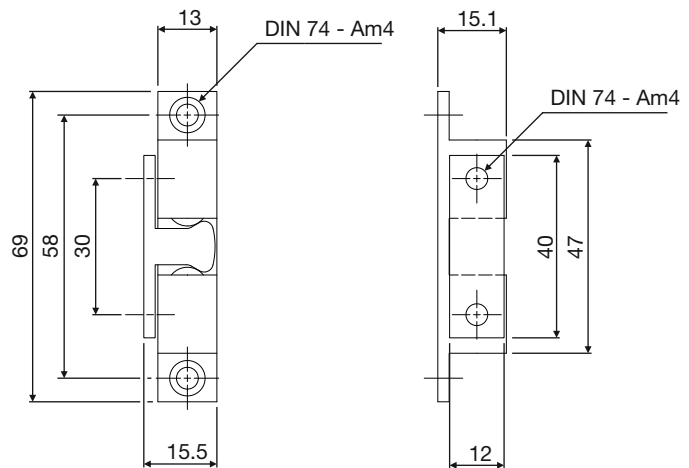
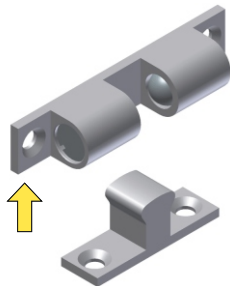

Technische Änderungen vorbehalten

MAGNETVERSCHLUSS PA

MAGNETIC CLOSURE PA

VERROUILLAGE MAGNETIQUE PA

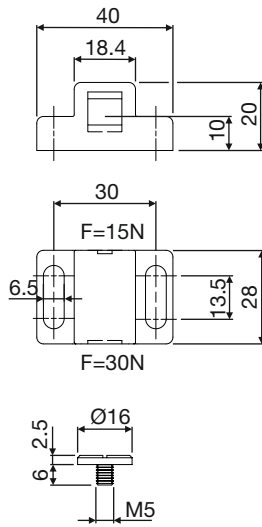
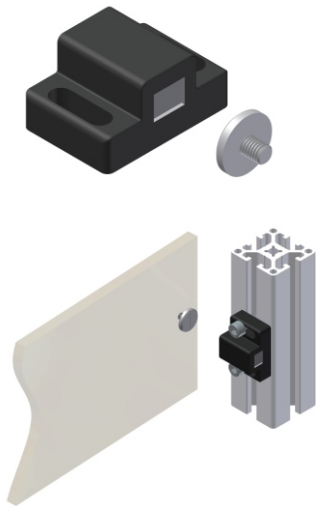

05.01650.00

PA, glasfaserverstärkt
Geeignet zur Zuhaltung von
Schiebe- und Schwenktüren;
unterschiedliche Haltekraft
des Magnetverschlusses

PA, fibreglass reinforced
Suitable for closure of sliding
and swing doors; variable
retaining force of magnetic
closure

PA, renforcé fibres de verre
Adapté pour maintenir
fermées les portes coulissantes
et battantes; deux forces de
résistance

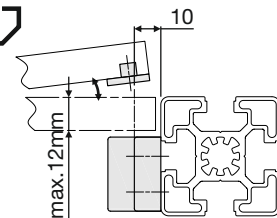
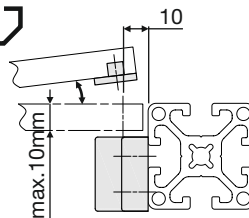
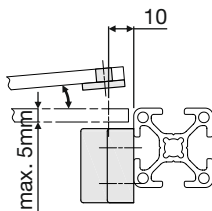

Winkel

Bracket · Equerre

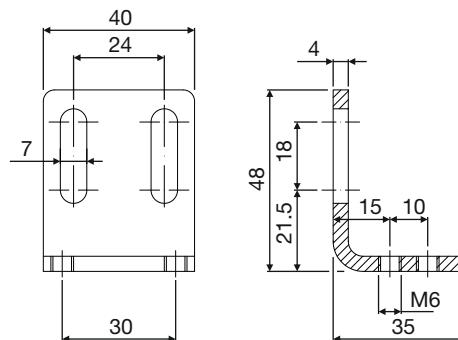
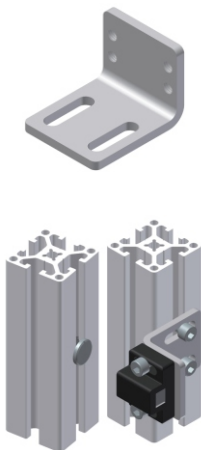

05.01651.00

St, verzinkt
Der Befestigungswinkel ist in
den Profilreihen 40,45 und
50 universell einsetzbar

Steel, galvanized
The fastening bracket can be
used universally in the profile
series 40, 45 and 50

Acier, zingué
L'équerre de fixation convient
de manière universelle pour
les séries de profilés 40, 45 et
50

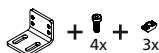
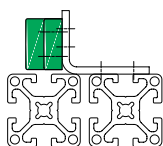

05.01651.11

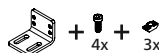
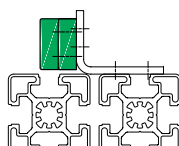

05.01651.12

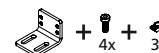
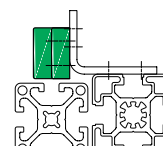

05.01651.13

Technische Änderungen vorbehalten

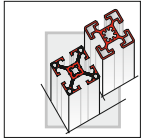

SICHERHEITSSCHALTER SAFETY SWITCH CONTACTEUR DE SECURITE

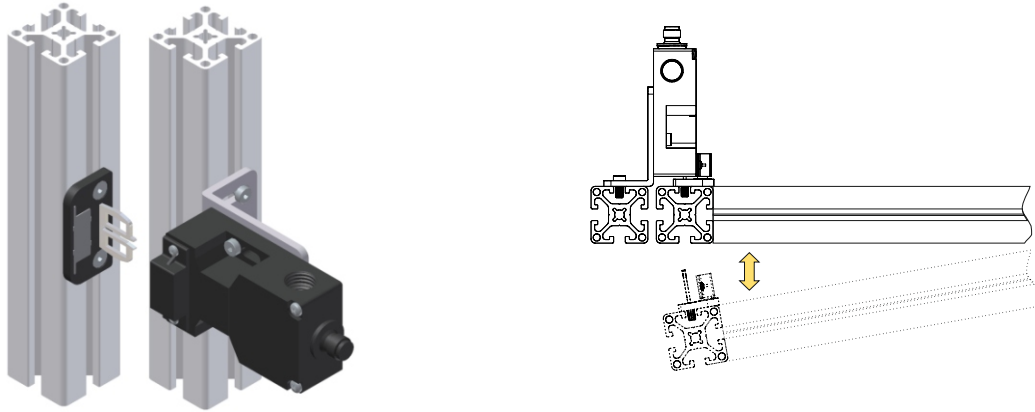

Innovative Vorteile

- Zum sicheren Verschließen von Schutzgittern, Hauben und Türen um die erforderliche Betriebssicherheit zu gewährleisten
- Durch Langloch universelle Anordnung möglich
- Einsatz in der Profilvereihe 40,45 und 50 möglich

Innovative advantages

- For secure fastening of safety screens, hoods and doors in order to ensure the required operating safety
- Oblong hole for universal application
- Can be used in profile series 40, 45 and 50

Atouts novateurs

- Pour la fermeture sécurisée de portes et de carters de protection
- Par un long trou l'ordre universel possible
- Application possible pour les séries de profilés 40, 45 et 50

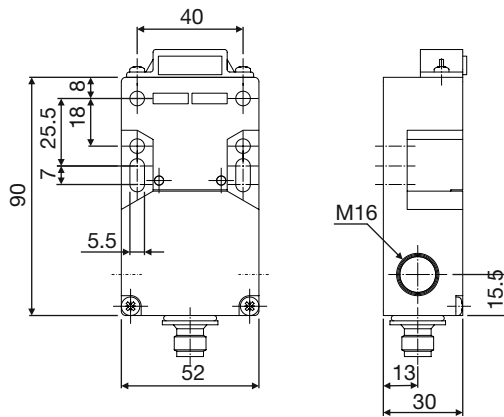
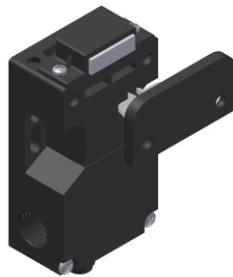

05.02050.00

Winkel

Brackets · Équerres

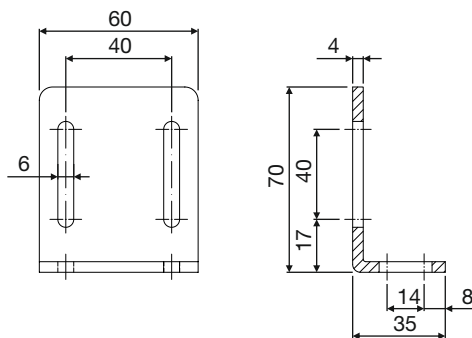
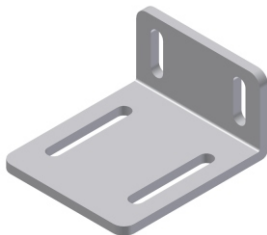

05.02054.00



05.02054.11

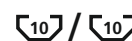

05.02054.12



05.02054.13

Technische Änderungen vorbehalten

POTENTIALAUSGLEICH / ANSCHLAGPUFFER

POTENTIAL EQUALIZER EQUALISEUR

POTENTIEL

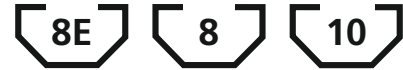

Potentialausgleich

05.01542.00



- Bestehend aus:
- | | |
|----------------|---------|
| Hammerschraube | St, vz. |
| ISO-Scheibe | St, vz. |
| Zahnscheibe | St, vz. |
| Flanschmutter | St, vz. |
| Ringkabelschuh | St |
- Consisting of:
- | | |
|-------------------|-----------|
| T-Bolt | St, galv. |
| ISO washer | St, galv. |
| Tooth washer | St, galv. |
| Flange nut | St, galv. |
| Crimp type socket | St |
- Comprenant:
- | | |
|-----------------|-----------|
| Vis 1/4 de tour | Ac, zing. |
| Rondelle | Ac, zing. |
| Disque denté | Ac, zing. |
| Ecrou | Ac, zing. |
| Cosse de câble | Ac |

Typ A

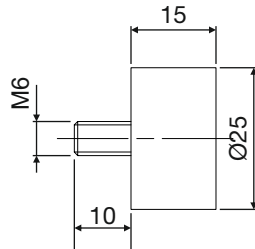

05.01510.00

- Gummi, schwarz
50-55 Shore
- Rubber, black
50-55 Shore
- Caoutchouc, noir
50-55 Shore

Typ B

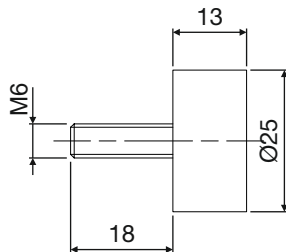

05.01511.00

- Gummi, schwarz
50-55 Shore
- Rubber, black
50-55 Shore
- Caoutchouc, noir
50-55 Shore

Typ C

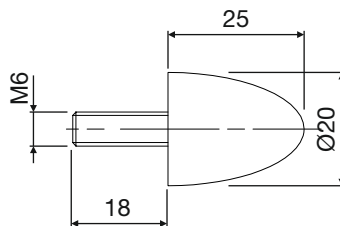

05.01512.00

- Gummi, schwarz
50-55 Shore
- Rubber, black
50-55 Shore
- Caoutchouc, noir
50-55 Shore

Anwendung

Application · Application

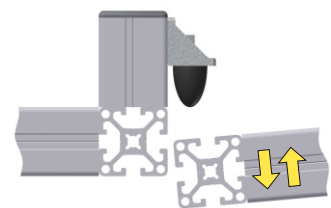
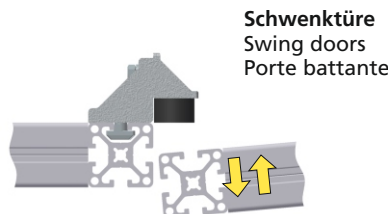
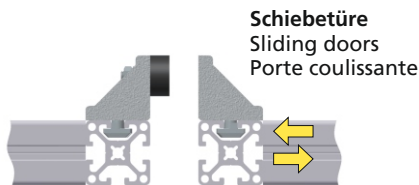

Technische Änderungen vorbehalten



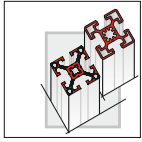

GRIFFE, SCHLÖSSER HANDLES, LOCKS POIGNEES, SERRURES



Klinkengriff

Latch handle · Poignée bec de cane

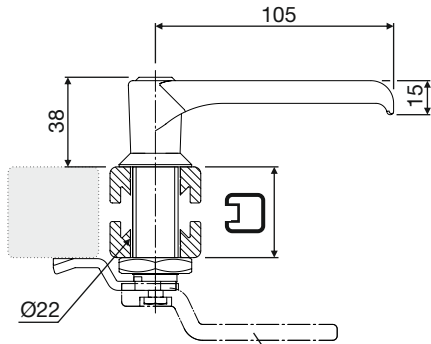

siehe Notgriff
see emergency handle
voir poignée d'urgence



- 05.02060.00
- 05.02062.00
- 05.02065.00



- 05.02061.00
- 05.02063.00
- 05.02066.00

Notgriff

Emergency handle · Poignée d'urgence

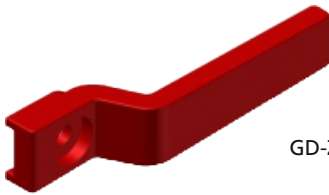

GD-Zn, RAL 3032

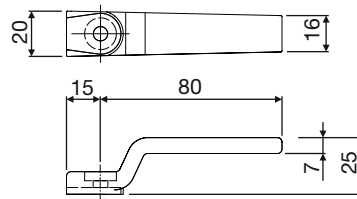

05.02064.00

Fallenverschluss

Lock · Bloc serrure

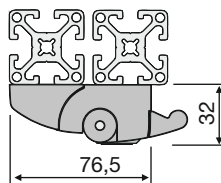
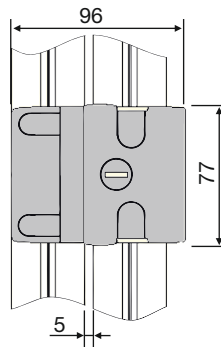

05.02133.00

Aluminiumdruckguss,
schwarz, pulverbeschichtet

Die-cast aluminium,
black powder cated

Aluminium,
peinture noire

Fallenverschluss mit Schloss,
gleichschließend

Lock for uniform locking

Bloc serrure
pour portes battantes

Technische Änderungen vorbehalten

KNIEHEBELVERSCHLUSS

TOGGLE CATCH

FERMETURE A GENOUILLERE



Innovative Vorteile

- Für Türen und Fenster
- Mit Anpressdruck schließbar

Innovative advantages

- For doors and windows
- Lockable with pressure

Atouts novateurs

- Pour portes et fenetres
- Fermable avec pression

ohne Schloss

without lock · sans serrure

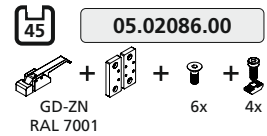
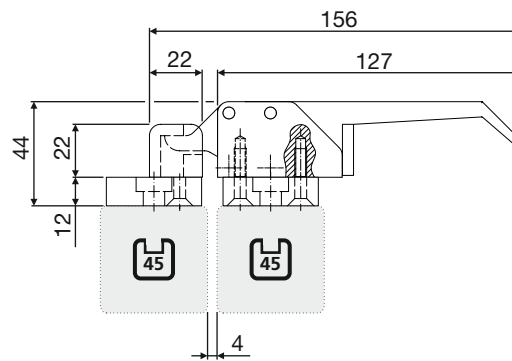
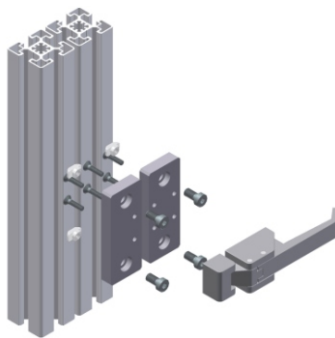

mit Schloss

with lock · avec serrure

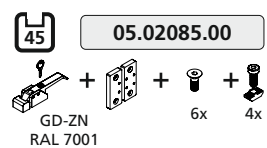
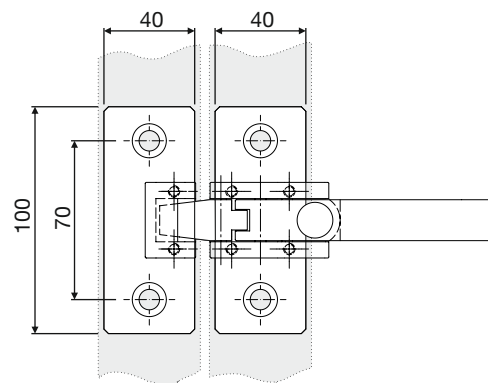
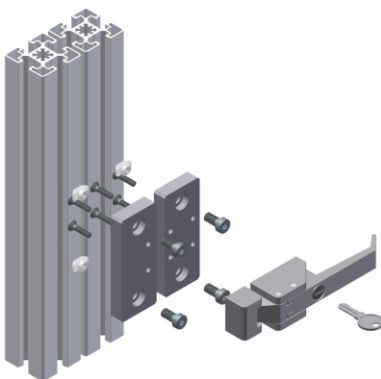

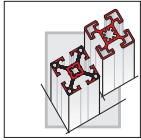

TÜRSCHLOSS DOOR LOCK SERRURE



Einsteckschloss

Insert lock · Serrure enfichable de porte battante

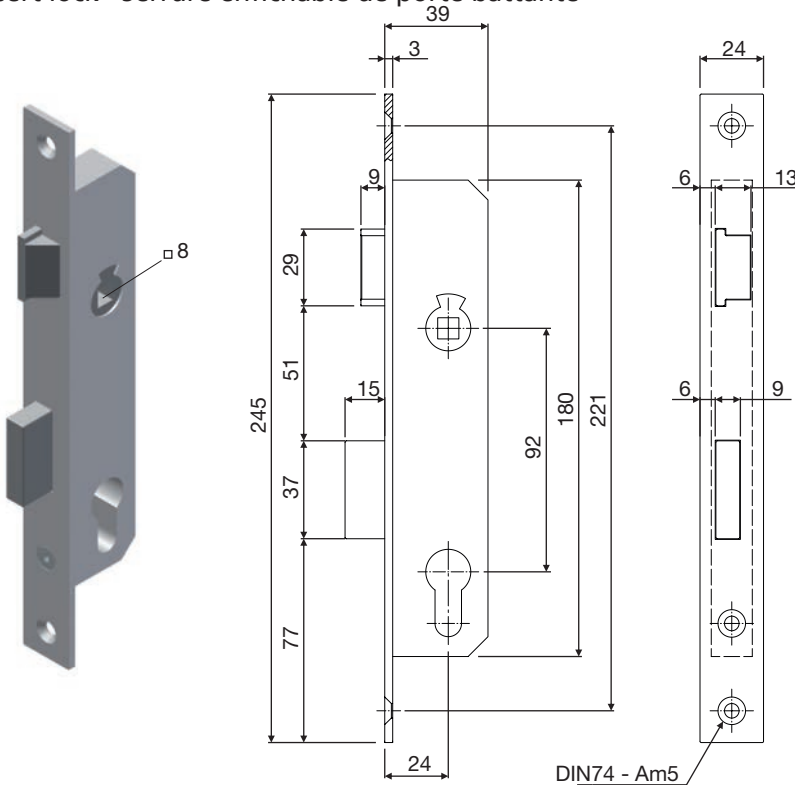

Ausführung rechts
Design right
Version droite

05.02320.00

Ausführung links
Design left
Version gauche

05.02320.50

Einsteckschloss, Stahl vz.
Für Schließzylinder von
Schwenktüren mit
Profilrahmen aus Profil 40x40
und 40x80

Insert lock, steel galvanized
For locking cylinder for swing
doors with profile frame
made of 40x40 or 40x80
profile

Serrure enfichable, acier
Zingué avec cylindre pour
portes battantes avec cadre
en profile 40x40 ou 40x80

Profilbearbeitung

Profile finishing · Usinage de profiles

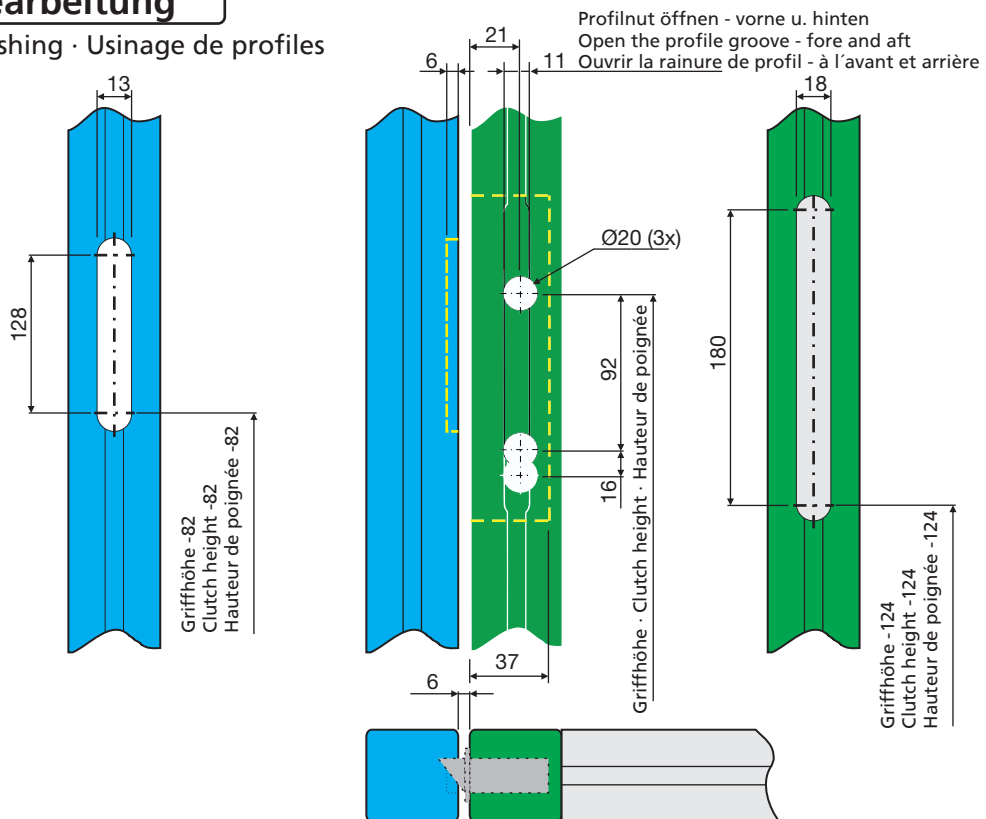

Technische Änderungen vorbehalten

TÜRSCHLOSS

DOOR LOCK

SERRURE



Schiebetürschloss

Sliding door lock · Serrure portes coulissantes

links **05.02394.00**

rechts **05.02394.10**

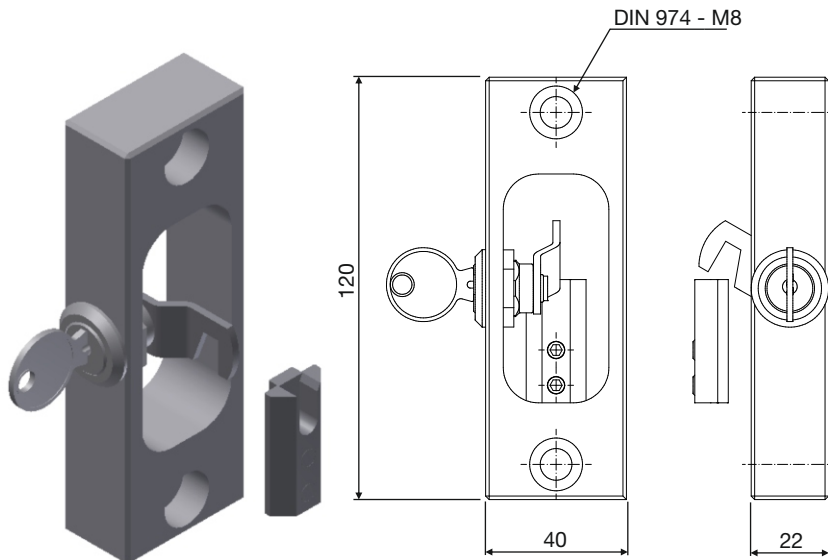

Ausführung rechts
Design right
Version droite

Ausführung links
Design left
Version gauche

Schiebetürschloss,
Alu, eloxiert E6ev1, mit
Drehriegel; für Schiebetüren
mit Profilrahmen aus Profil
40x40

Insert door lock,
Aluminium, anodized, with
locking cylinder; for sliding
doors with profile frame
made of 40x40 profile

Serrure enfichable de porte
coulissante,
Alu, anodisé, avec cylindre;
pour portes coulissantes avec
cadre en profil 40x40

Profilbearbeitung

Profile finishing · Usinage de profiles

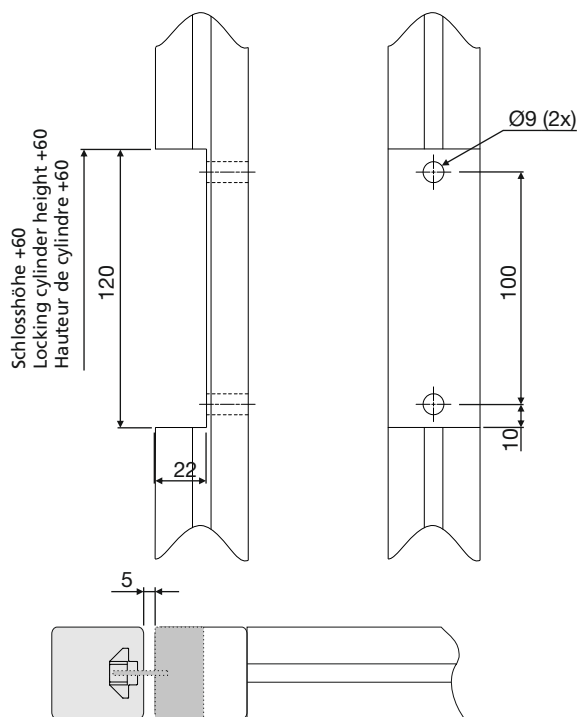

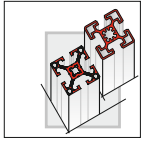

TÜRSCHLOSS ZUBEHÖR

DOOR LOCK ACCESSORIES

SERRURE ACCESSOIRE



Innovative Vorteile

- Individuelle Auswahl und Kombinationen
- Einheitliches System
- Komplette Serie aus Aluminium, eloxiert
- Elemente sind für Schiebetüren geeignet

Innovative advantages

- Individual choice and combinations
- Standard system
- Complete series made of aluminium, anodised
- Elements suitable for swing and sliding doors

Atouts novateurs

- Choix individuel et combinaison
- Système unitaire
- Série complète en aluminium anodisé
- Les éléments sont adaptés pour les portes battantes

Schlüsselschild

Escutcheon · Ecusson

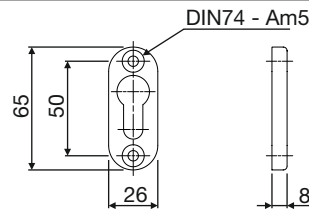

05.02322.00

Türdrücker

Door handle · Poignée de porte

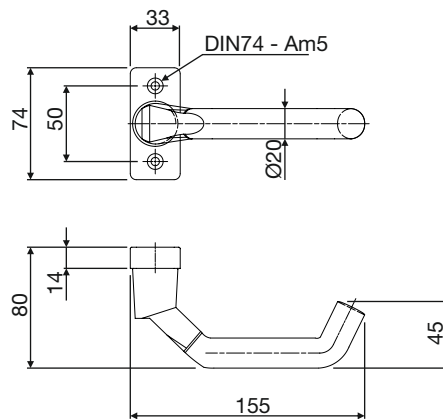
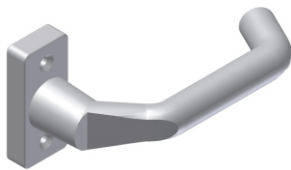

05.02323.00

Türknoopf Ø50, drehbar

Door knob Ø50, turnable · Bouton de porte Ø50, tournant

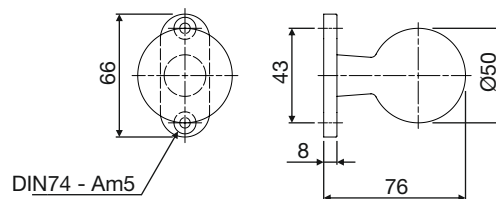

05.02324.00

Türknoopf Ø55, starr

Door knob Ø55, rigid · Bouton de porte Ø55, fixe

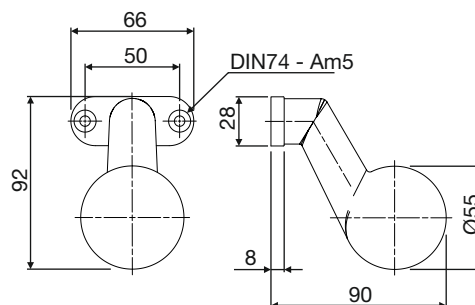

05.02325.00

TÜRSCHLOSS KOMPLETTE GARNITUR

DOOR LOCK FITTINGS COMPLETE

SERRURE KIT COMPLET



Typ 1

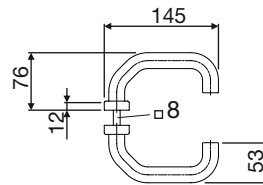
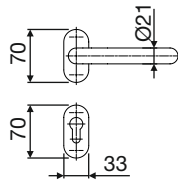

- ohne Schließzylinder
- without lock cylinder
- sans cylindre de serrure

05.02326.00

Typ 2

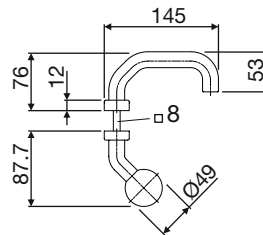
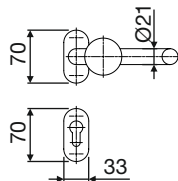

- ohne Schließzylinder
- without lock cylinder
- sans cylindre de serrure

05.02327.00

Typ 3

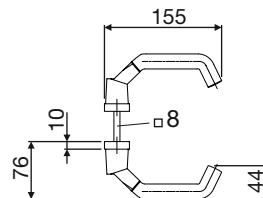
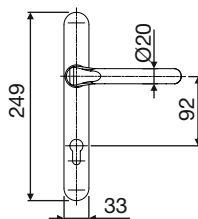

- ohne Schließzylinder
- without lock cylinder
- sans cylindre de serrure

05.02328.00

Typ 4

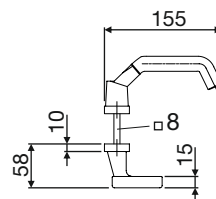
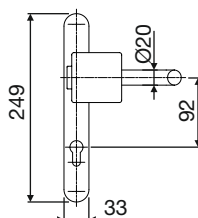

- ohne Schließzylinder
- without lock cylinder
- sans cylindre de serrure

05.02329.00

Schließzylinder

Locking cylinder · Cylindre enfichable

Schließzylinder für Schwenktüren mit Profilrahmen aus Profil 40x40 und 40x80

Locking cylinder for swing doors with profile frame made of 40x40 or 40x80 profile

Serrure enfichable avec cylindre pour portes battantes avec cadre en profile 40x40 ou 40x80

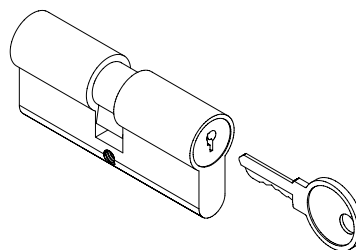

- gleichschließend
- simultaneous locking
- s'entrouvrant

05.02330.00

- verschieden schließend
- differently keyed
- clé différente

05.02331.00

Technische Änderungen vorbehalten

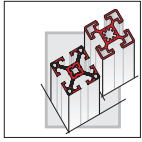

SCHIEBETÜRPROFIL

SLIDING DOOR PROFILE

PROFILE DE PORTE COULISSANTE



Merkmale

Schiebetüren und -fenster sichern Maschinen und Einrichtungen und schützen vor Staub und Schmutz.

Characteristics

Sliding doors and windows safeguard machines and equipment and protect against dust and dirt.

Caracteristique

Les portes et fenêtres coulissantes protègent les machines et installations des poussières et saletés.

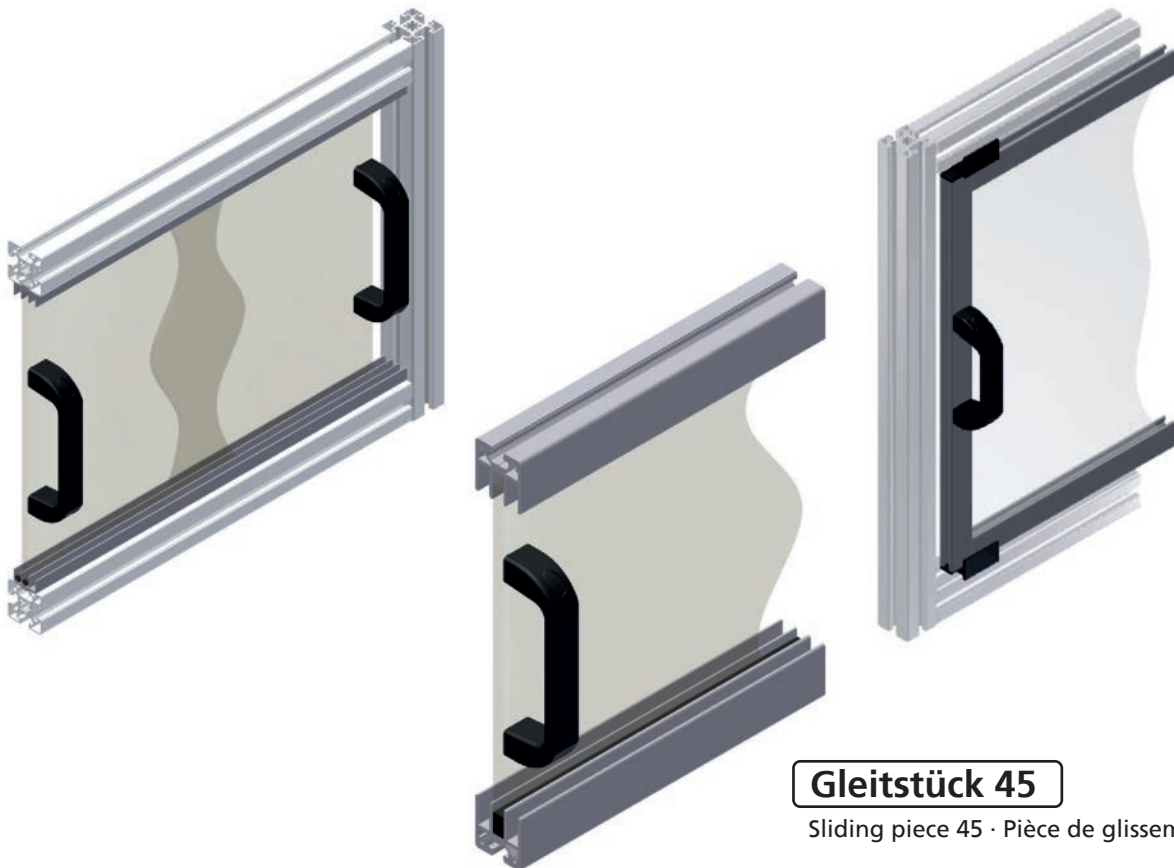

Gleitstück 45

Sliding piece 45 · Pièce de glissement 45

30x15

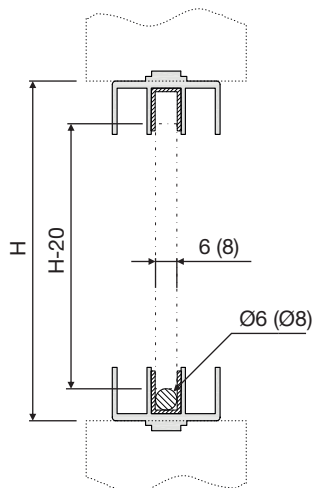

45x45

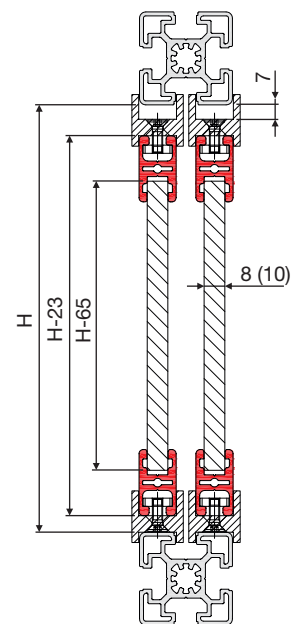
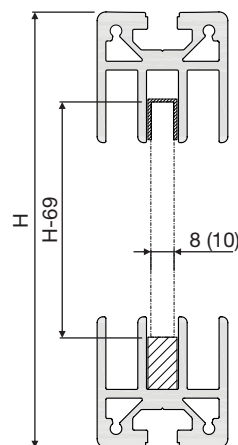

Technische Änderungen vorbehalten

SCHIEBETÜRPROFIL

SLIDING DOOR PROFILE

PROFILE DE PORTE COULISSANTE



30x15

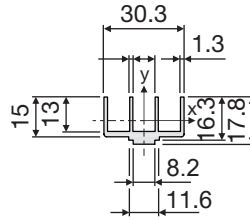
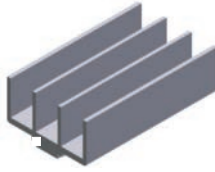

05.01048.00

M = 0.42 kg/m

PE (m)
6

Aluminium, eloxiert
Aluminium, anodized
Aluminium, anodisé

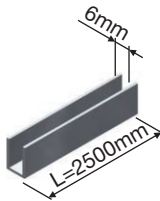

05.01049.00

Reduzierprofil
Reduction profile
Profilé réduction

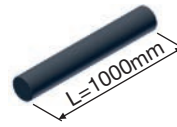

05.02336.00

Ø6 mm, PE

05.02337.00

Ø8 mm, PE

45x45

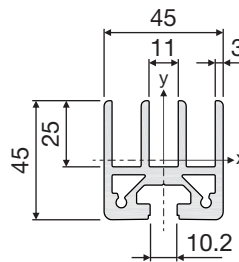

05.01599.00

M = 2,12 kg/m

PE (m)
6 / 48 / 96

Aluminium, eloxiert
Aluminium, anodized
Aluminium, anodisé

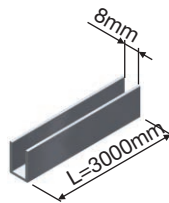

05.02338.00

Führungsprofil oben
Guide profile, top
Profilé de guidage, en haut

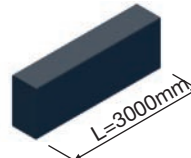

05.02339.00

10x18 mm, PE

Gleitstück 45

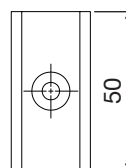
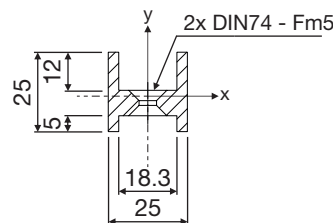

05.02053.01



05.02053.05

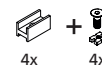

PE-HD, schwarz
PE-HD, black
PE-HD, noir

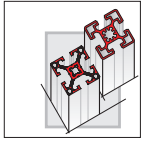

PROFILRAHMEN FÜR SCHIEBEFENSTER

PROFILE FRAME FOR SLIDING WINDOWS

CHASSIS EN PROFILE POUR FENETRE COULISSANTE



Merkmale

Klemmprofil 18x32 zum Bau von leichten Rahmen, für Schiebe- und Hubfenster.

Flächenelemente mit 10 mm Dicke können direkt eingebaut werden. Flächenelemente von 2-8 mm werden mit Einfassprofil eingebaut.

Characteristics

Clamping profile 18x32 for construction of lightweight frames, for sash and lift windows.

Area elements 10 mm thick can be installed direct. Area elements 2-8 mm thick are installed with clamping profile.

Caracteristique

Profilé de serrage 18x32 pour la réalisation de châssis légers pour fenêtres coulissantes et fenêtres à guillotine.

Les panneaux de remplissage d'une épaisseur de 10 mm peuvent être encastrés directement. Ceux de 2-8 mm se montent avec un joint baguette.

Befestigung

Fastening · Fixation

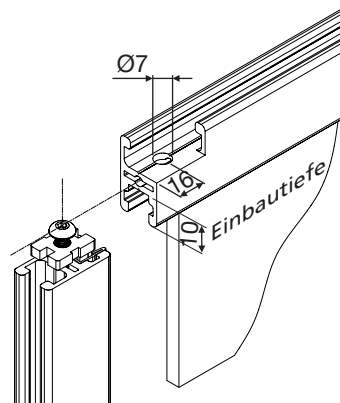

→ ■ 3.23

05.01404.00



→ ■ 3.32

05.01886.00

Klemmprofil 18x32

Clamping profile 18x32 · Profilé 18x32

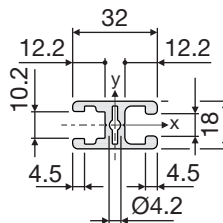
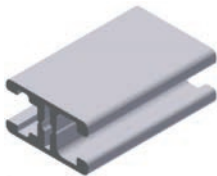

05.01711.00

M = 0.67 kg/m
 $I_x = 11.00 \text{ cm}^4$
 $W_x = 12.22 \text{ cm}^3$
 $I_y = 18.52 \text{ cm}^4$
 $W_y = 11.58 \text{ cm}^3$

PE (m)

6 / 18 / 36 / 54

Abdeckkappe 18x32

Cover cap 18x32 · Cache 18x32

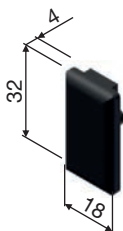

05.01749.00

PA schwarz
 black
 noir

Einfassprofil

Clamping profile · Joint baguette



→ ■ 7.03

05.01830.00

Technische Änderungen vorbehalten

SCHIEBEFENSTER MIT PROFILRAHMEN

SLIDING WINDOW WITH PROFILE FRAME

FENETRE COULISSANTE AVEC CHASSIS EN PROFILE



Merkmale	Characteristics	Caracteristique
Schiebefenster mit Profilrahmen aus Klemmprofil 18x32 und Schiebegerleiter-Sätzen.	Sliding window with profile frame made of clampin profile 18x32 and slider sets.	Fenêtre coulissante avec châssis en profilé 18x32 et patins de glissement.
Die Befestigung erfolgt durch Einrasten eines Federbolzens in die Montagebohrung Ø7 des Klemmprofils 18x32. Das Gleitstück kann durch eine zusätzliche Bohrung Ø7 an beliebiger Stelle fixiert werden.	Fastening by latching spring bolt into the assembly hole Ø7 of the clamping profile 18x32. The sliding element can be fastened at required point using an additional hole Ø7.	La fixation s'effectue en encliquetant un boulon à ressort. Dans le perçage de montage Ø7 du profilé 18x32. L'élément coulissant peut être fixé quel que soit l'endroit, en effectuant un perçage supplémentaire.
Es können wahlweise 1 oder 2 Schiebefenster in einer Profilnut 8 geführt werden. Die Gleitstücke bilden einen Mitnehmer des zweiten Fensters.	A choice of 1 or 2 sash windows can be run in a profile groove 8. The sliding elements form a catch for the second window.	On peut au choix guider 1 ou 2 fenêtres coulissantes dans une rainure de profilé 8. Les éléments coulissants forment un taquet d'entraînement de la deuxième fenêtre.

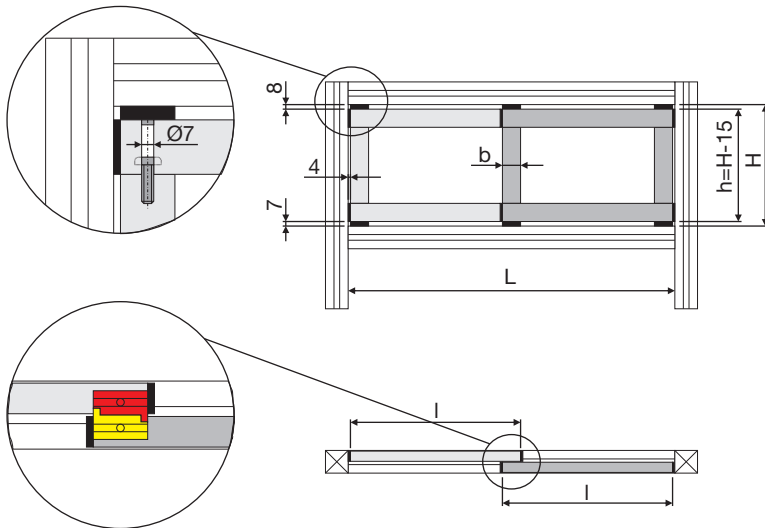

Das zulässige Gewicht eines Fensters beträgt max. 10 kg.

The permitted weight of a window is max. 10 kg.

Le poids admissible d'une fenêtre est de max. 10 kg.

$$l = \frac{L-8 + (n-1)b}{n}$$

N = Anzahl
Number of
Nombre

8

Schiebegleiter

Slider · Patins de glissement

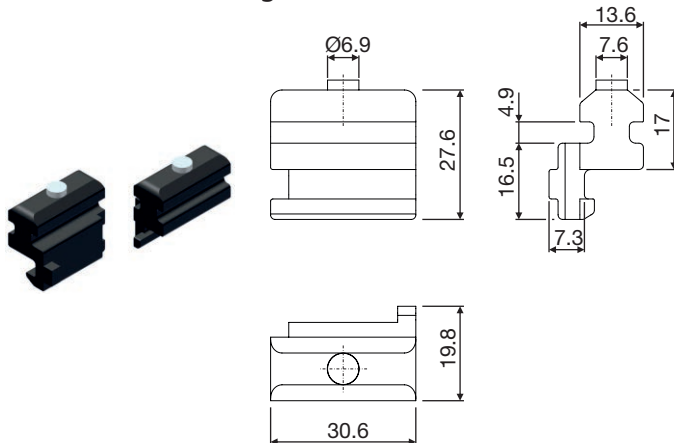

05.02340.00

Satz für Schiebetür-Führung besteht aus
2x rechts und 2x links
Tracking set for sliding windows consists of
2x right and 2x left
Le guidage pour fenetre coulissante se compose de
2x droite et 2x gauche

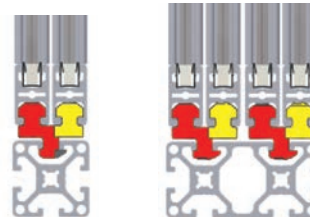

Technische Änderungen vorbehalten

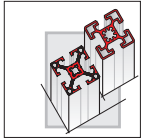

FALTTÜREN

FOLDING DOORS

PORTES ACCORDEON



Merkmale

Das Falttürelement ist für gleichzeitige Dreh- und Gleitbewegungen ausgelegt und hat eine sehr hohe Lebensdauer.

Max. Biegemoment M: 20 Nm
Max. Gewichtsbelastung F: 120 N

Characteristics

The folding door element is designed for simultaneous rotary and sliding door movements and has a very long service life.

Max. moment of flexion M: 20 Nm
Max. load F: 120 N

Caracteristique

Le module accordéon est conçu pour des mouvements glissants et rotatifs simultanés. Très bonne fiabilité.

Moment de flexion M : 20 Nm
Charge maximale F : 120 N

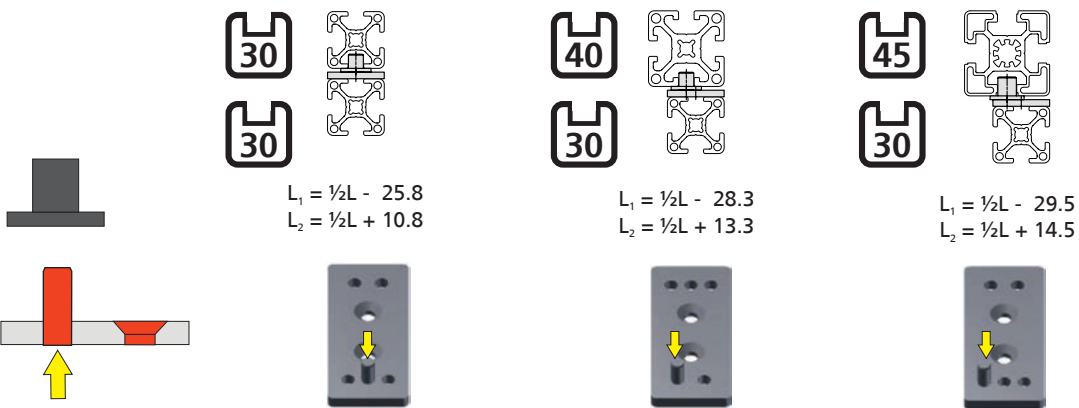
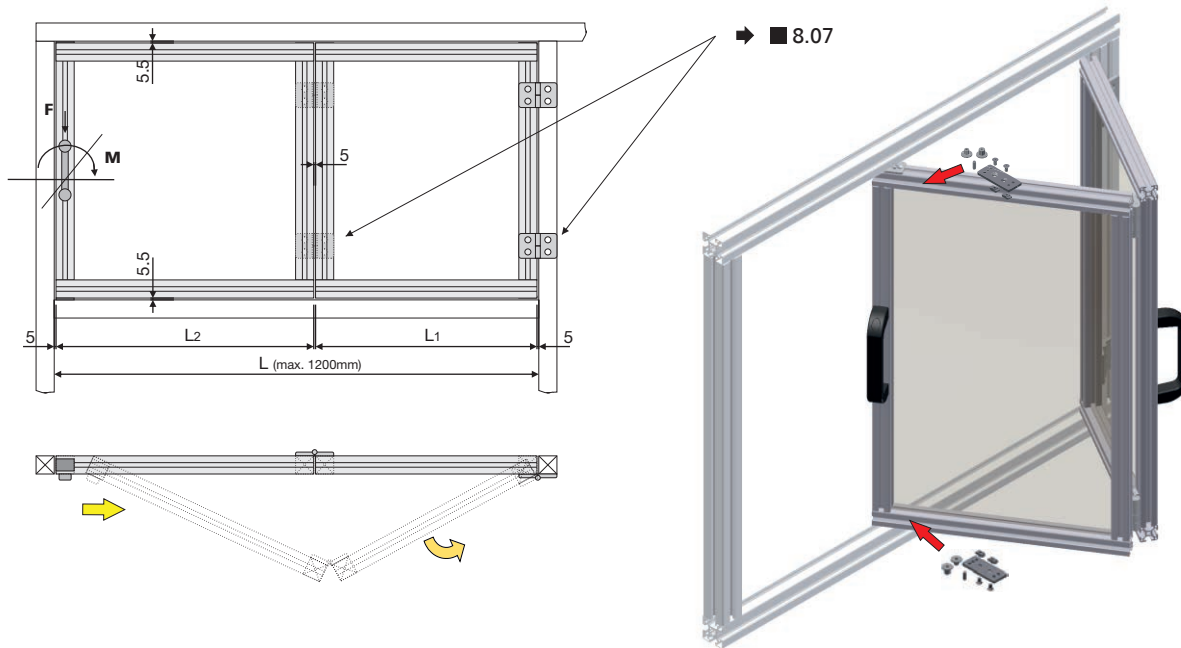

Falttürelement

Folding door elements · Interface pour support de pions



05.01600.00



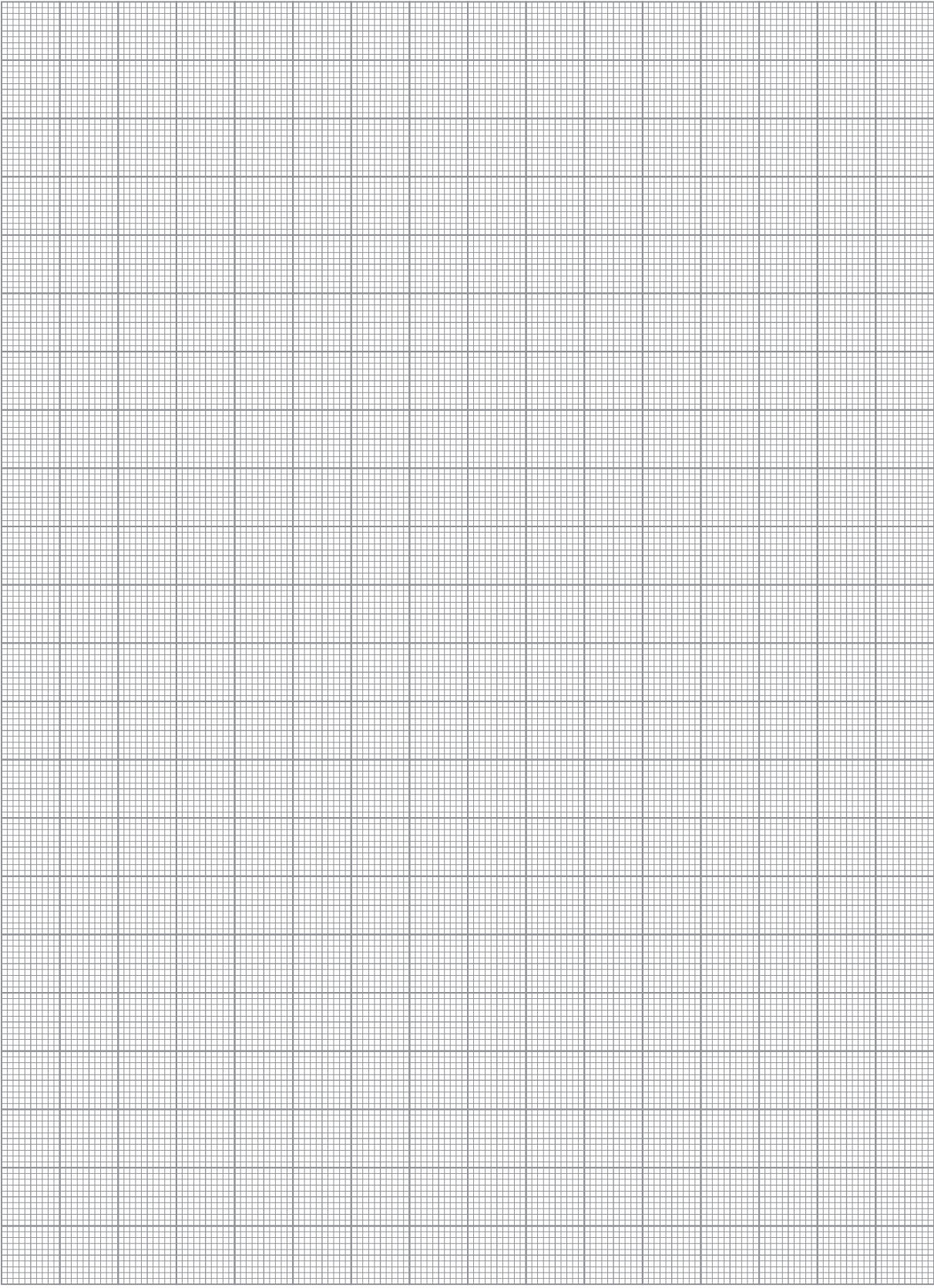

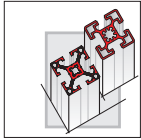

SCHWENKTÜREN SWING DOORS PORTES BATTANTES



Merkmale

FM Schwenktüren sind mit stabilen Alu-Scharnieren ausgerüstet. Das reichhaltige Zubehör ermöglicht eine vielfältige Ausführung.

Characteristics

FM swivel doors are fitted with sturdy aluminium hinges. The extensive range of accessories allows a wide variety of designs.

Caracteristique

Les portes battantes FM sont équipées de charnières alu robustes. La diversité des accessoires permet une grande variété d'applications.

Ausführung links
Design left
Version gauche

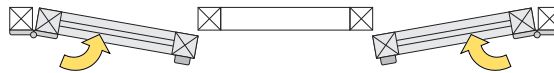

Ausführung rechts
Design right
Version droite

Anwendung

Application · Application

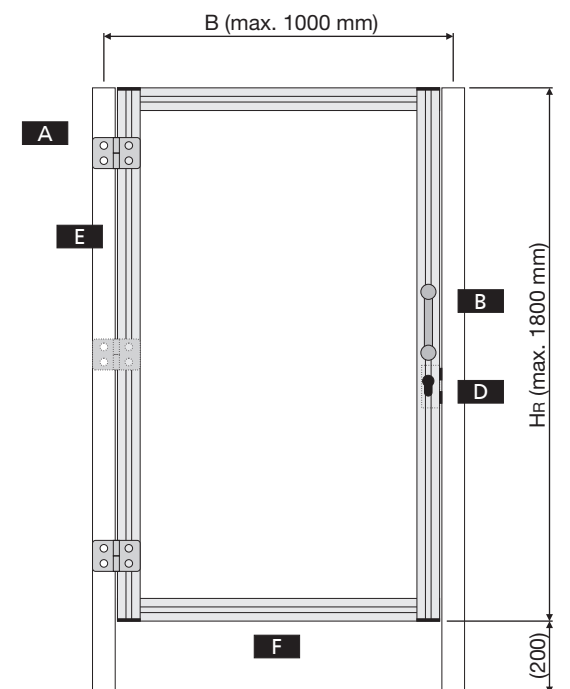

- A** Scharniere Hinges Charnières → ■ 8.08
- B** Griffe Handles Poignées → ■ 8.12
- C** Haltesysteme Retaining systems Systèmes de maintien → ■ 8.20
- D** Schließsysteme Locking systems Systèmes de fermeture → ■ 8.22
- E** Geeignete Stützen Suitable supports Montants adaptés → ■ 11.05
- F** Empfohlene Profilreihen Recommended profile series Séries de profilés conseillées



→ ■ 2.23



→ ■ 2.55

B	x	H	
750		1800	05.05071.20
850		1800	05.05072.20
1000		1800	05.05073.20

SCHIEBETÜREN

SLIDING DOORS

PORTES COULISSANTES



Merkmale

FM Schiebetüren mit einem Alu C-Schienenprofil und leichtgängigen Rollenwagen. Die untere Zusatzführung über eine Führungsrolle sichert die Tür gegen Ausschwenken.

Characteristics

FM sliding doors with an aluminium-C-profile and easy running roller carriage. Additional lower guidance by guide roller prevents the door from swinging out.

Caracteristique

Portes coulissantes FM équipées de profilé alu C et d'un chariot de roulement d'excellente mobilité. Le guidage inférieur complémentaire par galet assure le guidage intérieur.

Anwendung

Application · Application

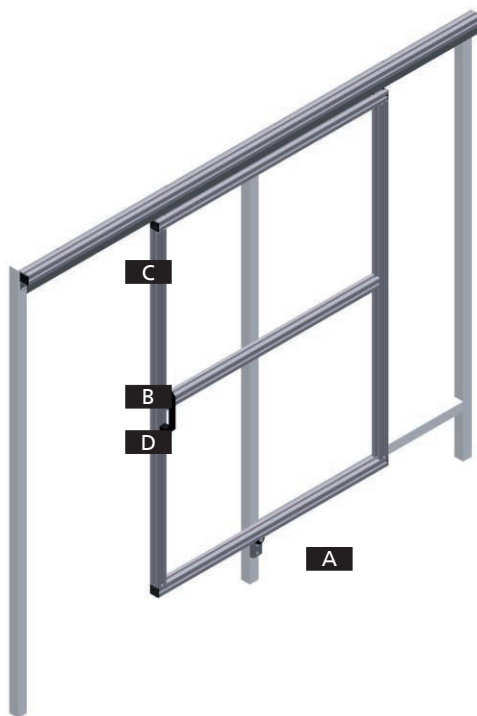

- A** Laufrollen
Rollers
Galets → ■ 6.08
- B** Griffe
Handles
Poignées → ■ 8.12
- C** Haltesysteme
Retaining systems
Systèmes de maintien → ■ 8.20
- D** Schließsysteme
Locking systems
Systèmes de fermeture → ■ 8.22

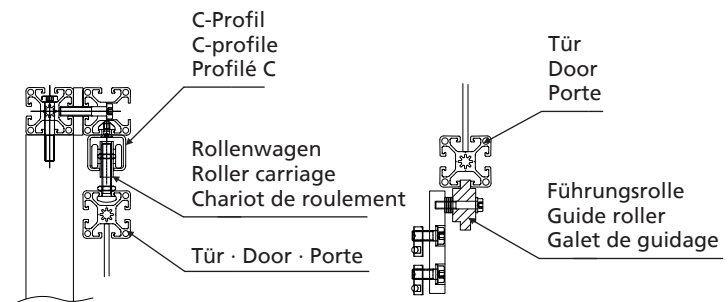

Typ 1

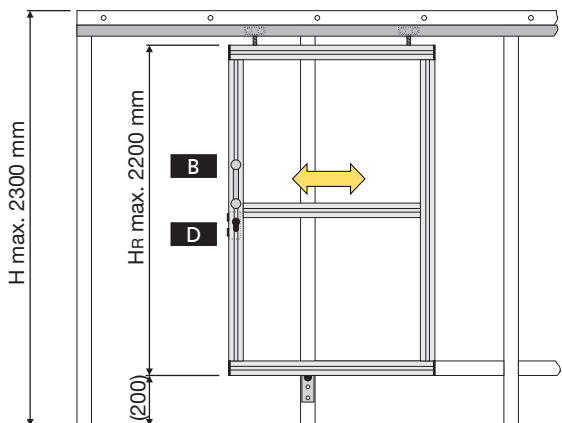

Typ 2

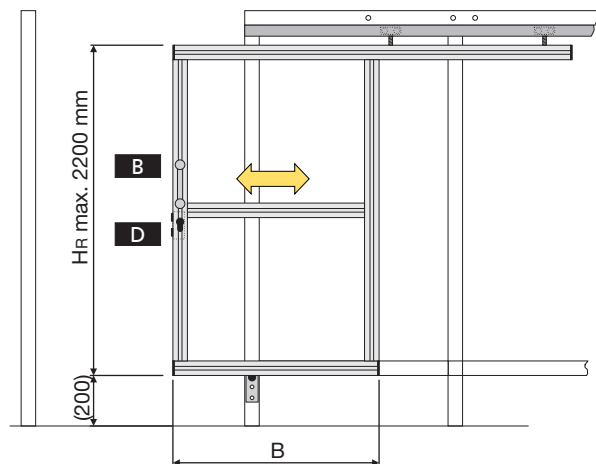

Technische Änderungen vorbehalten

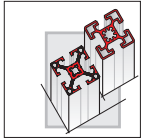

SCHARNIERPROFIL OHNE PROFILRAHMEN

HINGE PROFILE WITHOUT PROFILE FRAME

PROFILE CHARNIERE SANS CADRE DE PROFILE



Merkmale

- Scharnier für frei tragende Flächenelemente ohne Spalt zum Anschluss-Profil.

Characteristics

- Hinge for free-weight-bearing surface elements without gap to the connection profile.

Caracteristique

- Charnière pour les éléments de surface librement portant sans fente au profil de correspondance.

45x22

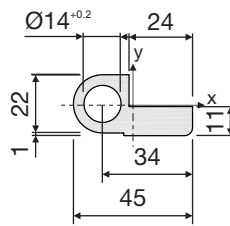
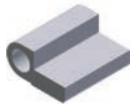

05.01948.00

M = 1.40 kg/m
 $I_x = 2.50 \text{ cm}^4$
 $W_x = 2.27 \text{ cm}^3$
 $I_y = 8.10 \text{ cm}^4$
 $W_y = 3.60 \text{ cm}^3$

PE (m)
 6 / 48 / 96 / 144

45x22

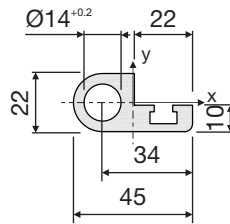
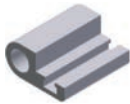

05.01949.00

M = 1.23 kg/m
 $I_x = 2.24 \text{ cm}^4$
 $W_x = 2.03 \text{ cm}^3$
 $I_y = 6.84 \text{ cm}^4$
 $W_y = 3.04 \text{ cm}^3$

PE (m)
 6 / 36 / 72 / 108

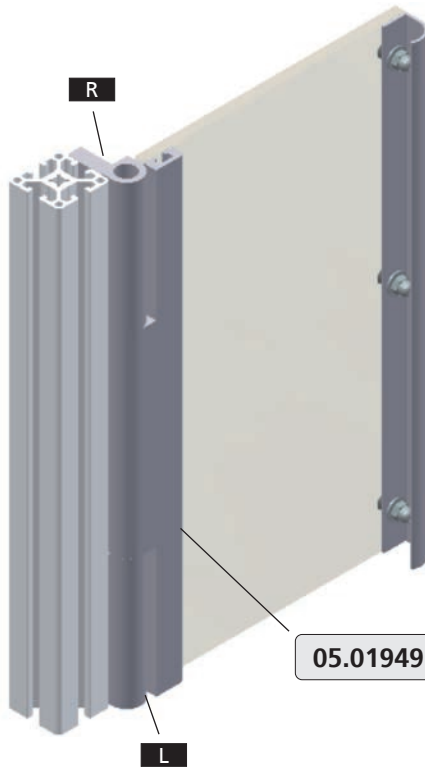

Endstück komplett



05.01304.40

L

End piece complete

05.01305.40

R

Ensemble complet



05.01304.45

L

05.01305.45

R

05.01949.10 L = mm



120°



110°

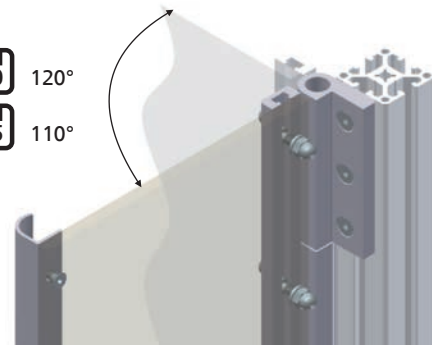

Technische Änderungen vorbehalten

INSTALLATIONSELEMENTE INSTALLATION ELEMENTS ÉLÉMENT D'INSTALLATION

8



■ 9.02

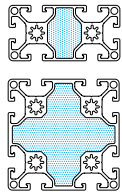

■ 9.03

10

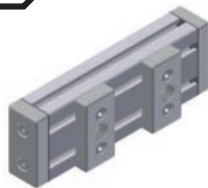

■ 9.04

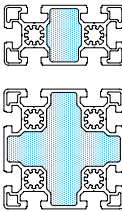

■ 9.05



■ 9.06

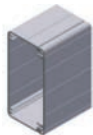

■ 9.06

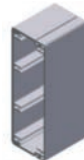

■ 9.06

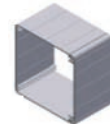

■ 9.07



■ 9.07



■ 9.07



■ 9.08

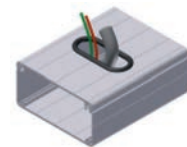

■ 9.09



■ 9.10



■ 9.10

9

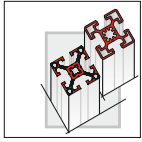

LUFTFÜHRUNGSELEMENTE 40
AIR SUPPLY ELEMENTS 40
CONDUITE D'AIR COMPRIME 40



Anwendung

Application · Application

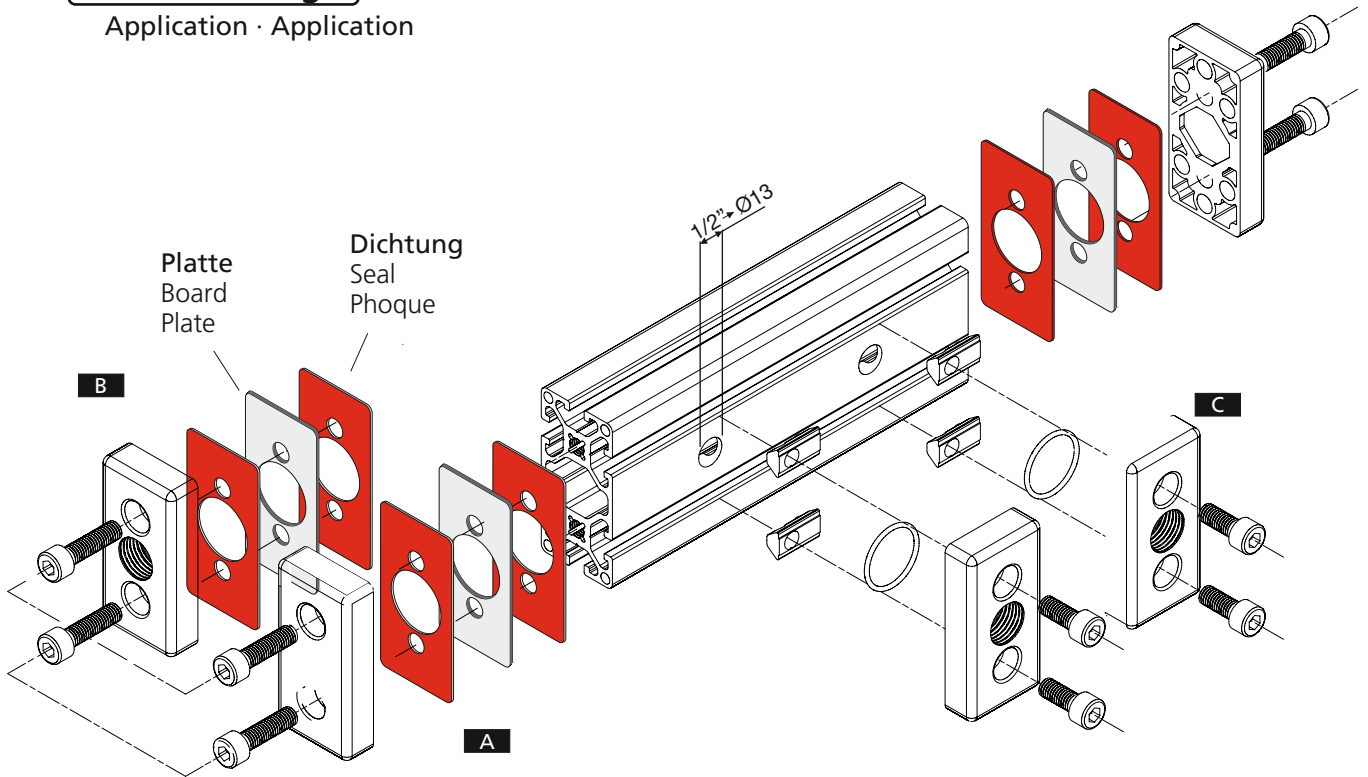

max. 8 bar

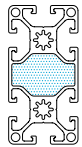

6.8 cm²

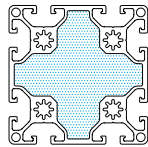

27 cm²



max. 10 bar

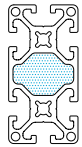

6.3 cm²

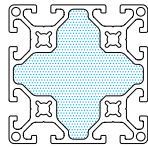

26.7 cm²

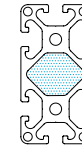

5.7 cm²

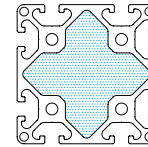

25.4 cm²



max. 12 bar

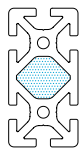

5.1 cm²

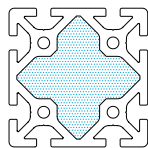

24.6 cm²

Technische Änderungen vorbehalten

LUFTFÜHRUNGSELEMENTE 40

AIR SUPPLY ELEMENTS 40

CONDUITE D'AIR COMPRIE 40



40x80

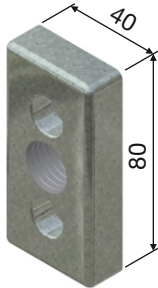

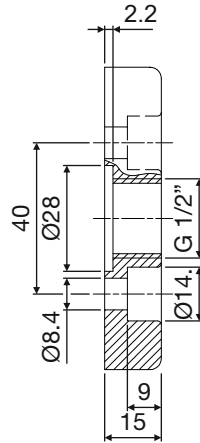

GD-Zn





Platte
Board
Plate  **05.01570.00**

Dichtung
Seal
Phoque  **05.00796.00**

A  +  **05.00791.10**
2x

B  +  **05.00799.10**
2x

C  +  **05.00799.20**
2x

80x80

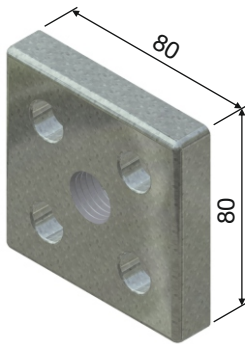

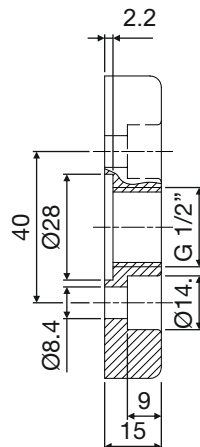

GD-Zn



Platte
Board
Plate  **05.02374.00**

Dichtung
Seal
Phoque  **05.00801.00**

A  +  **05.00793.10**
4x

B  +  **05.00800.10**
4x

C  +  **05.00800.20**
4x

Reduzierstück

Adapter · Réducteur

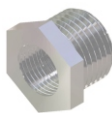

SW24

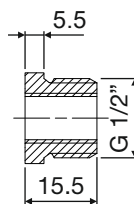

1/2" → 3/8" **05.00750.00**

1/2" → 1/4" **05.00751.00**

1/2" → 1/8" **05.00752.00**

Verschlussstück

Seal · Obturateur

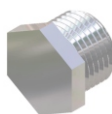

SW24

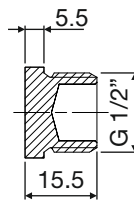

1/2" **05.00753.00**

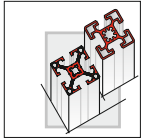

LUFTFÜHRUNGSELEMENTE 45

AIR SUPPLY ELEMENTS 45

CONDUITE D'AIR COMPRIME 45



45

10

Anwendung

Application · Application

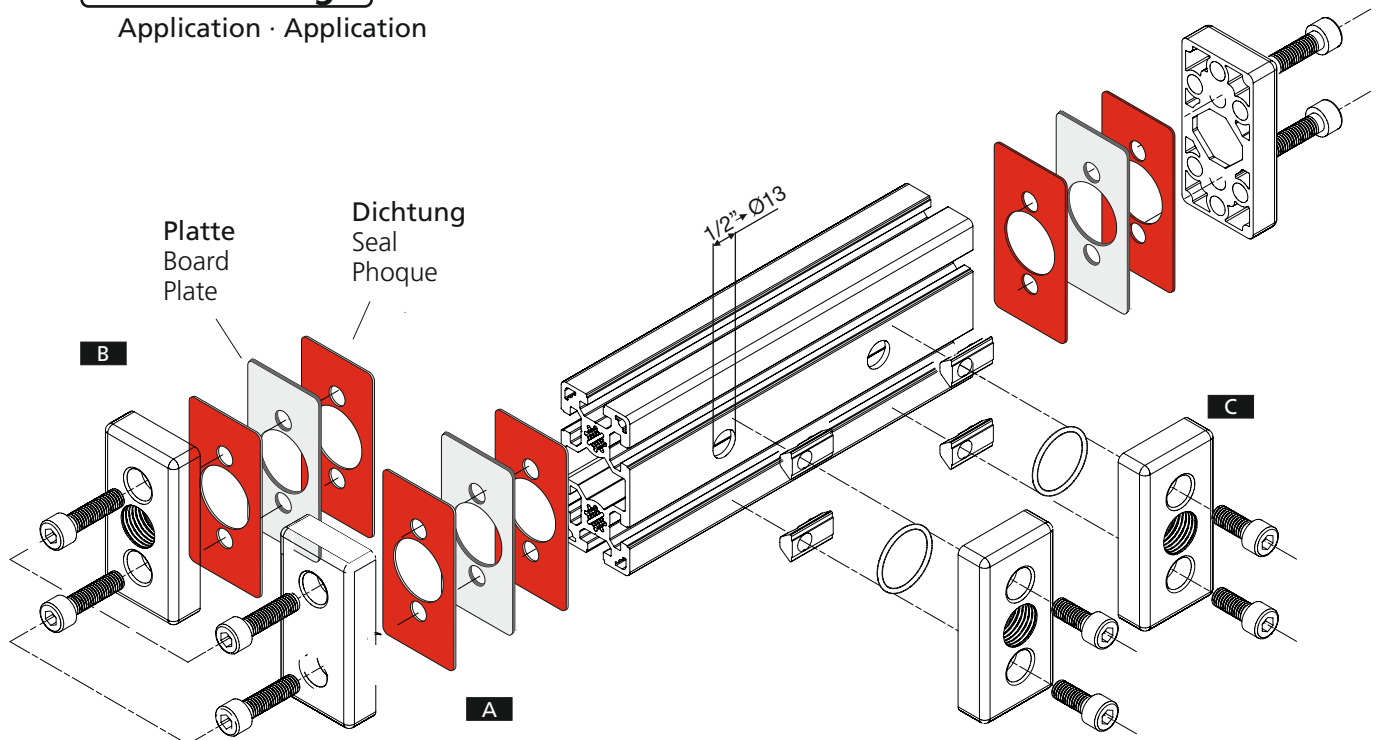

L
45

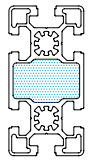

9.3 cm²

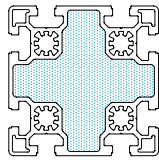

34.7 cm²

max. 8 bar

S
45

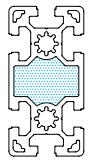

8.8 cm²

max. 12 bar

LUFTFÜHRUNGSELEMENTE 45

AIR SUPPLY ELEMENTS 45

CONDUITE D'AIR COMPRIE 45



45x90

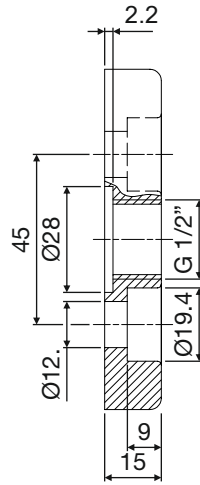
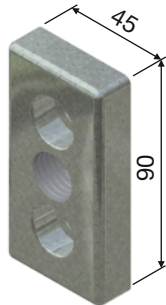

Platte Board Plate **05.01571.12**

Dichtung Seal Phoque **05.00759.00**

A + **05.00755.10**
2x

B + **05.00757.10**
2x

C + **05.00757.20**
2x

90x90

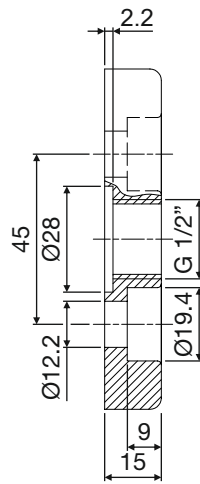
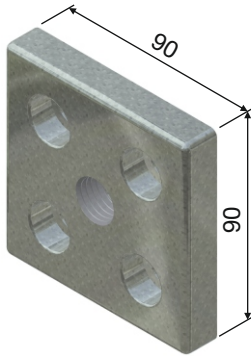

Platte Board Plate **05.02375.00**

Dichtung Seal Phoque **05.00760.00**

A + **05.00756.10**
4x

B + **05.00758.10**
4x

C + **05.00758.20**
4x

Reduzierstück

Adapter · Réducteur

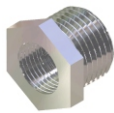

SW24

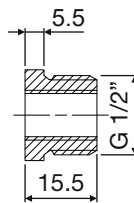

1/2" → 3/8" **05.00750.00**

1/2" → 1/4" **05.00751.00**

1/2" → 1/8" **05.00752.00**

Verschlussstück

Seal · Obturateur

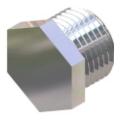

SW24

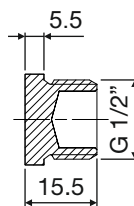

1/2" **05.00753.00**

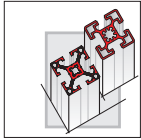

KABELKANALPROFILE

CABLE DUCT PROFILE

PROFILE D`CANIVEAU



40x40

A

05.02025.00

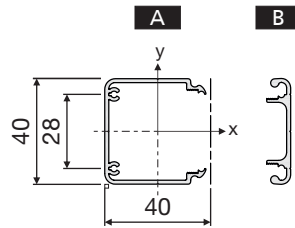

M = 0.53 kg/m
 $I_x = 5.16 \text{ cm}^4$
 $W_x = 2.58 \text{ cm}^3$
 $I_y = 3.10 \text{ cm}^4$
 $W_y = 1.55 \text{ cm}^3$

PE (m)
 6 / 24 / 48

B

05.02026.00



M = 0.30 kg/m
 $I_x = 1.95 \text{ cm}^4$
 $W_x = 0.97 \text{ cm}^3$
 $I_y = 0.06 \text{ cm}^4$
 $W_y = 0.04 \text{ cm}^3$

PE (m)
 6 / 24 / 48

40x80

C

05.02027.00

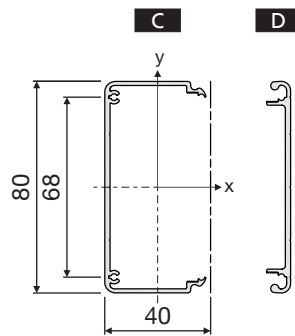
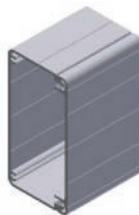

M = 0,78 kg/m
 $I_x = 27,11 \text{ cm}^4$
 $W_x = 6,77 \text{ cm}^3$
 $I_y = 4,03 \text{ cm}^4$
 $W_y = 2,01 \text{ cm}^3$

PE (m)
 6 / 12 / 24 / 48

D

05.02028.00



M = 0.54 kg/m
 $I_x = 13.24 \text{ cm}^4$
 $W_x = 3.31 \text{ cm}^3$
 $I_y = 0.08 \text{ cm}^4$
 $W_y = 0.05 \text{ cm}^3$

PE (m)
 6 / 12 / 24 / 48

40x120

E

05.02214.00

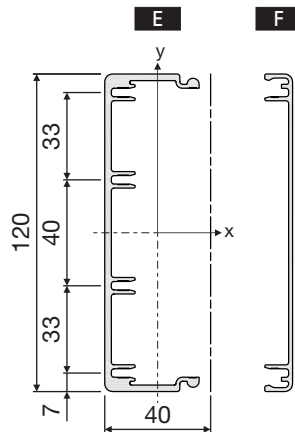

M = 1.60 kg/m
 $I_x = 115.69 \text{ cm}^4$
 $W_x = 19.28 \text{ cm}^3$
 $I_y = 5.43 \text{ cm}^4$
 $W_y = 2.72 \text{ cm}^3$

PE (m)
 3 / 30

F

05.02216.00



M = 0.66 kg/m
 $I_x = 40.69 \text{ cm}^4$
 $W_x = 6.78 \text{ cm}^3$
 $I_y = 0.16 \text{ cm}^4$
 $W_y = 0.10 \text{ cm}^3$

PE (m)
 3 / 30

Technische Änderungen vorbehalten

KABELKANALPROFILE

CABLE DUCT PROFILE

PROFILE D`CANIVEAU



80x80

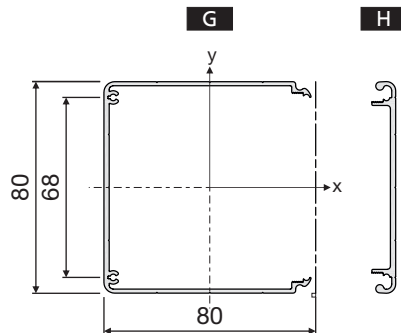
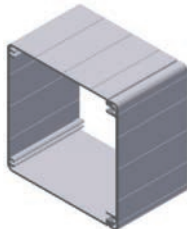

G



05.02029.00

M = 1.10 kg/m
 $I_x = 45.47 \text{ cm}^4$
 $W_x = 11.37 \text{ cm}^3$
 $I_y = 27.85 \text{ cm}^4$
 $W_y = 6.96 \text{ cm}^3$

PE (m)
 6 / 24 / 48

H



05.02028.00

M = 0.54 kg/m
 $I_x = 13.24 \text{ cm}^4$
 $W_x = 3.31 \text{ cm}^3$
 $I_y = 0.08 \text{ cm}^4$
 $W_y = 0.05 \text{ cm}^3$

PE (m)
 6 / 24 / 48

80x120

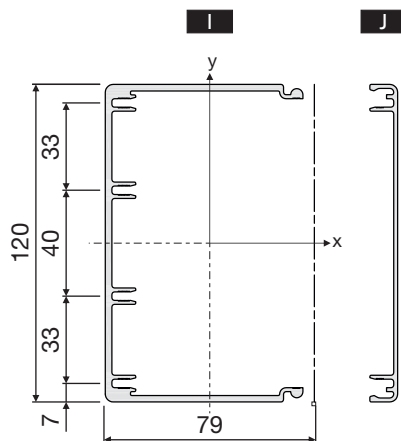

I



05.02215.00

M = 2.12 kg/m
 $I_x = 182.32 \text{ cm}^4$
 $W_x = 30.39 \text{ cm}^3$
 $I_y = 42.56 \text{ cm}^4$
 $W_y = 10.64 \text{ cm}^3$

PE (m)
 3 / 30

J



05.02216.00

M = 0.66 kg/m
 $I_x = 40.69 \text{ cm}^4$
 $W_x = 6.78 \text{ cm}^3$
 $I_y = 0.16 \text{ cm}^4$
 $W_y = 0.10 \text{ cm}^3$

PE (m)
 3 / 30

80x160

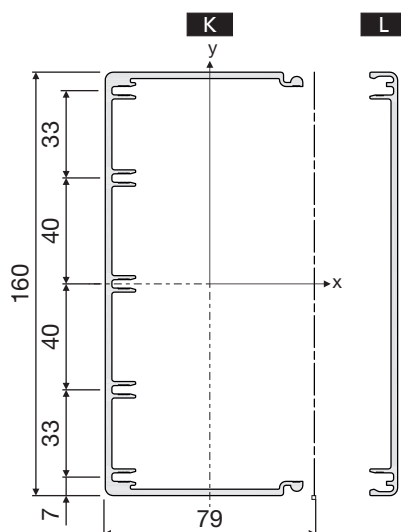
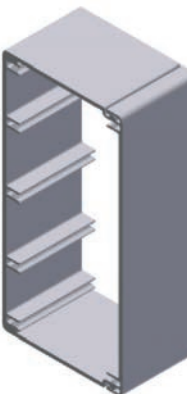

K



05.02217.00

M = 2.43 kg/m
 $I_x = 349.85 \text{ cm}^4$
 $W_x = 43.73 \text{ cm}^3$
 $I_y = 45.36 \text{ cm}^4$
 $W_y = 11.34 \text{ cm}^3$

PE (m)
 3 / 30

L



05.02218.00

M = 1.19 kg/m
 $I_x = 109.37 \text{ cm}^4$
 $W_x = 13.67 \text{ cm}^3$
 $I_y = 0.18 \text{ cm}^4$
 $W_y = 0.10 \text{ cm}^3$

PE (m)
 3 / 30

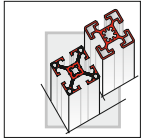

KABELKANAL ABDECKKAPPEN
CABLE DUCT COVERING CAP
CANIVEAU CLAPET DE COUVERCLE



40x40

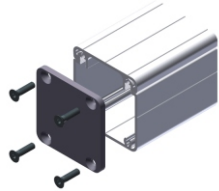

DIN 7991
M3x8 (4x)

99.00500.00

St, vz. 3 mm

05.02219.00

VA 3 mm

05.02219.10

40x80

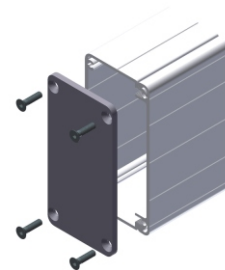

DIN 7991
M3x8 (4x)

99.00500.00

St, vz. 3 mm

05.02222.00

VA 3 mm

05.02222.10

40x120

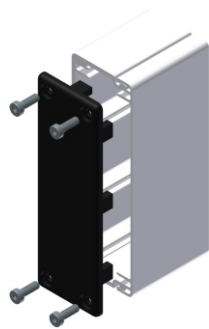

DIN 7984
M4x12 (4x)

99.00095.00

PA, 4 mm

05.02269.00

80x80

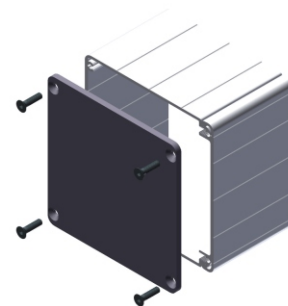

DIN 7991
M3x8 (4x)

99.00500.00

St, vz. 3 mm

05.02268.00

80x120

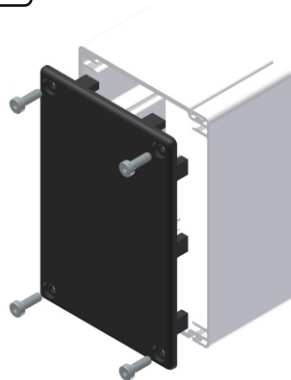

DIN 7984
M4x12 (4x)

99.00095.00

PA, 4 mm

05.02223.00

80x160

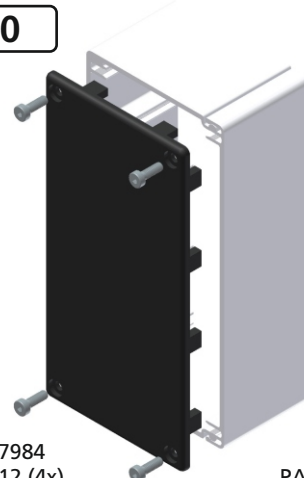

DIN 7984
M4x12 (4x)

99.00095.00

PA, 4 mm

05.02224.00

KABELDURCHFÜHRUNGEN

CABLE BUSHING

PASSE-CABLES



Innovative Vorteile

- Einfaches Verlegen von Leitungen
- Deckt scharfe Schnittkanten ab
- Geschützte Ausleitung von Kabeln und Schläuchen
- Typ B und Typ D für nachträglichen Leitungseinbau geeignet

Innovative advantages

- Easy laying of cables
- Covers sharp edges
- Protected outlet of cables and hoses
- Type B and type D for later cable installation

Atouts novateurs

- Pose aisée de câbles
- Sécurise les arêtes
- Sortie protégée de câbles et flexibles
- Type B et type D pour installation ultérieure de câbles

Typ A

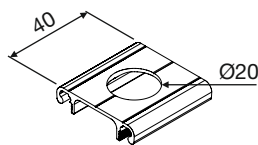
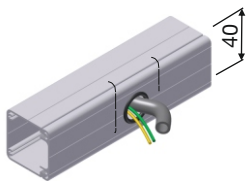

05.02156.00

Typ B

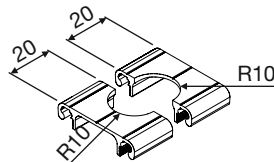
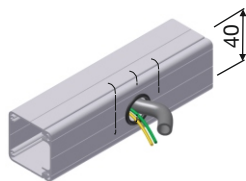

05.02157.00

Für nachträglichen Einbau geeignet

Suitable for retrofitting

Adapté pour montage ultérieur

Typ C

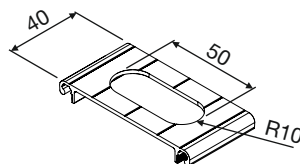
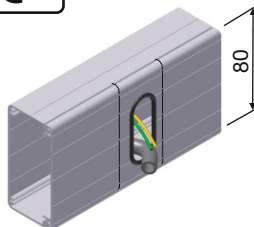

05.02158.00

Typ D

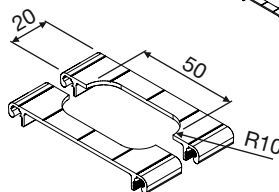
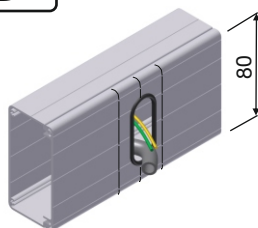

05.02159.00

Für nachträglichen Einbau geeignet

Suitable for retrofitting

Adapté pour montage ultérieur

Typ E

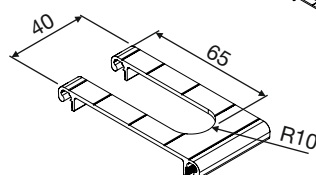
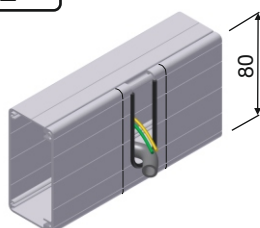

05.02160.00

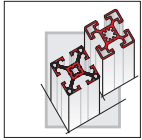

INSTALLATIONSELEMENTE INSTALLATION ELEMENTS ÉLÉMENT D'INSTALLATION



Kabelhalter

Cable holder · Porte-câbles

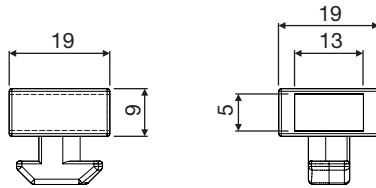

8 05.01528.00

Kunststoff PA,
glasfaserverstärkt
Plastic PA,
fibreglass reinforced
Plastique PA,
renforcé fibres de verre

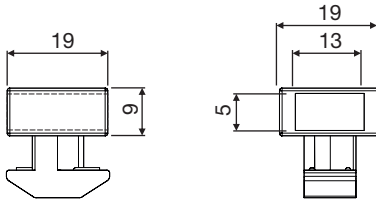

10 05.01530.00

Kunststoff PA,
glasfaserverstärkt
Plastic PA,
fibreglass reinforced
Plastique PA,
renforcé fibres de verre

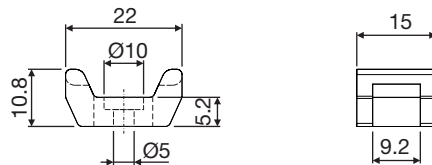

05.01531.00

Kunststoff PA,
glasfaserverstärkt
Plastic PA,
fibreglass reinforced
Plastique PA,
renforcé fibres de verre

IR-Quick

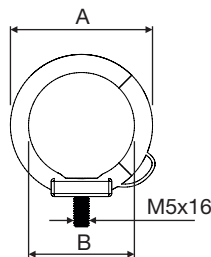

	A	B	
IR-Quick 15F - S	28.5	17	05.01264.00
IR-Quick 25F - S	36.5	25	05.01265.00
IR-Quick 35F - S	47.5	35	05.01266.00
IR-Quick 45F - S	56.5	45	05.01267.00

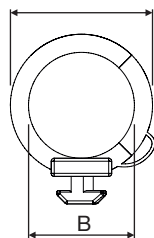

8	A	B	
IR-Quick 15F - 8	28.5	17	05.01275.00
IR-Quick 25F - 8	36.5	25	05.01276.00
IR-Quick 35F - 8	47.5	35	05.01277.00
IR-Quick 45F - 8	56.5	45	05.01278.00

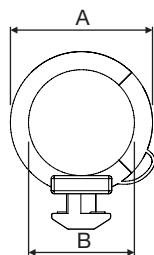

10	A	B	
IR-Quick 15F - 10	28.5	17	05.01260.00
IR-Quick 25F - 10	36.5	25	05.01261.00
IR-Quick 35F - 10	47.5	35	05.01262.00
IR-Quick 45F - 10	56.5	45	05.01263.00

Technische Änderungen vorbehalten

ECO-ROHRSTECKSYSTEM

ECO PIPE SYSTEM

TUBES ECO



Das System für Ihren **KVP**:
Kontinuierlichen
Verbesserungs
Prozess
und Ihre Kanban-Systeme als Lösung
Ihrer Logistik-Prozesse

Merkmale

- Einfache Planung
- Wenige Werkzeuge
- Leichte Montage
- Flexible Erweiterungen
- Wiederverwendbarkeit der Produkte
- Umweltfreundliche Produkte
- Anbindung an das FM-Aluprofil-system

The system for your **CIP**:
Continuous
Improvement
Process
and the Kanban systems as solution
for your logistics processes

Characteristics

- Easy planning
- Less tools
- Easy assembly
- Flexible extension
- Reusability of the products
- Environmentally friendly products
- Connection to the FM aluminium profile system

Le système pour
Processus
D'optimisation
Continue
et vos systèmes de gestion des stocks
FIFO (PEPS)

Caractéristique

- Etude simplifiée
- Peu d'outils
- Montage aisé
- Modularité
- Réutilisation illimitée
- Respect de l'environnement
- Compatible avec le système de profilés alu FM



■ 10.02



■ 10.03



■ 10.04

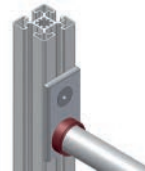

■ 10.06



Für mehr Informationen
bitte separaten Katalog
anfordern!

ECO-Rohr

Please request separate
catalogue for more
information!

ECO-Rohr

Pour plus d'informations,
demandez notre catalogue
détaillé!

ECO-Rohr

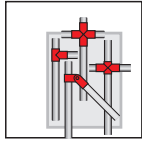

ECO-ROHRSTECKSYSTEM

ECO PIPE SYSTEM

TUBES ECO



Artikel Nr. Item No. Article No.	Typ Type Typé	Ø mm	t mm	Farbe Colour Couleur	Gewicht Weight Poids	HV
08.00010.00	KUMA-Rohr	28	1	Lichtgrau Light grey Gris clair	0.73 kg/m	90
08.00017.00	KUMA-Rohr	28	1	Dunkelgrau Dark grey Gris foncé	0.73 kg/m	90
08.00016.00	KUMA-Rohr	28	1	Enzianblau Blue (dark) Bleu (noir)	0.73 Kg/m	90
08.00004.00	KUMA-Rohr	28	1	Weiß White Blanc	0.73 Kg/m	90
08.00314.00	KUMA-Rohr	28	1	Rot Red Rouge	0.73 Kg/m	90
08.00315.00	KUMA-Rohr	28	1	Gelb Yellow Jaune	0.73 Kg/m	90
08.00011.00	KUMA-Rohr	28	1	Grün Green Vert	0.73 Kg/m	90
08.00008.00	KUMA-Rohr	28	2	Lichtgrau Light grey Gris clair	1.35 kg/m	90
08.00018.00	KUMA-Rohr	28	2	Dunkelgrau Dark grey Gris foncé	1.35 kg/m	90
08.00007.00	KUMA-Rohr	28	2	Enzianblau Blue (dark) Bleu (noir)	1.35 kg/m	90
08.00005.00	KUMA-Rohr	28	2	Weiß White Blanc	1.35 kg/m	90
08.00013.00	KUMA-ESD	28	1	Schwarz Black Noir	0.72 kg/m	90
08.00029.00	KUMA-ESD Winkelrohr	28	1	Schwarz Black Noir	0.77 kg/m	90
08.00021.00	KUMA-ESD	28	2	Schwarz Black Noir	1.35 kg/m	90
08.00022.00	KUMA-Rohr	28	2	Rot Red Rouge	1.35 kg/m	90
08.00026.00	KUMA- Gleit-Rohr	28	1	Enzianblau Blue (dark) Bleu (noir)	0.77 kg/m	90
08.00027.00	KUMA- Gleit-Rohr	28	1	Lichtgrau Light grey Gris clair	0.77 kg/m	90
08.00003.00	KUMA- Gleit-Rohr	28	2	Lichtgrau Light grey Gris clair	1.35 kg/m	90
08.00009.00	KUMA-ESD Gleit-Rohr	28	1	Schwarz Black Noir	0.77 kg/m	90
08.00019.00	KUMA-ESD Flach-Rohr	28	1	Schwarz Black Noir	0.77 kg/m	90
08.00019.10	KUMA Flach-Rohr	28	1	Grau grey Gris	0.77 kg/m	90
08.00020.00	KUMA-Rohr	32	1	Lichtgrau Light grey Gris clair	0.87 kg/m	90
08.00001.00	NICO	28	0.8	Silber Silver Argent	0.55 kg/m	210
08.00002.00	NICO	28	1.2	Silber Silver Argent	0.79 kg/m	210
08.00023.00	NICO	32	0.8	Silber Silver Argent	0.66 kg/m	210

Technische Änderungen vorbehalten

KUMA-ROHR

KUMA PIPE · TUBE KUMA

Stahlrohr mit Kunststoffmantel (ABS)
Steel pipe with ABS resin
Tube acier avec revêtement ABS

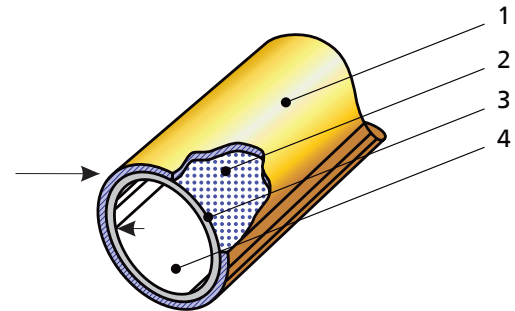

- | | |
|--|---|
| 1 ABS-Mantel
ABS resin
Revêtement ABS | 2 Stahlrohr-Oberfläche
Steel Surface
Surface du tube acier |
| 3 Stahlrohr
Steel pipe
Tube acier | 4 Rostfrei-Beschichtung
Anti rust painting
Revêtement inoxydable |

NICO-ROHR

NICO PIPE · TUBE NICO

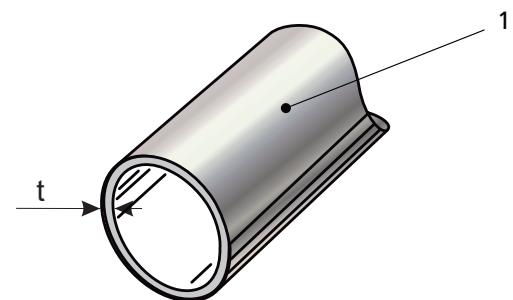

- 1** Stahlrohr, hoch glänzend
mit Indoor-Korrosionsschutz
Steel pipe, bright with Indoor-
corrosion protection
Tube acier, brillant avec
Indoor protection anticorrosion

PUNKTLAST

Single statically stress · Charge statique max

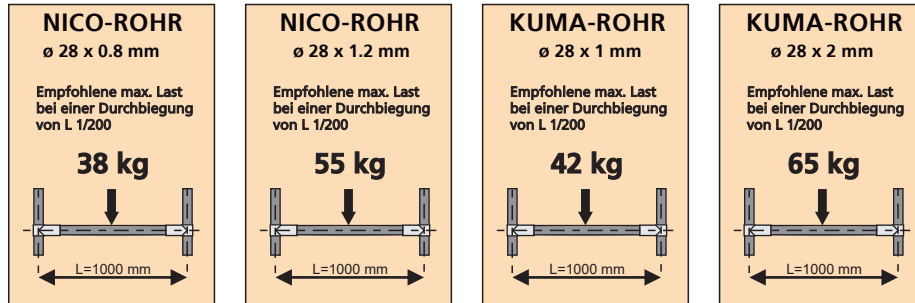

STRECKENLAST

Surface statically stress · Charge au mètre linéaire

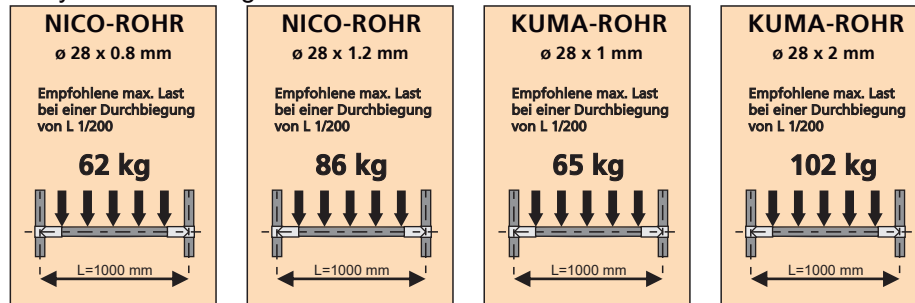

Zulässige Verbinderbelastungen

Permitted connector loads · Charges admissibles des fixations

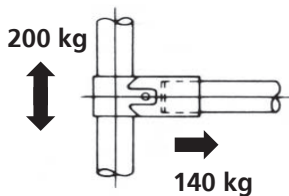

Max. ruhende Last horizontal und vertikal

Max. resting load, horizontal and vertical

Charge statique max. sur la fixation maximale et horizontale

Planung der Rohrlängen Ø28

Planning of pipe lengths Ø28 · Etude des cotes Ø28

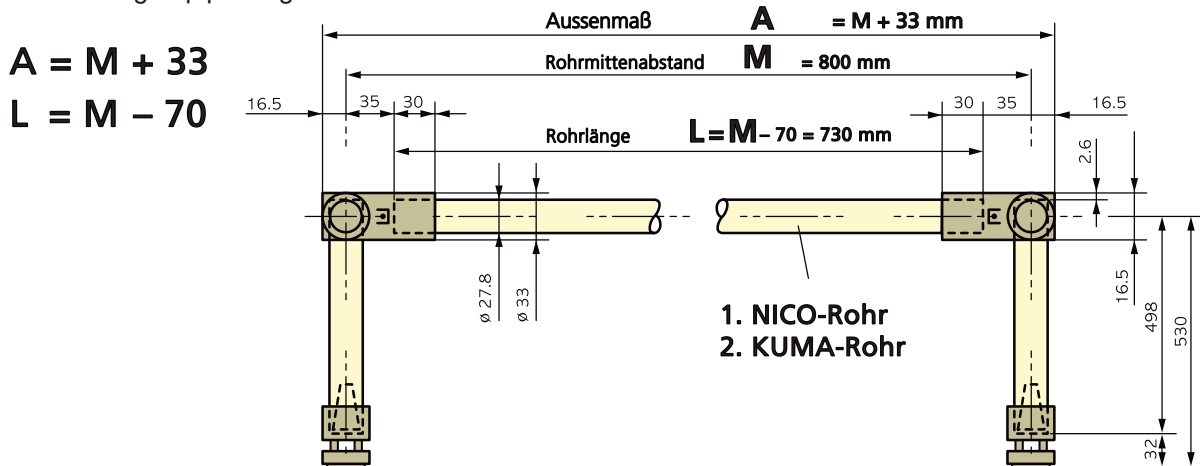

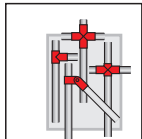

ECO-ROHRSTECKSYSTEM VERBINDER

ECO PIPE SYSTEM CONNECTOR

KITS DE FIXATION ECO-MECANO



Rohr-T-Verbinder

Pipe T-connector · Fixation droite

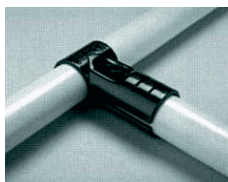
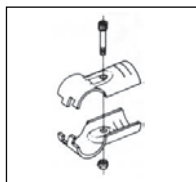

Ø 28 mm

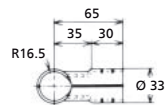

HJ-1

08.00030.xx

Ø 32 mm

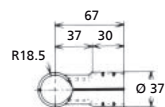

WJ-1

08.00031.xx

Rohr-Eckverbinder

Pipe corner connector · Fixation d'angle

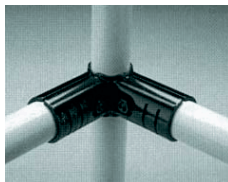
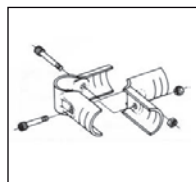

Ø 28 mm

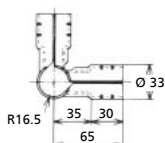

HJ-2

08.00032.xx

Ø 32 mm

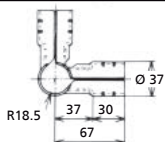

WJ-2

08.00033.xx

Rohr-T-Kreuzverbinder

Pipe T cross-connector · Connecteur en T

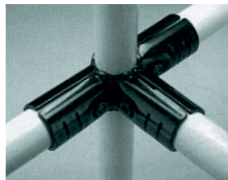
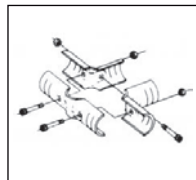

Ø 28 mm

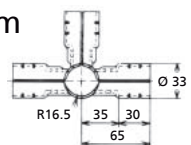

HJ-3

08.00034.xx

Ø 32 mm

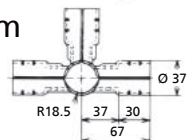

WJ-3

08.00035.xx

Rohr-Kreuzverbinder

Pipe cross connector · Fixation croisée

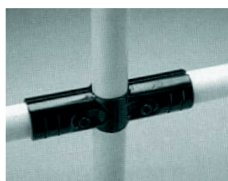
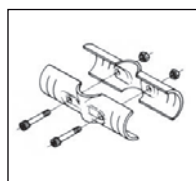

Ø 28 mm

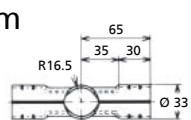

HJ-4

08.00036.xx

Ø 32 mm

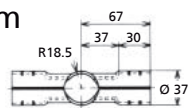

WJ-4

08.00037.xx

Rohr-Sternverbinder

Pipe star connector · Fixation étoile

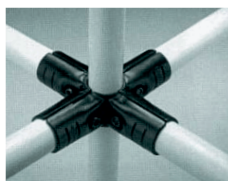
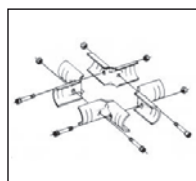

Ø 28 mm

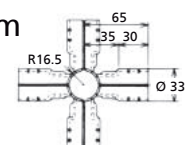

HJ-5

08.00038.xx

Ø 32 mm

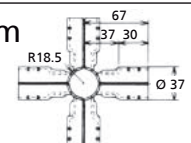

WJ-5

08.00039.xx

Technische Änderungen vorbehalten

08.00xxx.00

silber-vernickelt

silver nickel-plated · nickelé argent

08.00xxx.10

schwarz-chromatiert

black chrome · chromatisé noir

ECO-ROHRSTECKSYSTEM VERBINDER

ECO PIPE SYSTEM CONNECTOR

KITS DE FIXATION ECO-MECANO



Rohr-Kreuzverbinder HV

Pipe cross connector HV · Fixation croisée HV

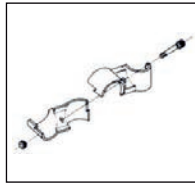

Ø 28 mm

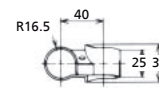

HJ-6

08.00040.xx

Ø 32 mm

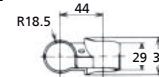

WJ-6

08.00041.xx

Rohr-Gelenkverbinder

Pipe hinged connector · Fixation articulée

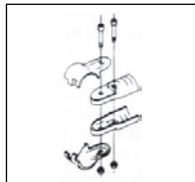

Ø 28 mm

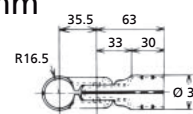

HJ-7

08.00042.xx

Ø 32 mm

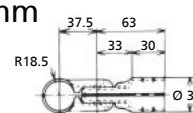

WJ-7

08.00043.00

Rohr-T-Parallelverbinder

Pipe T parallel connector · Fixation T parallèle

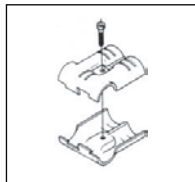

Ø 28 mm

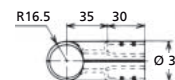

HJ-9

08.00044.xx

Rohr-Parallelverbinder

Pipe parallel connector · Fixation parallèle

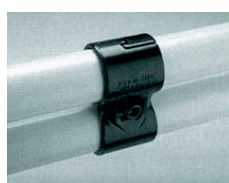
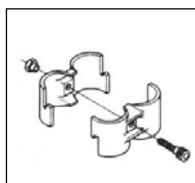

Ø 28 mm

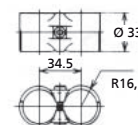

HJ-10

08.00046.xx

Ø 28 mm

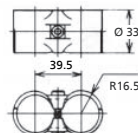

HJ-12

08.00050.00

Rohr-Sternverbinder

Pipe star connector · Fixation étoile

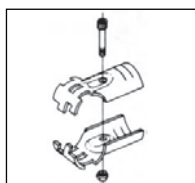

Ø 28 mm

HJ-11

08.00048.xx

08.00xxx.00

silber-vernickelt

silver nickel-plated · nickelé argent

08.00xxx.10

schwarz-chromatiert

black chrome · chromatisé noir

Technische Änderungen vorbehalten

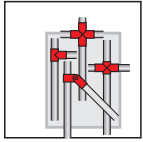

ECO-ROHRSTECKSYSTEM VERBINDER

ECO PIPE SYSTEM CONNECTOR

KITS DE FIXATION ECO-MECANO



Einfach das ECO-Rohrstecksystem mit dem Aluminiumsystem kombinieren, so können Sie die Vorteile beider Systeme nutzen.

Easy to connect the ECO-pipe system with the Alu profile system. So you can use all the advantages from both systems.

Il vous suffit d'associer le système de tubes ECO au système de profilés en aluminium pour profiter des avantages des deux systèmes.

VS - Verbindung

Artikel Nr.	TYP	Ø	□	U
08.00399.00	ALU / NICO / KUMA 1mm	28	40	8
08.00399.00	ALU / NICO / KUMA 1mm	28	45	10

Winkelverbindung

Artikel Nr.	TYP	Ø	A	□	U
08.00398.05	ALU / NICO / KUMA 1mm	28	16	40	8
08.00398.05	ALU / NICO / KUMA 1mm	28	13.5	45	10

Technische Änderungen vorbehalten

ECO-ROHRSTECKSYSTEM ZUBEHÖR

ECO PIPE SYSTEM ACCESSORIES

ECO MECANO ACCESSOIRES



Rohr Profil T - teilbare Verbindungen

Artikel Nr.	TYP	Ø	A		
08.00400.00	NICO / KUMA 1/2 mm	28	35	40/45	

INFO

Rohr Profil T - feste Verbindungen

Artikel Nr.	TYP	Ø	A		
08.00153.00	NICO / KUMA 1/2 mm	28	5	40/45	

INFO

Laschenverbindung

Artikel Nr.	TYP		
08.00492.00	KUMA-Rohr ø 28 x 1.0 mm	40/45	
08.00493.00	KUMA-Rohr ø 28 x 2.0 mm	40/45	
08.00494.00	NICO-Rohr ø 28 x 0.8 mm	40/45	
08.00495.00	NICO-Rohr ø 28 x 1.2 mm	40/45	

Profilreihe 40 8
 Profilreihe 45 10

KUMA
 NICO
 ø 28 x 1 mm
 ø 28 x 2 mm
 ø 28 x 0.8 mm
 ø 28 x 1.2 mm

INFO

Einschlagwerkzeug für Federkralle M6
 Driver tool for spring-loaded M6
 Outil d'insertion pour griffes élastiques M6
 Art.Nr.: 08.00496.00

10

Technische Änderungen vorbehalten



Einbau nur in Profilrahmen da begrenzte Auszugsfestigkeit
 Only for installation in profiled frame because of limited extraction force
 Montage seulement dans chasis profilé car résistance au exode

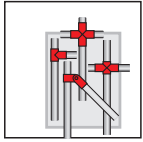

ECO-ROHRSTECKSYSTEM ANWENDUNG
ECO PIPE SYSTEM APPLICATION
APPLICATION ECO-MECANO



Anwendungsbeispiele

Application examples · Exemples d'application

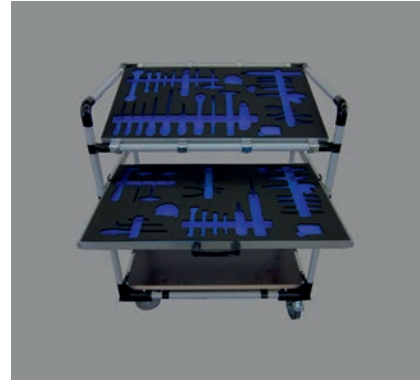

Technische Änderungen vorbehalten



Für mehr Informationen
 bitte separaten Katalog
 anfordern!

ECO-Rohr

Please request separate
 catalogue for more
 information!

ECO-Rohr

Pour plus d'informations,
 demandez notre catalogue
 détaillé !

ECO-Rohr

SCHUTZ- UND TRENNSYSTEME

PROTECTION AND SEPARATING SYSTEMS

SYSTEMES DE PROTECTION DE ZONE

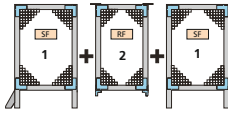

■ 11.02

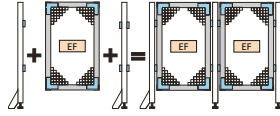

■ 11.06

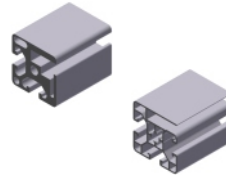

■ 11.05



■ 11.10



■ 11.11



■ 11.12



■ 11.13

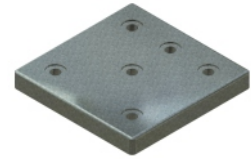

➔ ■ 5.12



➔ ■ 5.13



➔ ■ 8.34

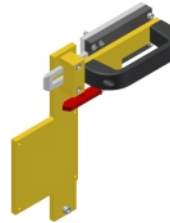

■ 11.24

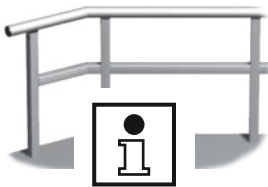

■ 11.19

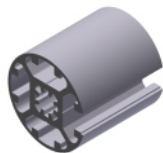

■ 11.20



■ 11.21



■ 11.22



■ 11.23



■ 11.21



■ 11.23

Technische Änderungen vorbehalten

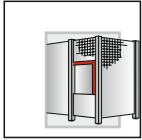

SCHUTZZAUNSYSTEM RB

PROTECTION FENCE SYSTEM RB

SYSTEME DE PROTECTION RB



Prinzipskizze

Sketch of principle · Esquisse de principe

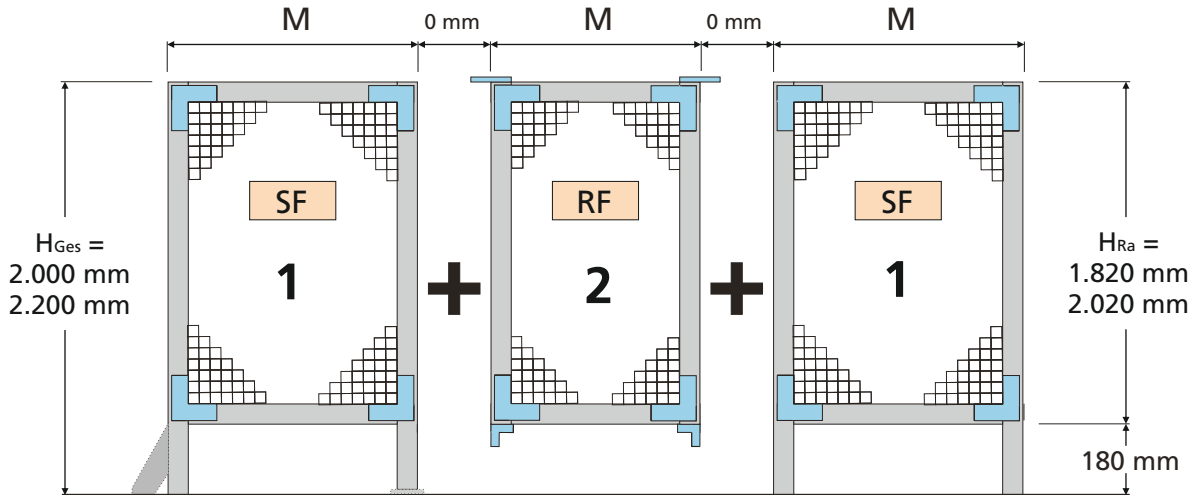

● Einfache Montage

Simple building method
Construction plus simple

● Günstigeres System

The beneficial system
Le system plus favorable

● Kein Spaltmaß

No gap
Pas d'écart

Merkmale

- Minimaler konstruktiver Aufwand durch Rasterbreiten
- Komplett vormontierte Ständerfelder (SF) und Rahmenfelder (RF)

Größen:

Standardhöhe: H = 2.000 mm
Optional: H = 2.200 mm

Breiten ab Lager:

M = 750 / 1.000 / 1.250 / 1.500 mm

Rasterbreiten:

M = 300 – 2.000 mm im 50 mm Raster

Flächenelement:

Basiselement:

Verzinktes Wellgitter
40 x 40 x 4 mm

Characteristics

- **Simple** assembly system and Building method
- Stand fields (SF) and suspension fields (RF) are completely preassembled

Dimensions:

Standard height: H = 2.000 mm
Possibility: H = 2.200 mm

Width from stock:

M = 750 / 1.000 / 1.250 / 1.500 mm

Standard width:

From M = 300 - 2.000 mm with 50 mm of distance

Dimensional element:

Standard element:

Waving lattice 40 x 40 x 4 mm, galvanized

Caracteristiques

- Assemblage et construction **plus simple**
- Les panneaux principaleaux (SF, RF) sont **prémontés**

Dimensions:

Longueur standard : H = 2.000 mm
Option : H = 2.200 mm

Largeur pris en magasin :

M = 750 / 1.000 / 1.250 / 1.500 mm

Largeur standard :

De M = 300 - 2.000 mm est d'une distance 50 mm

Élément de surface :

Élément standard :

Grille ondulée, zinguée
40 x 40 x 4 mm

SCHUTZZAUNSYSTEM RB
PROTECTION FENCE SYSTEM RB
SYSTEME DE PROTECTION RB

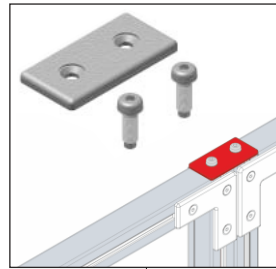
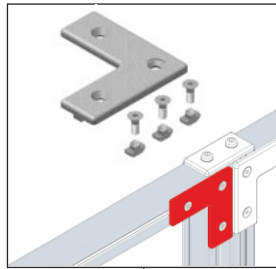
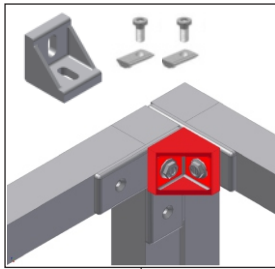

➔ ■ 3.24

➔ ■ 3.24

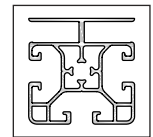
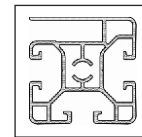
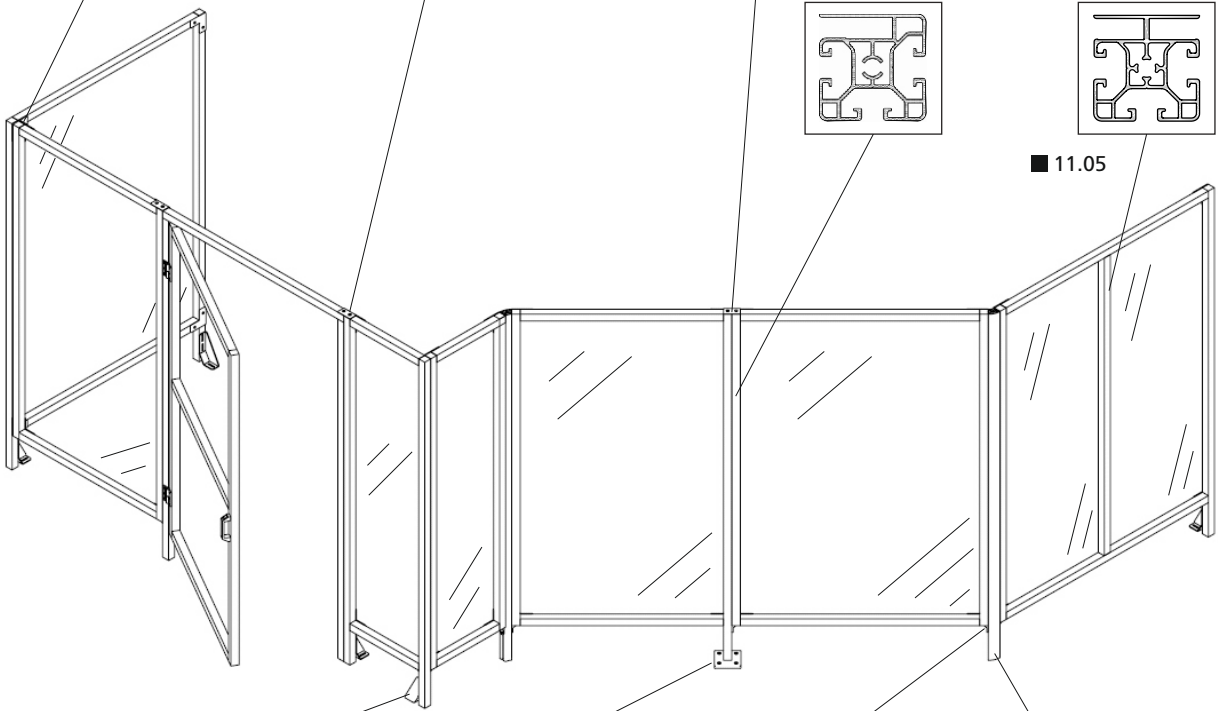

■ 11.05

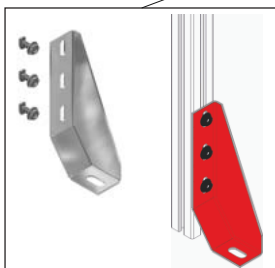

➔ ■ 5.09

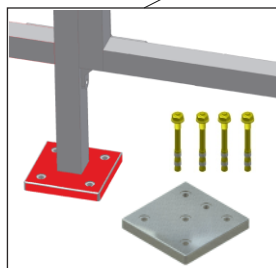

➔ ■ 5.12

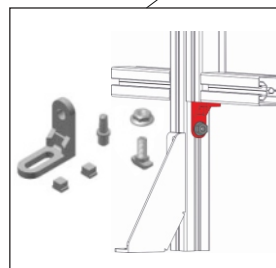

■ 11.12

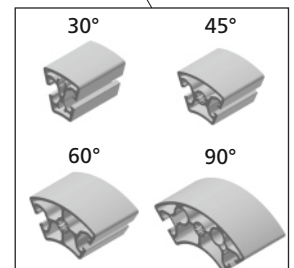

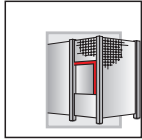

SCHUTZZAUNSYSTEM RB

PROTECTION FENCE SYSTEM RB

SYSTEME DE PROTECTION RB



Ständerfelder - SF

Stand fields (SF) · Panneaux (SF)

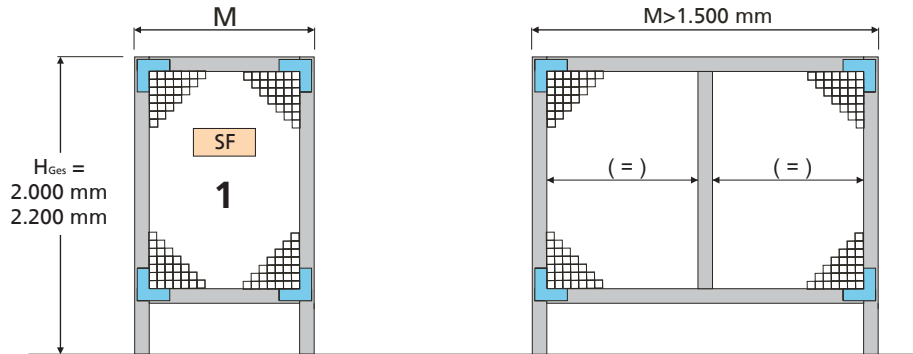

SF ab Lager · Width from stock · Largeur pris en magasin

H _{Ges}	M (mm)	Art.Nr.
2.000 mm	750	05.05021.12
	1.000	05.05021.17
	1.250	05.05021.22
	1.500	05.05021.27
2.200 mm	750	05.05221.12
	1.000	05.05221.17
	1.250	05.05221.22
	1.500	05.05221.27

Rasterbreiten (50 mm) · Modular width · Largeur modular

H _{Ges}	M	Art.Nr.
2.000 mm	xy	05.05021.xy
2.200 mm	xy	05.05221.xy

$$xy = M : 50 - 3$$

$$\text{Bsp: } M = 800 \text{ mm} \rightarrow xy = 800:50-3 = 11$$

$$300 \text{ mm} \leq M \leq 2000 \text{ mm}$$

Rahmenfelder - RF

Suspensions fields (RF) · Panneaux (RF)

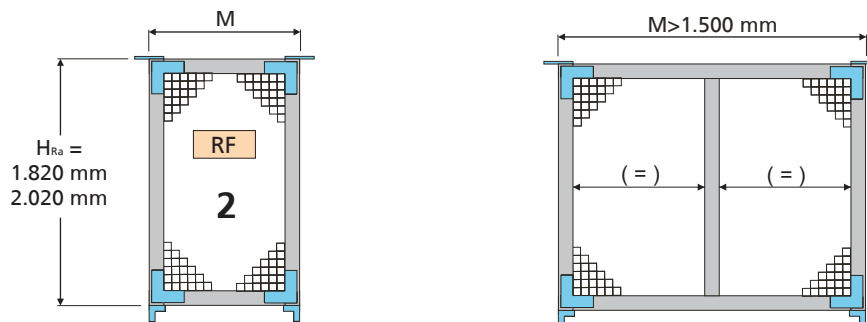

RF ab Lager · Width from stock · Largeur pris en magasin

H _{Ges}	M (mm)	Art.Nr.
2.000 mm	750	05.05022.12
	1.000	05.05022.17
	1.250	05.05022.22
	1.500	05.05022.27
2.200 mm	750	05.05222.12
	1.000	05.05222.17
	1.250	05.05222.22
	1.500	05.05222.27

Rasterbreiten (50 mm) · Modular width · Largeur modular

H _{Ges}	M	Art.Nr.
2.000 mm	xy	05.05022.xy
2.200 mm	xy	05.05222.xy

$$xy = M : 50 - 3$$

$$\text{Bsp: } M = 800 \text{ mm} \rightarrow xy = 800:50-3 = 11$$

$$300 \text{ mm} \leq M \leq 2000 \text{ mm}$$

SCHUTZZAUNPROFILE

PROTECTION FENCE PROFILES

PROFILES DE PROTECTION DE ZONE



Innovative Vorteile

- Einfache Montage ohne Profilbearbeitung
- Stabile Aufnahme der Wellgitter 40x40x4 ohne zusätzliche Klemmelemente
- Steigerung der Stabilität durch FM-Schutzzaunwinkel mit Zentrierfahnen

Innovative advantages

- Easy assembly without profile processing
- Sturdy fastening of corrugated grating 40x40x4 without additional clamping elements
- Additional stability through our protective fence angle brackets with centring lugs

Atouts novateur

- Montage aisé sans usinages
- Maintien du grillage ondulé 40x40x4 optimisé par la profondeur de la rainure
- Stabilité encore accrue par plaques de renfort FM

40x40

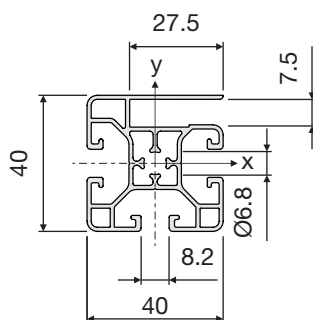
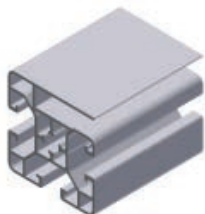

05.02024.00

M = 1.01 kg/m
 $I_x = 6.17 \text{ cm}^4$
 $W_x = 3.09 \text{ cm}^3$
 $I_y = 5.88 \text{ cm}^4$
 $W_y = 2.94 \text{ cm}^3$

PE (m)
 6 / 48 / 96 / 144

40x40 - 180°

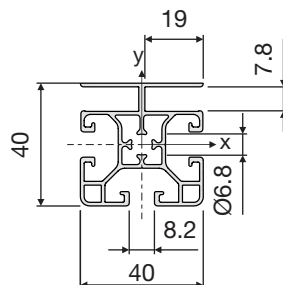
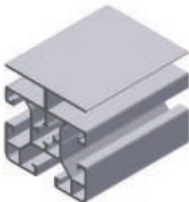

05.02023.00

M = 0.99 kg/m
 $I_x = 6.04 \text{ cm}^4$
 $W_x = 3.02 \text{ cm}^3$
 $I_y = 5.41 \text{ cm}^4$
 $W_y = 2.70 \text{ cm}^3$

PE (m)
 6 / 48 / 96 / 144

Federklemmelement

Spring clamping element · Agrafe à ressort

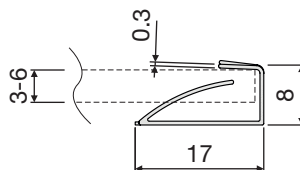
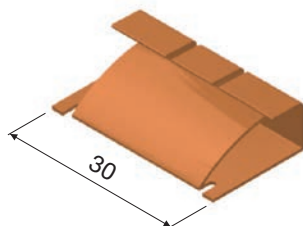

05.02031.00

Federstahl
 Spring steel
 Acier ressort

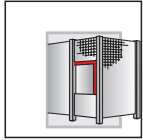

SCHUTZZAUNSYSTEM CLASSIC

PROTECTION FENCE SYSTEM CLASSIC

SYSTEME DE PROTECTION CLASSIC



Prinzipskizze

Sketch of principle · Esquisse de principe

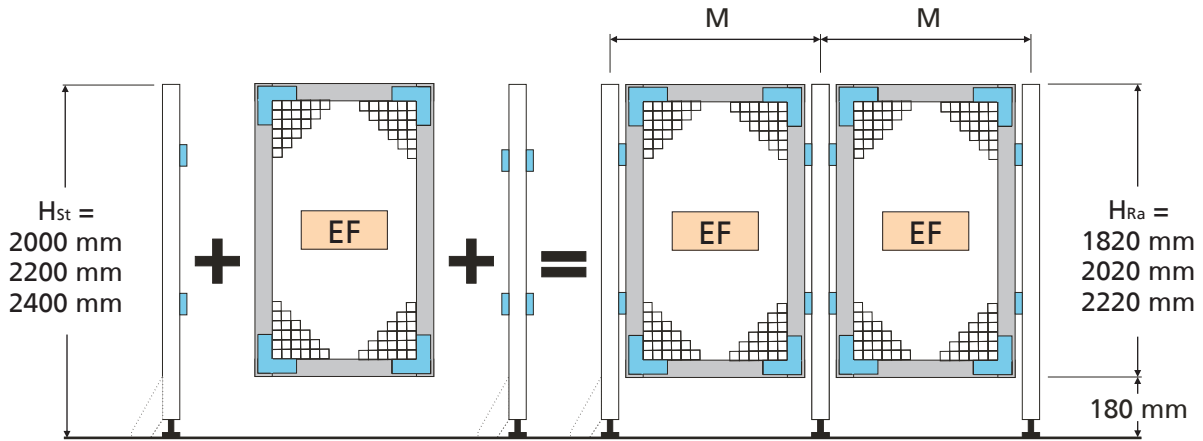

- **Universelle Anordnung**
Universal arrangement
Disposition universelle

- **Vielseitig und variabel**
Multifunctional and variable
Multitâche et variable

- **Automobil-sicherheit**
Automobile security
Sécurité automobile

Merkmale

- Durch spezielle Einhängung schneller Zugang zum geschützten Objekt
- Umfangreiches Zubehörangebot
- Auch mit umlaufender Strebe oben lieferbar

Größen

Standardhöhe: H = 2.000 mm
Optional: H = 2.200 mm
H = 2.400 mm

Breiten ab Lager:
M = 750 / 1.000 / 1.250 / 1.500 mm

Standardbreiten:
M = 300 – 2.000 mm im
50 mm Raster

Flächenelement

Basiselement:
Verzinktes Wellgitter
40x40x4 mm

Characteristics

- Special suspension for faster access to protected object
- Extensive accessories
- Also available with surrounding struts

Dimensions

Standard height: H = 2.000 mm
Possibility: H = 2.200 mm
H = 2.400 mm

Width from stock:
M = 750 / 1.000 / 1.250 / 1.500 mm

Standard width:
From M = 300 - 2.000 mm with
50 mm of distance

Dimensional element

Standard element
Waving lattice 40x40x4 mm,
galvanized

Caracteristique

- Module facilement démontable, accessibilité aisée
- Accessoires gros
- Également disponible avec barre horizontale supérieure

Dimension

Longueur standard : H = 2.000 mm
Option : H = 2.200 mm
H = 2.400 mm

Largeur pris en magasin :
M = 750 / 1.000 / 1.250 / 1.500 mm

Largeur standard :
De M = 300 - 2.000 mm est d'une
distance 50 mm

Élément de surface

Élément standard
Grille ondulée, zinguée
40x40x4 mm

SCHUTZZAUNSYSTEM CLASSIC

PROTECTION FENCE SYSTEM CLASSIC

SYSTEME DE PROTECTION CLASSIC

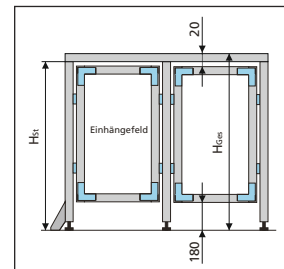
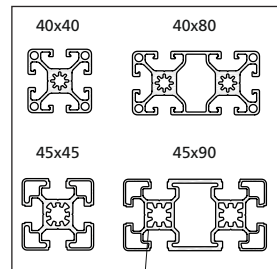
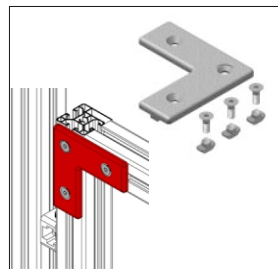
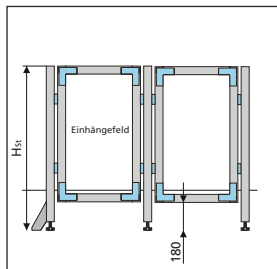

➔ ■ 3.24

➔ ■ 2.01

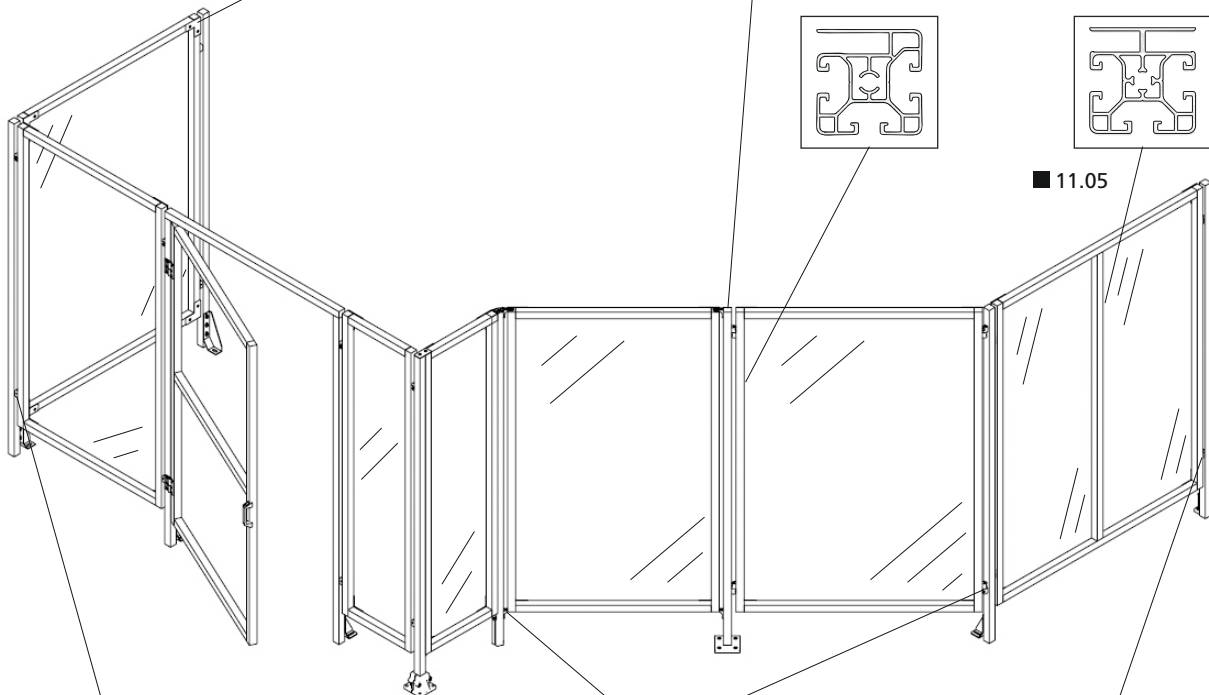

■ 11.05

■ 11.10 S=20-22.5 mm

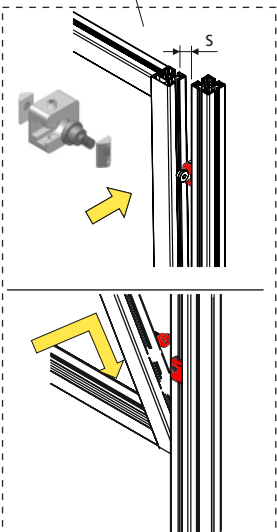

■ 11.11 S=22.5 mm

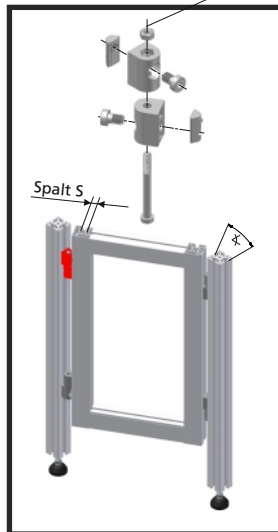

■ 11.12 S=20-22.5 mm

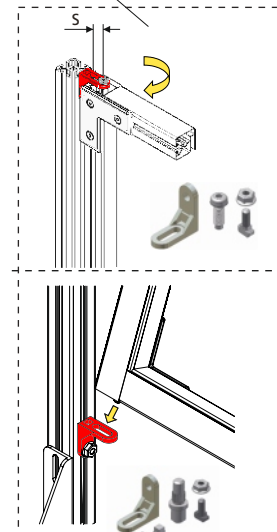

■ 11.13 S=12.5-15 mm

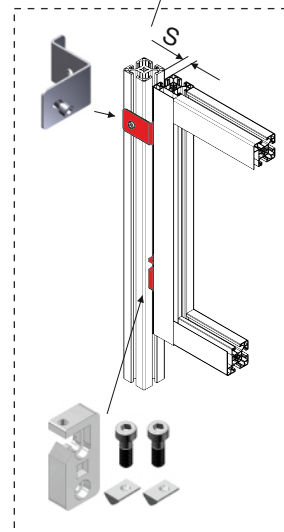

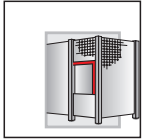

SCHUTZZAUNSYSTEM CLASSIC

PROTECTION FENCE SYSTEM CLASSIC

SYSTEME DE PROTECTION CLASSIC



System-Stützen

Pillar · Piliers

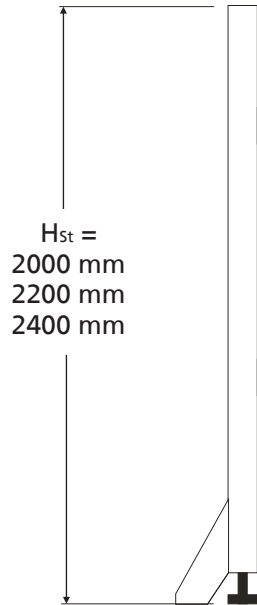

1		40 x 40 L - 1.55 kg/m 05.01035.00
5		40 x 80 L - 2.63 kg/m 05.01036.00
3		45 x 45 L - 1.70 kg/m 05.01041.00
7		45 x 90 L - 2.90 kg/m 05.01518.00

→ ■ 2.01

Typ 1

→ ■ 5.08



Typ 2

→ ■ 5.10



Typ 3

→ ■ 5.12

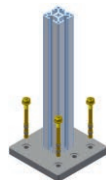

Typ 5



Bestellnummer · Order number · Numéro article

05.05 □ 51. □ □

Fußausführung · Pedestal version · Montage au sol

1 = Typ1

2 = Typ 2

3 = Typ 3

5 = Typ 5

Stützenprofil · Pillar profile · Profile pilier

1 = 40 x 40 L

5 = 40 x 80 L

3 = 45 x 45 L

7 = 45 x 90 L

Stützenhöhe · Profile height · Profile longueur

0 = 2.000 mm

2 = 2.200 mm

4 = 2.400 mm

Bestellbeispiel: 05.05251.33

Stützenhöhe 2.200 mm, Stützenprofil = 45x45 L, Fußausführung = Typ 3

Example for ordering: 05.05251.33

Profile height 2.200 mm, Pillar profile = 45x45 L, Pedestal version = Typ 3

Exemple de commande : 05.05251.33

Profile longueur 2.200 mm, Profile pilier = 45x45 L, Montage au sol = Typ 3

SCHUTZZAUNSYSTEM CLASSIC

PROTECTION FENCE SYSTEM CLASSIC

SYSTEME DE PROTECTION CLASSIC



Einhängfelder - EF

Suspensions fields (EF) · Modules suspendus (EF)

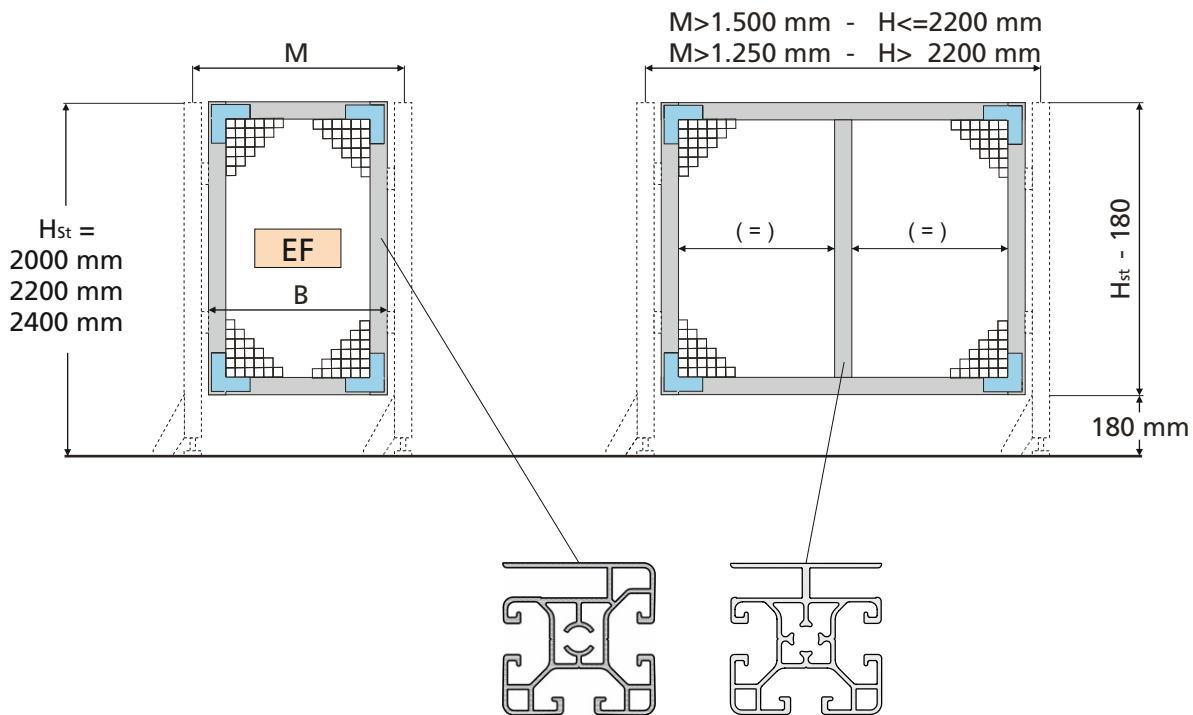

■ 11.05

EF ab Lager · Width from stock · Largeur pris en magasin

H _{Ges}	M (mm)	Art.Nr.
2.000 mm	750	05.05052.12
	1.000	05.05052.17
	1.250	05.05052.22
	1.500	05.05052.27
2.200 mm	750	05.05252.12
	1.000	05.05252.17
	1.250	05.05252.22
	1.500	05.05252.27
2.400 mm	750	05.05452.12
	1.000	05.05452.17
	1.250	05.05452.22
	1.500	05.05452.27

Rasterbreiten (50 mm) · Modular width · Largeur modular

H _{Ges}	M	Art.Nr.
2.000 mm	xy	05.05052.xy
2.200 mm	xy	05.05252.xy
2.400 mm	xy	05.05452.xy

$xy = M : 50 - 3$

Bsp: $M = 800 \text{ mm} \rightarrow xy = 800:50-3 = 11$

$300 \text{ mm} \leq M \leq 2000 \text{ mm}$

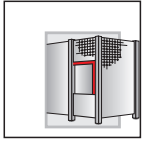

SCHUTZZAUNSYSTEM CLASSIC

PROTECTION FENCE SYSTEM CLASSIC

SYSTEME DE PROTECTION CLASSIC



Classic - Einhängung

Suspension element · Élément de suspension

Merkmale

- Durch spezielle Einhängung schneller Zugang zum geschützten Objekt
- Entspricht Maschinenrichtlinie 2006 / 42 / EG
- Einfacher und schneller Aufbau
- Ein-Mann-Montage
- Spaltmaß $S = 22,5$ (20) mm

Characteristics

- Special suspension for faster access to protected object
- Suitable to machinery directive 2006 / 42 / EG
- One man assembly
- Clearance $S = 22.5$ (20) mm

Caracteristique

- Module facilement démontable, accessibilité aisée
- Conforme à la directive machine 2006 / 42 / EG
- Juste 1 personne nécessaire pour le système d'accrochage
- Fente $S = 22.5$ (20) mm

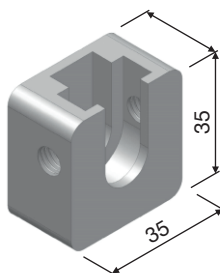
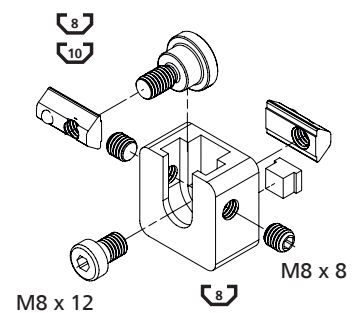
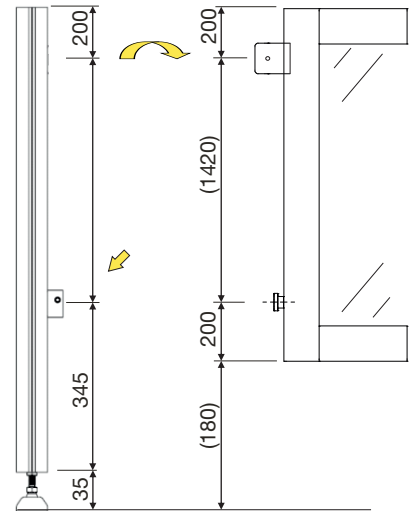
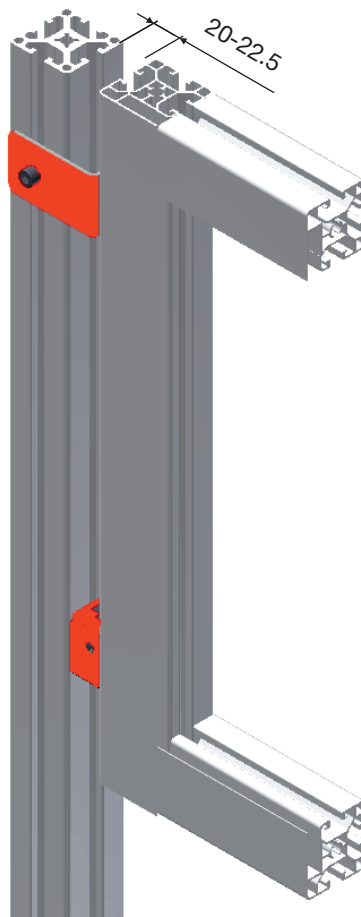
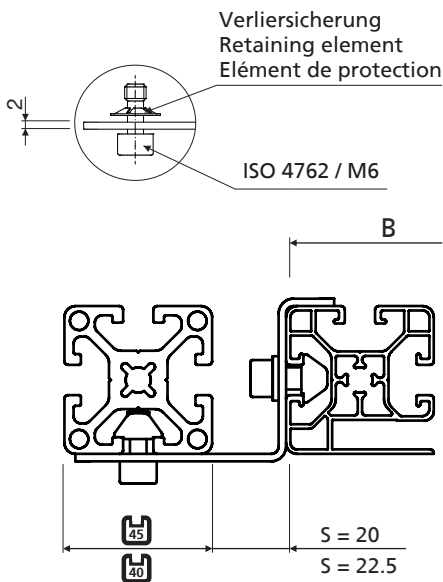

Technische Änderungen vorbehalten

		+	Anbausatz Adapter kit Kit de montage	05.02014.40
		+	Anbausatz Adapter kit Kit de montage	05.02052.05
		+	Anbausatz Adapter kit Kit de montage	05.02014.20
		+	Anbausatz Adapter kit Kit de montage	05.02052.20

SCHUTZZAUNSYSTEM CLASSIC

PROTECTION FENCE SYSTEM CLASSIC

SYSTEME DE PROTECTION CLASSIC



Winkeleinhängung

Angle suspension element · Élément de suspension articulé

Merkmale

- Stützen können bis zu 60°(55°) axial verdreht und somit in eine nicht rechteckige Anordnung gebracht werden
- Sehr stabile Einhängung
- Spaltmaß S = 22,5 mm

Characteristics

- Pillars can be axial contorted in an angle of 60°(55°)
- Very solide suspension
- Clearance S = 22.5 mm

Caracteristique

- Piliers peut braque axial à un angle de 60°(55°)
- Le système d'accrochage très stable
- Fente S = 22.5 mm

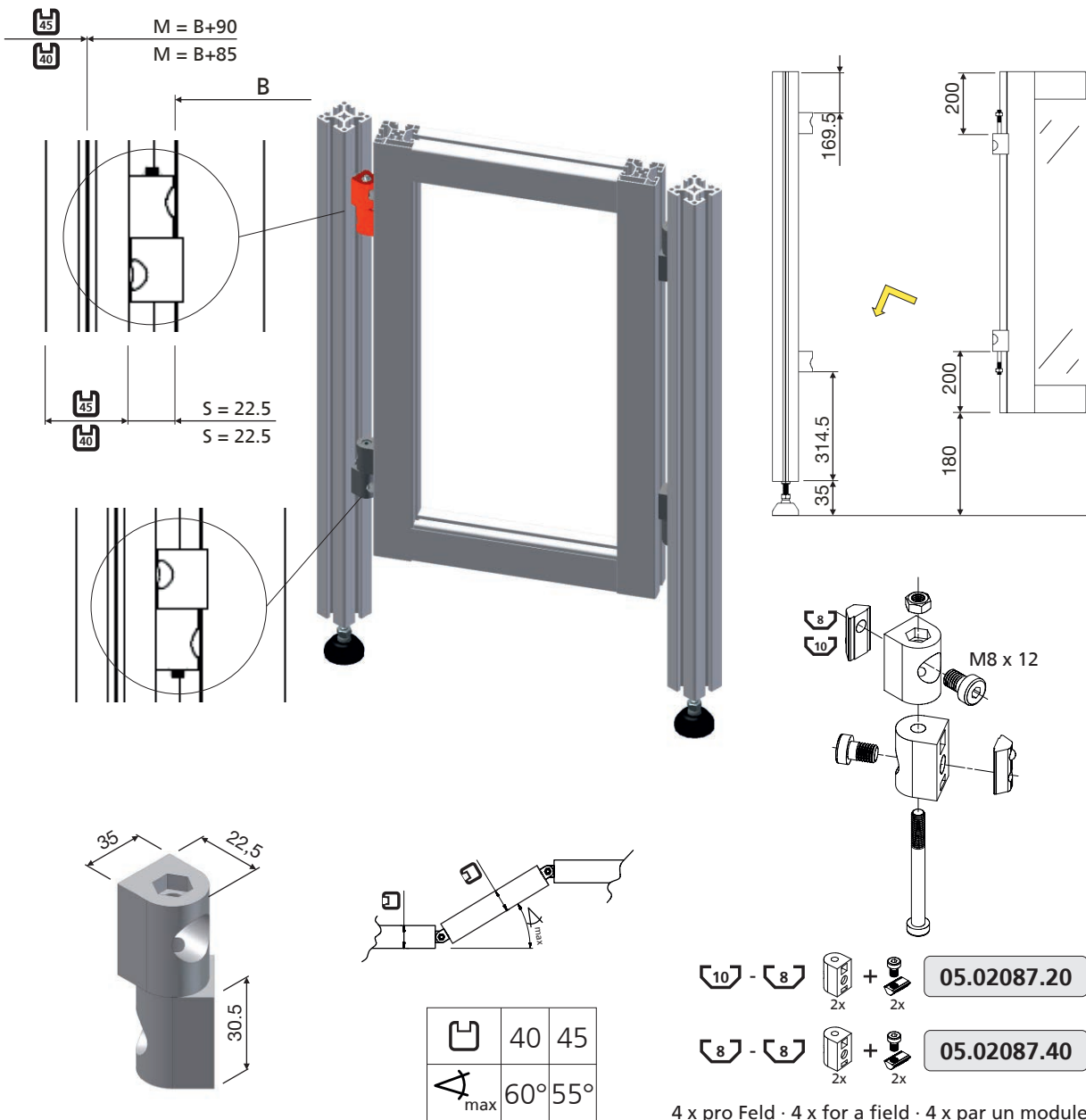

11

Technische Änderungen vorbehalten

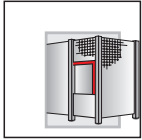

SCHUTZZAUNSYSTEM UNI

PROTECTION FENCE SYSTEM UNI

SYSTEME DE PROTECTION UNI



ECO Schutzzaunwinkel

ECO protective fence angle bracket · Equerre de suspension ECO

Merkmale:

- Einhängfelder (EF) und Stützen können unter variablem Winkel montiert werden
- Einhängfelder (EF) werden bei der Montage eingehängt und mit dem Winkel oben befestigt
- Spaltmaß S = 20 (17,5) mm

Characteristics

- Suspension fields (EF) and pillars can be mounted in different angle
- During assembly, suspension fields (EF) and columns are just hooked in and fastened with the FM screw
- Clearance S = 20 (17.5) mm

Caracteristique

- Modules suspendus (EF) et piliers peuvent être montés à un angle variable
- Montage simple par vis FM
- Fente S = 20 (17.5) mm

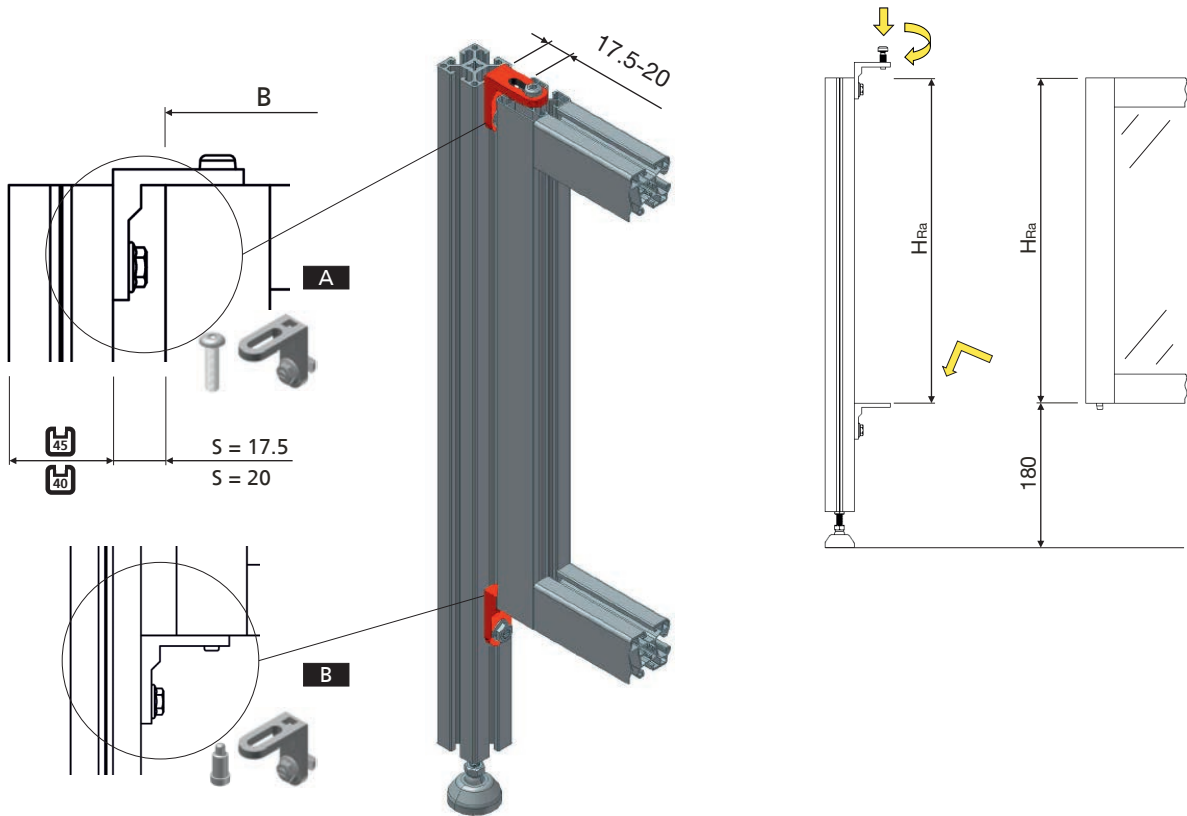

FM-Schraube
FM-Screw
Vis FM

Einhängebolzen
Suspension pin
Goujon d'accrochage

Zentrierstück
Centering piece
Morceau de centre

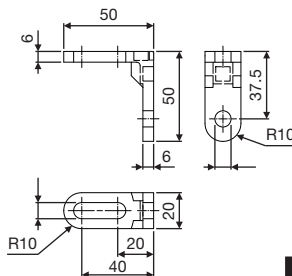

GD-Zn
05.02034.00

A 2x + 2x + 2x
05.02034.20

A 2x + 1x + 1x
05.02034.10

B 2x + 1x + 1x
05.02034.30

A 2 x pro Feld · 2 x for a field · 2 x par un module
B 2 x pro Feld · 2 x for a field · 2 x par un module

Technische Änderungen vorbehalten

EINHÄNGEBAUWEISE CLASSIC

SUSPENSION CONSTRUCTION CLASSIC

CONSTRUCTION D'ACCROCHAGE CLASSIC



ECO-Einhängung

ECO suspension element · Élément de suspension ECO

Merkmale

- Durch spezielle Einhängung, schneller Zugang zum geschützten Objekt
- Einfacher und schneller Aufbau
- Entspricht Maschinenrichtlinie 2006 / 42 / EG
- Ein-Mann-Montage
- Spaltmaß $S = 12-14$ mm

Characteristics

- Special suspension for faster access to protected object
- Fast and easy assembly
- Suitable to machinery directive 2006 / 42 / EG
- One man assembly
- Clearance $S = 12-14$ mm

Caractéristique

- Module facilement démontable, accessibilité aisée
- Le assemblage est rapide et simple
- Conforme à la directive machine 2006 / 42 / EG
- Juste une personne nécessaire pour le système d'accrochage
- Fente $S = 12-14$ mm

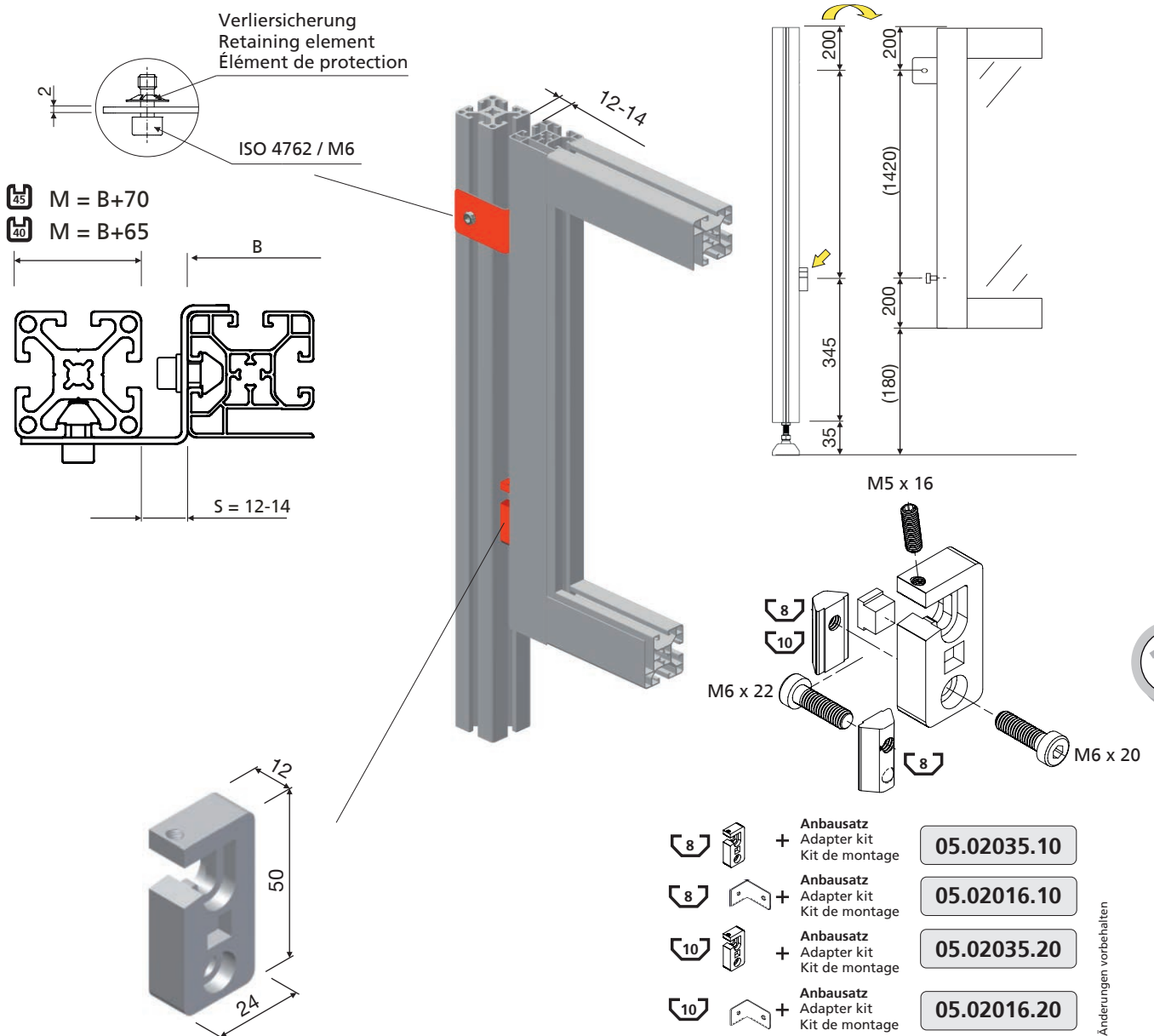

2 x pro Feld · 2 x for a field · 2 x par un module

Technische Änderungen vorbehalten

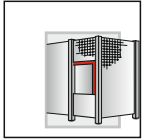

SCHUTZZAUNSYSTEM
PROTECTIVE FENCE SYSTEM
SYSTEME DE PROTECTION DE ZONE



Anwendungsbeispiele

Sample applications · Exemples d'application

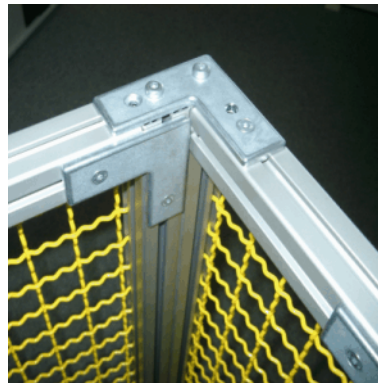

Für mehr Informationen
 bitte separaten Katalog
 anfordern!

Schutzzaunkatalog

Please request separate
 catalogue for more
 information!

Protective Fence catalogue

Pour plus d'informations,
 demandez notre catalogue
 détaillé !

**Système de protection de
 zone catalogue**

Technische Änderungen vorbehalten

SCHALLSCHUTZ SOUND INSULATION INSONORISATION



Laute Lärmquellen müssen mit geeigneten Schalldämmverkleidungen umbaut werden, um die Personenschutzvorschriften zu erfüllen.

FM SYSTEME bietet mit der modularen Dämmplatte in Verbindung mit dem Clips-Einfassprofil sowie dem Aluprofilsystem Baureihe 45 ein kostengünstiges Gesamtsystem.

Innovative Vorteile

- Erleichterte Planung durch Standardelemente
- Schneller und effizienter Aufbau der Schallschutzkabinen
- Schall-Absorption und Schalldämmung in einem Element
- Einbau von Schallschutz-Fenstern möglich
- Planung und Ausführung durch FM-Systeme möglich

Loud sources of noise must be surrounded with suitable sound insulation panels in order to fulfill staff protection regulations.

FM SYSTEME offers an economic overall system with the modular sound insulation panels in combination with the clip fastening system, as well as the 45 series aluminium profile system.

Innovative advantages

- Easy planning with standard elements
- Faster and more efficient erection of the sound insulation cabins
- Sound absorption and sound insulation in one element
- Installation of sound insulation windows possible
- Planning and installation by FM Systeme possible

Le respect des prescriptions sur la protection des personnes implique la mise en place d'isolations acoustiques adaptées en cas de nuisances sonores.

FM SYSTEME propose un système complet comprenant des panneaux isolants modulaires adaptés au profilé d'encadrement clipsé pour la série rainure 45.

Atouts novateur

- Conception facilitée par la mise en oeuvre d'éléments standard
- Réalisation rapide et efficace des cabines d'insonorisation
- Absorption acoustique et insonorisation optimisées
- Montage de isolation phonique possible
- Implantation et réalisation par FM Systeme

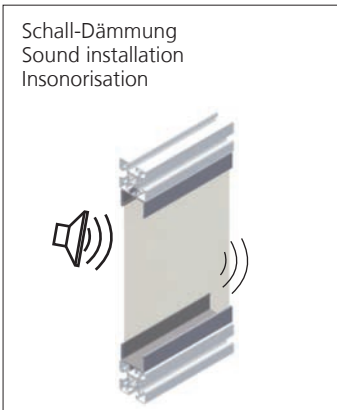

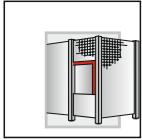

Clip-Einfassprofil

Clip fastening profile · Profilé d'encadrement

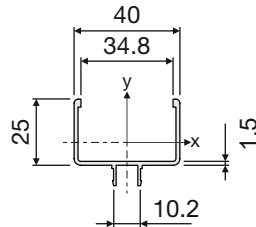
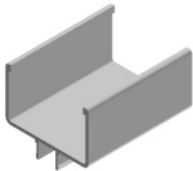

05.02250.00

M = 0.41 kg/m

Schalldämmplatte

Insulating panel · Panneau iso

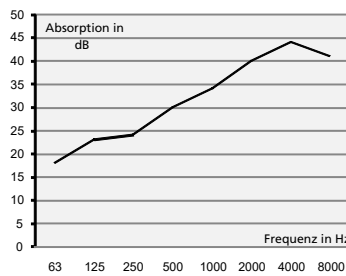
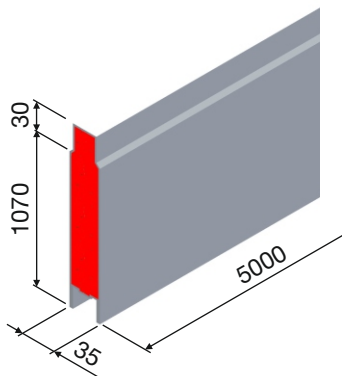

05.02251.00

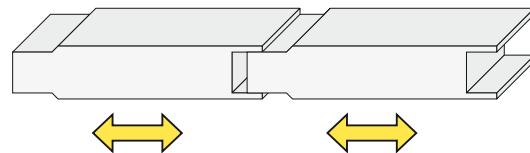

Querschnitt

Cross-section · Section

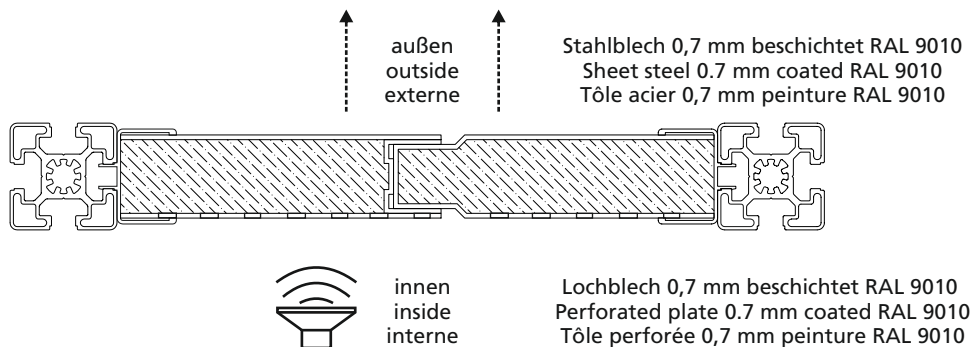

Technische Änderungen vorbehalten

RUNDPROFILSYSTEM Ø48

ROUND PROFILE SYSTEM Ø48

PROFILES ROUNDS Ø48



- Formschönes Design
- Im Außen- u. Innenbereich einsetzbar
- Aufnahme von verschiedenen Flächenelementen
- Als Handlauf und als Maschinenabtrennung
- Für Geländer an Treppen, Podesten, Balkone
- Elegant design
- Suitable for use in- and outdoor
- For securing a variety of panel elements
- As handrail and as machine separation
- For railings on stairways and ramps, balconies
- Bien design
- Application intérieure ou extérieure
- Panneaux de remplissage de tous types
- Main-courante d'escalier
- Garde-corps d'estrade et de balcon, séparateur d'espaces

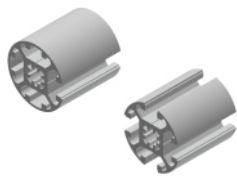

■ 11.18



■ 11.19

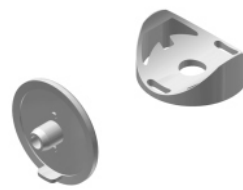

■ 11.20



■ 11.22



■ 11.21



■ 11.23

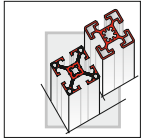

RUNDPROFILE Ø48
ROUND PROFILES Ø48
PROFILES RONDS Ø48



10

Ø48-3N

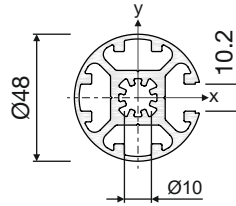
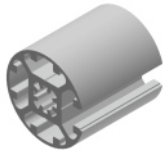

05.02090.00

M = 2.03 kg/m
 $I_x = 11.71 \text{ cm}^4$
 $W_x = 4.88 \text{ cm}^3$
 $I_y = 12.82 \text{ cm}^4$
 $W_y = 5.34 \text{ cm}^3$

PE (m)
 6 / 48 / 96 / 144

Ø48-2N90°

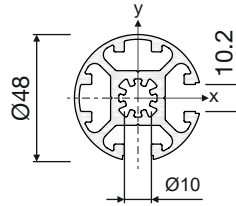
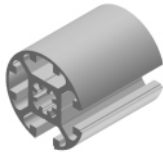

05.02091.00

M = 1.97 kg/m
 $I_x = 10.65 \text{ cm}^4$
 $W_x = 4.43 \text{ cm}^3$
 $I_y = 12.79 \text{ cm}^4$
 $W_y = 5.32 \text{ cm}^3$

PE (m)
 3

Ø48-2N180°

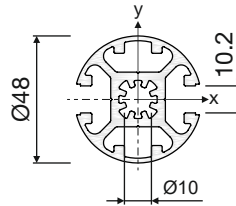

05.02092.00

M = 1.97 kg/m
 $I_x = 10.65 \text{ cm}^4$
 $W_x = 4.43 \text{ cm}^3$
 $I_y = 12.79 \text{ cm}^4$
 $W_y = 5.32 \text{ cm}^3$

PE (m)
 6 / 48 / 96 / 144

Ø48-1N

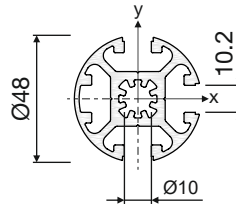
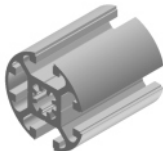

05.02093.00

M = 1.92 kg/m
 $I_x = 11.66 \text{ cm}^4$
 $W_x = 4.85 \text{ cm}^3$
 $I_y = 10.62 \text{ cm}^4$
 $W_y = 4.42 \text{ cm}^3$

PE (m)
 3

Ø48

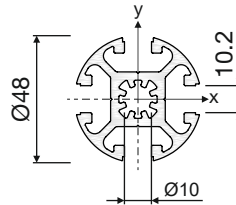
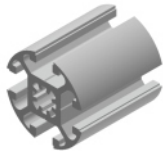

05.02088.00

M = 1.86 kg/m
 $I_x = 11.60 \text{ cm}^4$
 $W_x = 4.42 \text{ cm}^3$
 $I_y = 11.60 \text{ cm}^4$
 $W_y = 4.42 \text{ cm}^3$

PE (m)
 3

Ø48-4N

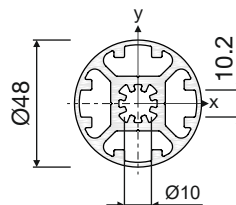
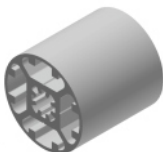

05.02089.00

M = 2.09 kg/m
 $I_x = 12.83 \text{ cm}^4$
 $W_x = 5.35 \text{ cm}^3$
 $I_y = 12.83 \text{ cm}^4$
 $W_y = 5.35 \text{ cm}^3$

PE (m)
 3

Technische Änderungen vorbehalten

VERBINDUNGSELEMENTE
CONNECTING ELEMENTS
ELEMENTS DE JONCTION

AGV

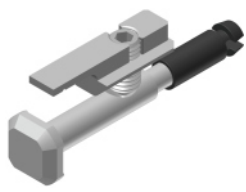

➔ ■ 3.04

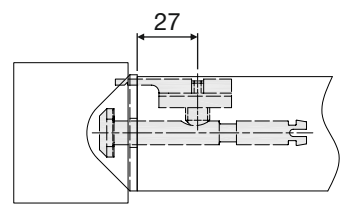

05.01782.00

GV



➔ ■ 3.02

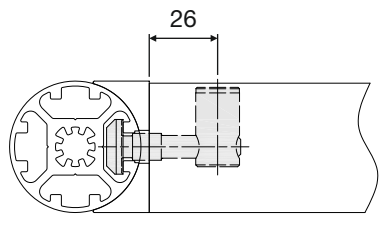

05.01352.00

SF 12x40

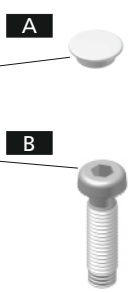
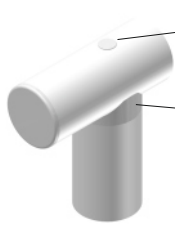

➔ ■ 3.17

PA 6
 lichtgrau
 light grey
 gris clair

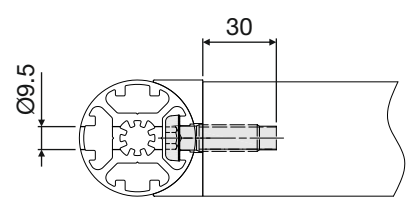

A 05.01023.00

B 05.01127.00

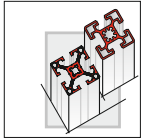

ZUBEHÖR
ACCESSORIES
ACCESSOIRES



Radienausgleich Ø48

Radius compensation Ø48 · Compensateur de rayon Ø48

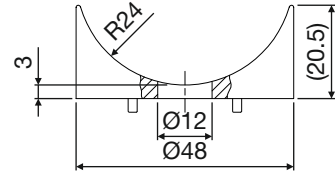
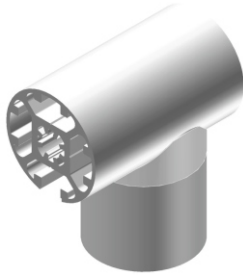

PA 6
lichtgrau
light grey
gris clair

05.02094.00

Radienausgleich 45x45

Radius compensation 45x45 · Compensateur de rayon 45x45

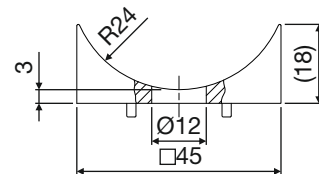
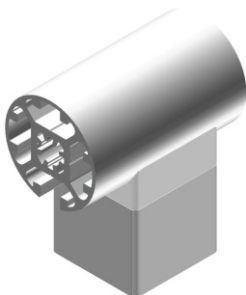

PA 6
lichtgrau
light grey
gris clair

05.02095.00

Abdeckkappe Ø48

Covering cap Ø48 · Cache Ø48

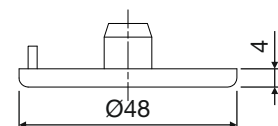
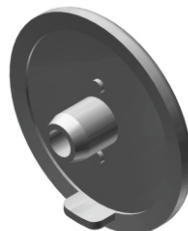

PA 6
lichtgrau
light grey
gris clair

05.02097.00

BODENBLECHE
BASE PANELS
PLAQUES

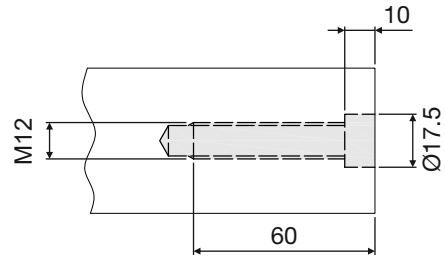
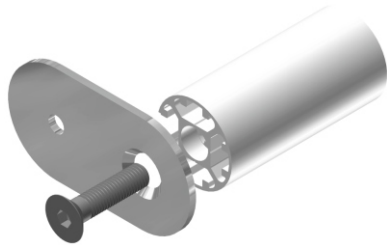

VA
 elektropoliert
 electropolished
 électro-astiquer



05.01172.00

62x117

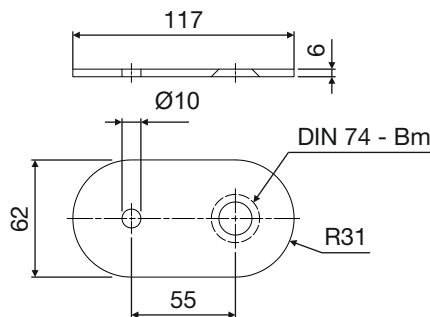

05.02280.00

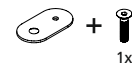

05.02280.05

62x172

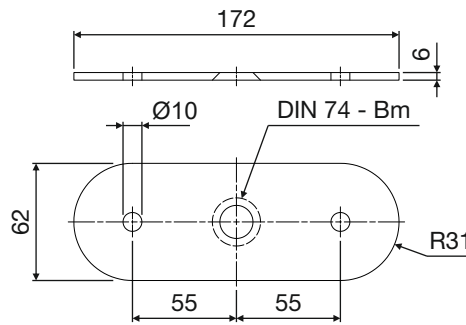

05.02281.00

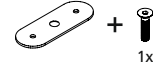

05.02281.05

90° - 62x75x75

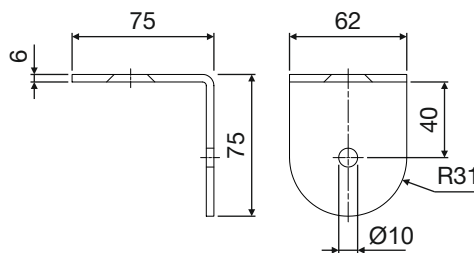

05.02282.00

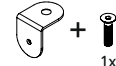

05.02282.05

Technische Änderungen vorbehalten

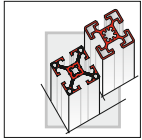

BODENBEFESTIGUNG
BASE FASTENING
ANCORAGE AU SOL



Wandbefestigung Ø100

Pipe base clamp · Embase d'ancrage

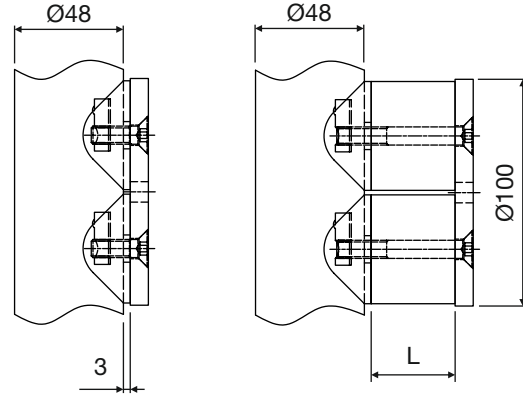

VA
 elektropoliert
 electropolished
 électro-astiquer

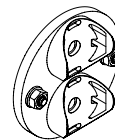

05.02346.00

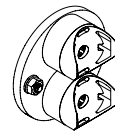

L= mm 05.02372.00

Bodenwinkel 30x120 - 10

Base bracket 30x120 - 10 · Equerre d'ancrage 30x120 - 10

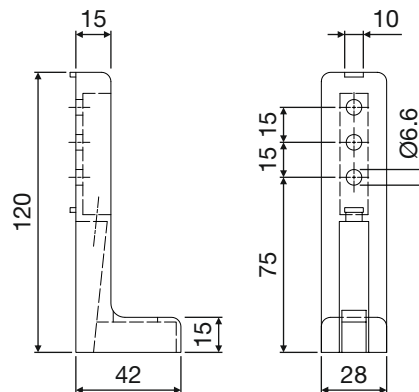
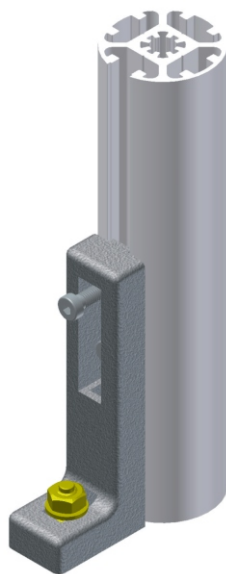

GD-Zn
 Blank
 Bare
 Brut

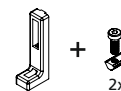

+ 2x 05.02199.05



1x 05.01172.00

→ ■ 5.10

Technische Änderungen vorbehalten

Glashalter

Glass holder · Porte-verre

GD-Zn
poliert
polished
peint

	05.02198.00
+ 1x	05.02198.05

Dichtprofil

Sealing profile · Joint de profil

→ ■ 7.04

5	05.02070.00
2 mm	05.02071.00
4 mm	05.02072.00
5 mm	05.02073.00
6 mm	05.02075.00

Abdeck- und Einfassprofil

Covering and fastening profile · Clapet de couvercle et profil à border

→ ■ 7.03

schwarz	black	noir	9011	05.01187.00
---------	-------	------	------	--------------------

Technische Änderungen vorbehalten

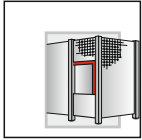

SCHUTZZAUNSYSTEM RIEGEL

PROTECTIVE FENCE SYSTEM INTERLOCK

FERMETURE DE PROTECTION DE ZONE PAR VERROU



Merkmale

- Geeignet für Euchner Sicherheits-schalter der Serie TZ und NZ
- Für rechts und links anschlagende Türen und Fenster
- Anbau an Nut 8 und Nut 10
- Für Schwenk- und Schiebetüren geeignet

Characteristics

- Suitable for Euchner safety switches of the TZ and NZ series
- For right and left closing doors
- Mounting on groove 8 and groove 10
- Suitable for swivel and sliding doors

Caractéristiques

- Compatible avec contacteurs de sécurité Euchner TZ, NZ et similaires
- Pour portes battantes et coulissantes gauche et droite
- Pour rainures 8 et 10
- Pour la porte battante et coulissante convenable

Anwendung

Application · Application

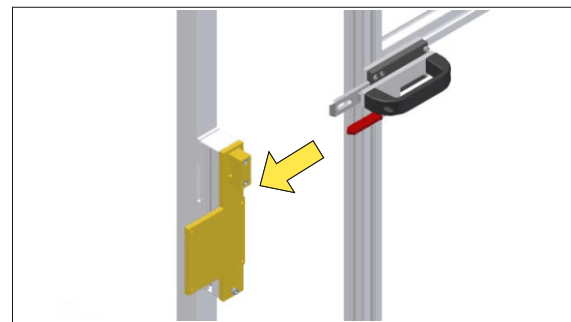
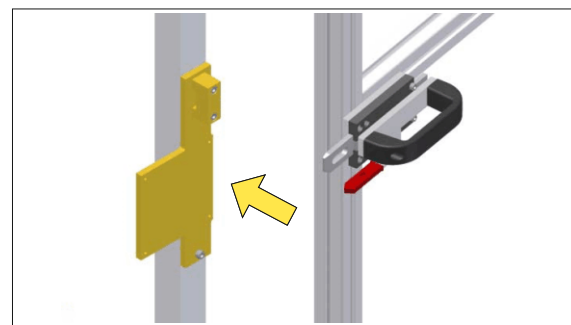
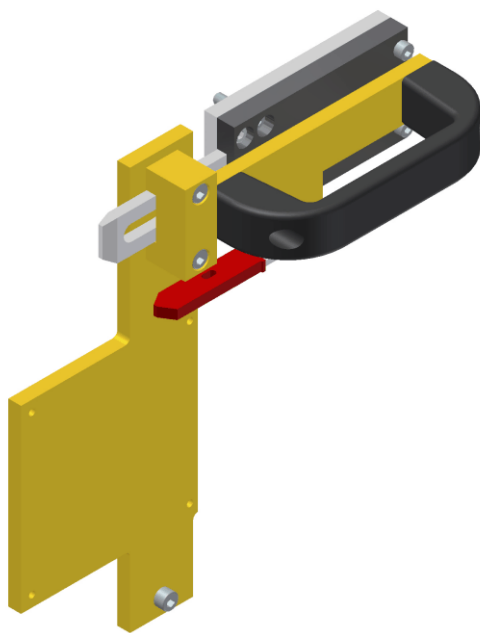

Ausführung

Model · Type

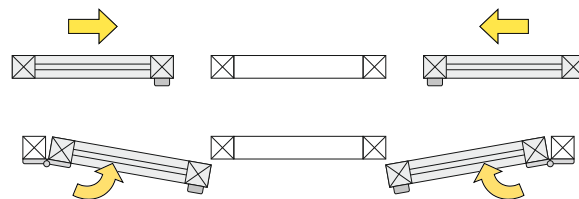
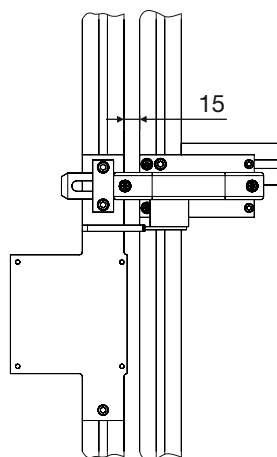

Anschlag links
Closing left
Version gauche

05.02039.10

Anschlag rechts
Closing right
Version droite

05.02039.00

Technische Änderungen vorbehalten

LINEARFÜHRUNGEN
LINEAR GUIDING SYSTEM
GUIDAGE LINEAIRE SYSTEM



■ 12.04

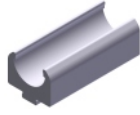

■ 12.04



■ 12.05

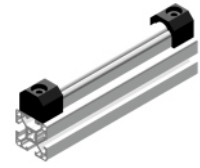

■ 12.05

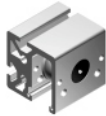

■ 12.05



■ 12.05



■ 12.06



■ 12.06



■ 12.06



■ 12.08



■ 12.08



■ 12.08



■ 12.09

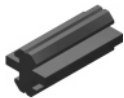

■ 12.09

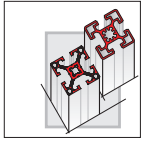

LINEARFÜHRUNGSSYSTEM LINEAR GUIDING SYSTEM GUIDAGE LINEAIRE SYSTEM



Innovative Vorteile

- System zum Aufbau von Führungsschlitten und Lineareinheiten für spielfrei laufende Systeme in Verbindung mit Welle Ø14
- Ein geschliffener Führungsradius erlaubt eine hohe Kraftübertragung zur Welle

Innovative advantages

- Systeme for the installation of linear guiding systems in connection with axle Ø14
- A grounded radius allows a high power transmission to the axle

Atouts novateur

- Systeme pour la guidage lineaire avec connexion pivot Ø14
- Un radius rectifié permetre une transmission d'énergie forte

Anwendungen

Applications · Applications

Zul. empfohlene Lasten:

F1 = 1500 N
F2 = 3000 N
F3 = 1500 N

Laufleistung bei max. Last:

10.000 km

Max. Geschwindigkeit:

10 m/sek

Rated loads:

F1 = 1500 N
F2 = 3000 N
F3 = 1500 N

Service life at max. load:

10.000 km

Max. speed:

10 m/sec

Charges utiles :

F1 = 1500 N
F2 = 3000 N
F3 = 1500 N

Intervale de service :

10.000 km

Vitesse maximale :

10 m/sec

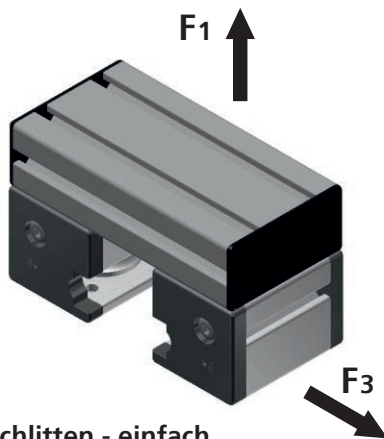

Führungsschlitten - einfach
Guide block - single
Rail à galts simple

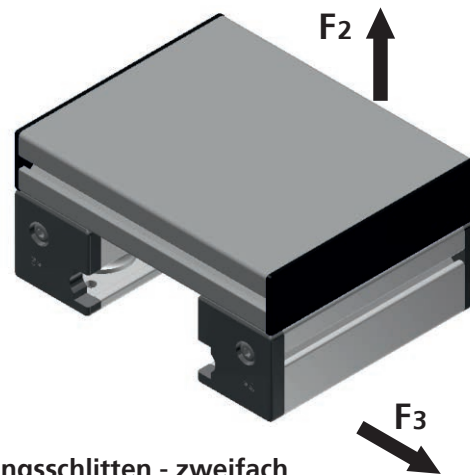

Führungsschlitten - zweifach
Guide block - dual
Rail à galts double

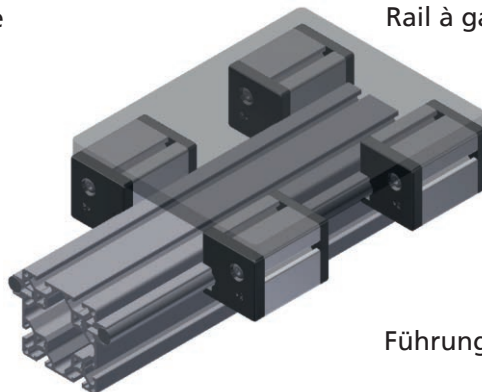

Führungsschlitten - individuell

LINEARFÜHRUNGSSYSTEM

LINEAR GUIDING SYSTEM

GUIDAGE LINEAIRE SYSTEM

- Grundkonstruktionen aus Profilen der Profilreihe 40 / Nut 8 mit Rollenführung auf Welle Ø14
- Basic constructions made of profiles 40 / profile groove 8 with roller guidance on shaft Ø14
- Constructions de base a partir de profilé 40 / rainure de profilé 8 avec rouleau de conseil sur l'arbre Ø14

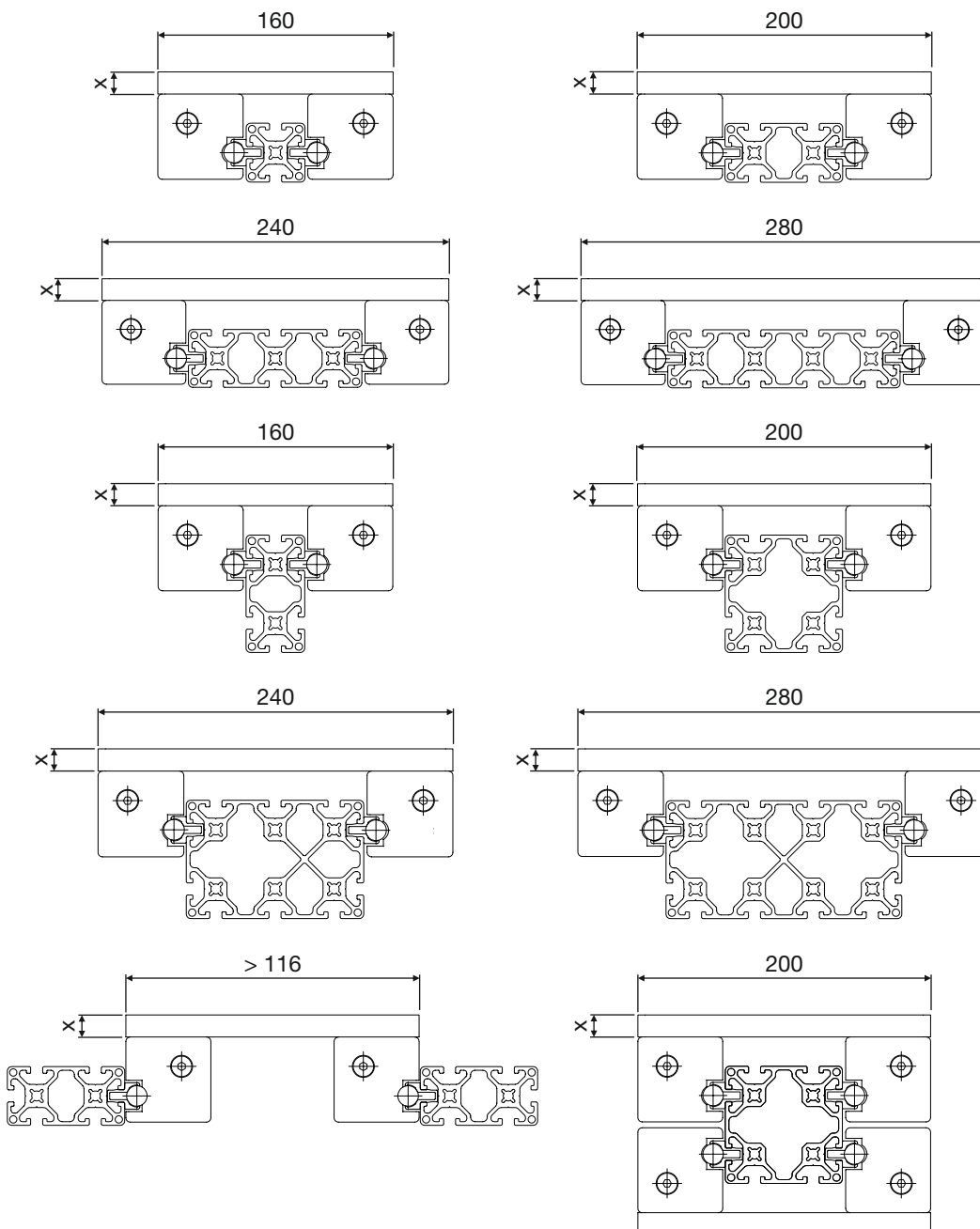
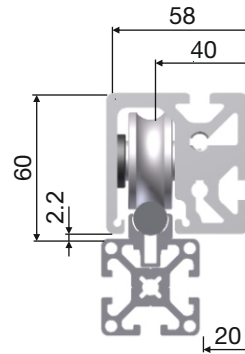

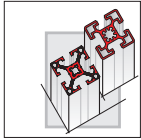

LINEARFÜHRUNGSSYSTEM LINEAR GUIDING SYSTEM GUIDAGE LINEAIRE SYSTEM



Wellenklemmprofil

Shaft clamp profile · Profile support arbre



05.01030.00

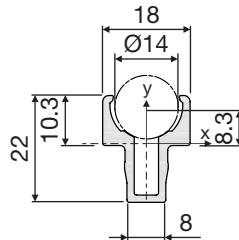
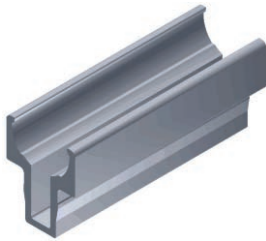

M = 0.31 kg/m
I_x = 0.39 cm⁴
W_x = 0.35 cm³
I_y = 0.38 cm⁴
W_y = 0.34 cm³

PE (m)
3 / 6

Ø 16



05.02130.00

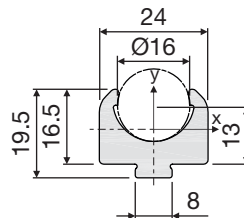
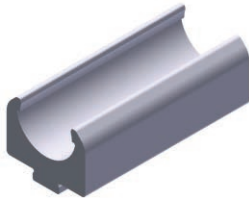

M = 2.20 kg/m
I_x = 12.50 cm⁴
W_x = 5.63 cm³
I_y = 19.36 cm⁴
W_y = 6.53 cm³

PE (m)
6 / 48 / 96

Ø 20



05.02131.00

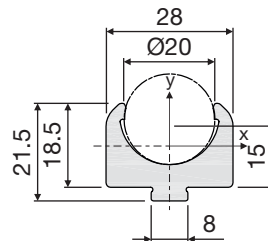
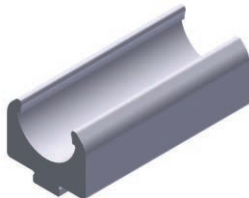

M = 2.78 kg/m
I_x = 16.45 cm⁴
W_x = 6.76 cm³
I_y = 41.28 cm⁴
W_y = 10.62 cm³

PE (m)
6 / 48 / 96

Bohrbild Ø16 / Ø20

Drilling diagram Ø16 / Ø20 · Schéma de perçage Ø16 / Ø20

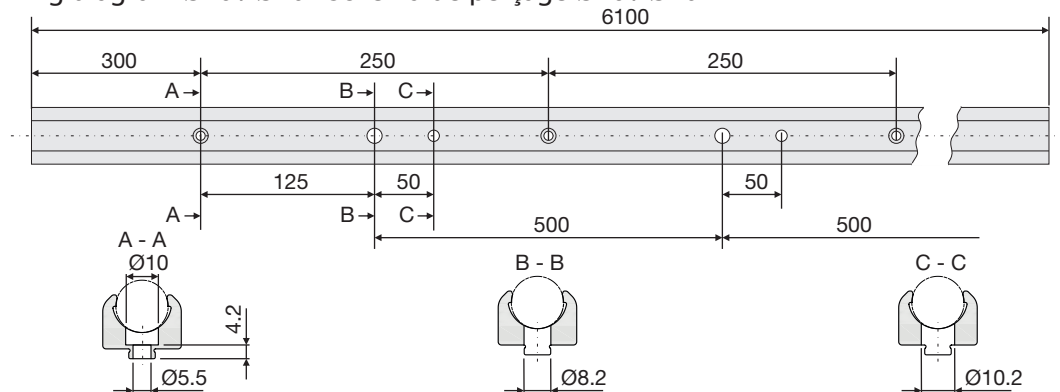

Technische Änderungen vorbehalten

LINEARFÜHRUNGSSYSTEM

LINEAR GUIDING SYSTEM

GUIDAGE LINEAIRE SYSTEM



8

Welle Ø14, Ø16, Ø20

Shaft Ø14, Ø16, Ø20 · Arbre Ø14, Ø16, Ø20

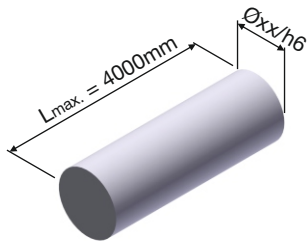

Welle

- CF53, gehärtet, geschliffen
- Härte 59+6 HRC
- Rauheit Ra = 0,35µm

Shaft

- CF53, hardened, ground
- Hardness 59+6 HRC
- Roughness Ra=0.35µm

Arbre

- CF53, trempé, rectifié
- Dureté 59+6 HRC
- Rugosité Ra=0,35µm

Ø14 **05.01031.00**

Ø16 **05.02134.00**

Ø20 **05.02135.00**

Wellenendstück

Axial stop · Butée axiale

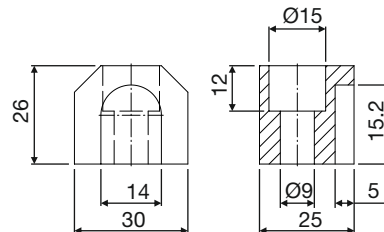
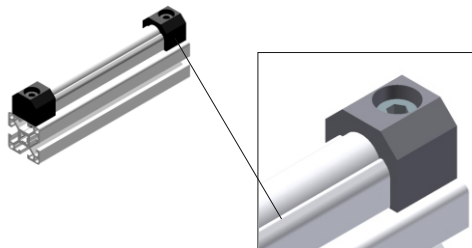

05.02136.05

Lagereinheit 8 Ø14 - einfach

Bearing unit 8 Ø14 - single · Unité de roulement 8 Ø14 - simple

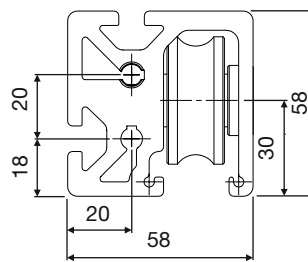
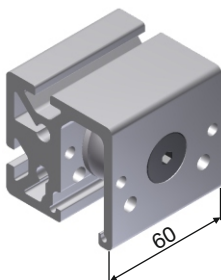

zentrisch **05.02403.00**

exzentrisch **05.02404.00**

Lagereinheit 8 Ø14 - zweifach

Bearing unit 8 Ø14 - double · Unité de roulement 8 Ø14 - double

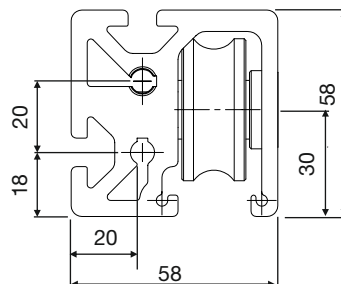
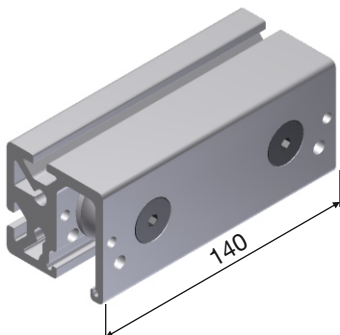

zentrisch **05.02405.00**

exzentrisch **05.02406.00**

12

Technische Änderungen vorbehalten

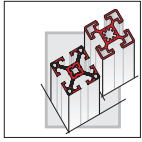

LINEARFÜHRUNGSSYSTEM LINEAR GUIDING SYSTEM GUIDAGE LINEAIRE SYSTEM



Laufrolle Ø14

Roller Ø14 · Rouleau Ø14

05.02408.00

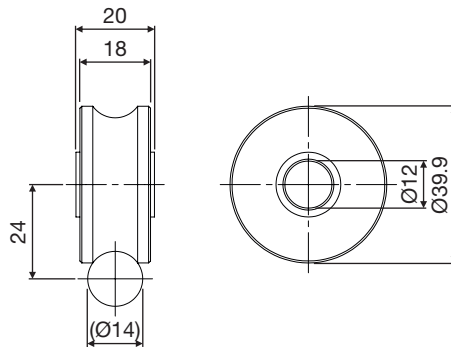
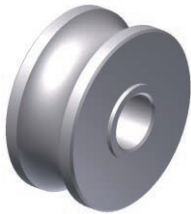

Lagerbolzen 8 Ø14 - zentrisch

Bolt 8 Ø14 - central · Boulon 8 Ø14 - central

05.02409.00

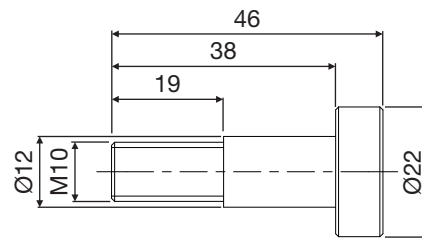

- Stahl, schwarz
- Steel, black
- Acier, noire

Lagerbolzen 8 Ø14 - exzentrisch

Bolt 8 Ø14 - excentric · Boulon 8 Ø14 - excentrique

05.02410.00

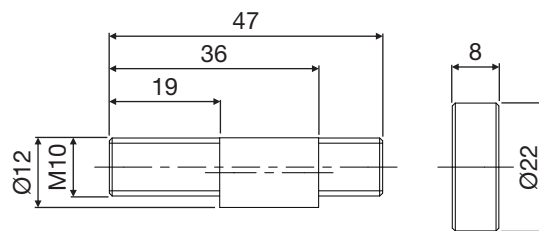

- Stahl, schwarz
- Zur nachträglichen, spielfreien Einstellung der Lagereinheit
- Steel, black
- For additional adjustment of the bearing unit
- Acier, noire
- Pour après ajustement de la unité de roulement

Abstreif- und Schmiereinheit 8 Ø14

Oiling unit · Unité de lubrification

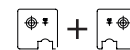

05.02407.00

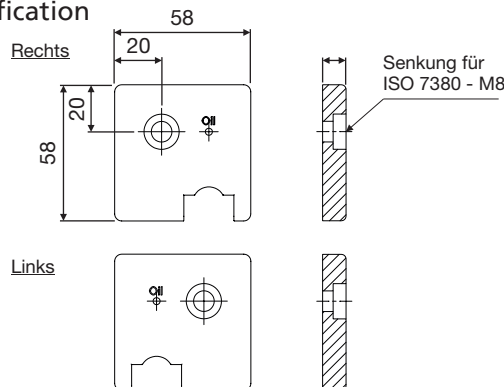

- PA-GF, schwarz
- Schutz und Schmierung der Lagereinheit
- PA-GF, black
- Protection and lubrication of the bearing Unit
- PA-GF, noire
- Protection et lubrification de l'unité de roulement

SCHLITTENSYSTEM SLIDING SYSTEM UN SYSTEME DE TRANSLATION



Innovative Vorteile

- Verschieben und bewegen
- Verändern und einstellen
- Justieren und positionieren
- Manuell oder angetrieben
- Robust und hoch belastbar
- Platzsparend und formschön
- Flexibel und preisgünstig

Innovative advantages

- Pushed and moved
- Changed and adjusted
- Position and aligned
- By hand or motor-driven
- Rugged and extremely hard-wearing
- Space-saving and attractive design
- Economical and flexible

Atouts novateur

- Déplacer et bouger
- Modifier et adapter
- Ajuster et positionner
- Manuellement ou automatique
- Robuste et à haute capacité de charge
- Peu encombrant, élégant
- Flexible et d'un prix avantageux

Anwendungen

Applications · Applications

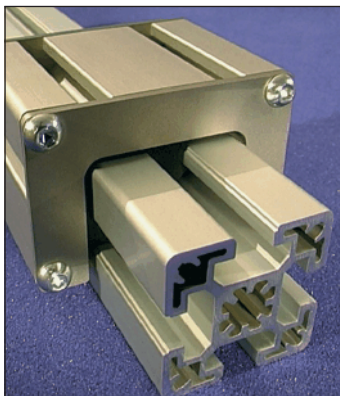
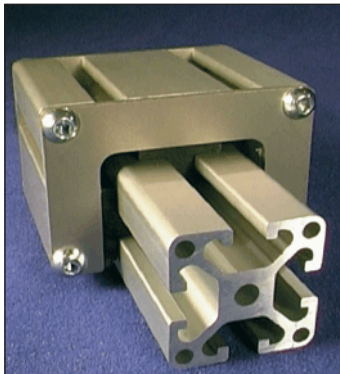
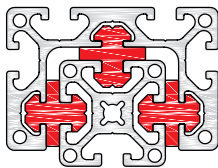
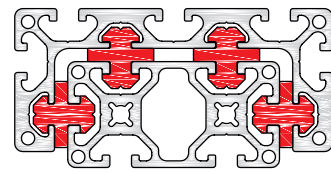
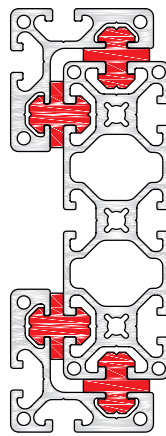
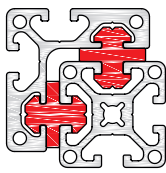

12

Technische Änderungen vorbehalten

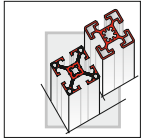

SCHLITTENPROFILE
SLIDE PROFILES
PROFILE DE TRANSLATION



Eckschlitten 40

Corner slides 40 · Élément de coin L 40

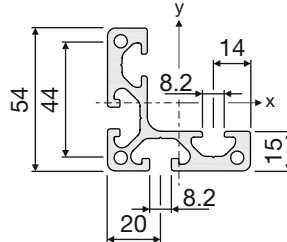
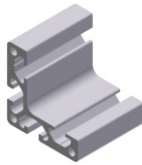

05.01714.00

M = 1.91 kg/m
 $I_x = 24.35 \text{ cm}^4$
 $W_x = 9.02 \text{ cm}^3$
 $I_y = 24.35 \text{ cm}^4$
 $W_y = 9.02 \text{ cm}^3$

PE (m)
 6 / 24 / 48 / 72

U-Schlitten 40/80

U-slides 40/80 · Élément U 40/80

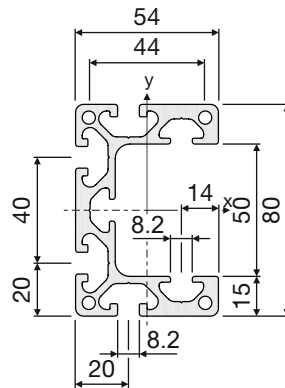
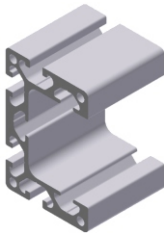

05.01715.00

M = 3.14 kg/m
 $I_x = 97.75 \text{ cm}^4$
 $W_x = 24.44 \text{ cm}^3$
 $I_y = 37.58 \text{ cm}^4$
 $W_y = 13.92 \text{ cm}^3$

PE (m)
 6 / 18 / 36 / 54

U-Schlitten 80/120

U-slides 80/120 · Élément U 80/120

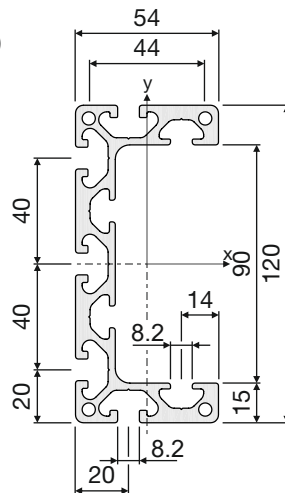
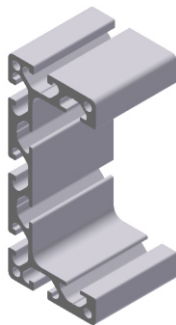

05.01716.00

M = 3.91 kg/m
 $I_x = 272.30 \text{ cm}^4$
 $W_x = 45.38 \text{ cm}^3$
 $I_y = 49.81 \text{ cm}^4$
 $W_y = 18,45 \text{ cm}^3$

PE (m)
 6 / 18 / 36 / 54

Technische Änderungen vorbehalten

Abdeckkappen

Cover caps · Embouts



05.01890.10



05.01891.10



05.01892.10

Gleitprofile

Slide profiles · Patins



Die an den seitlichen Gleitflächen angebrachten Lippen, gleichen die Toleranzen ($\pm 0,2$ mm) der Aluprofile aus und ermöglichen somit ein gleichmäßiges Verschieben.

The lips located on the side sliding surfaces compensate the tolerances ($\pm 0,2$ mm) of the aluminium profiles and allow smooth sliding.

Les lèvres placées sur les surfaces de glissement latérales compensent les tolérances ($\pm 0,2$ mm) des profilés alu et permettent ainsi un glissement uniforme.

PE-HD
schwarz
antistatisch

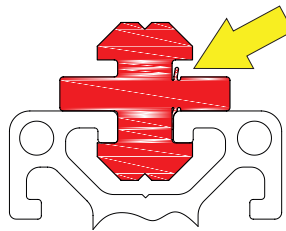

→ ■ 12.08

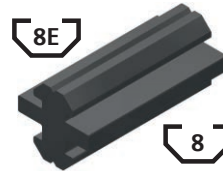

05.01896.00
PE=2000 mm

05.01896.01

L=49 mm

05.01896.02

L=99 mm

05.01896.03

L=199 mm

05.01896.04

L=299 mm

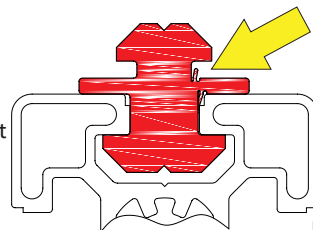

→ ■ 12.07

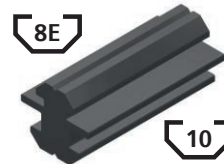

05.01897.00
PE=2000 mm

05.01897.01

L=49 mm

05.01897.02

L=99 mm

05.01897.03

L=199 mm

05.01897.04

L=299 mm

Fixierung für Gleitprofil

Fastener for slide profile · Butée pour patins

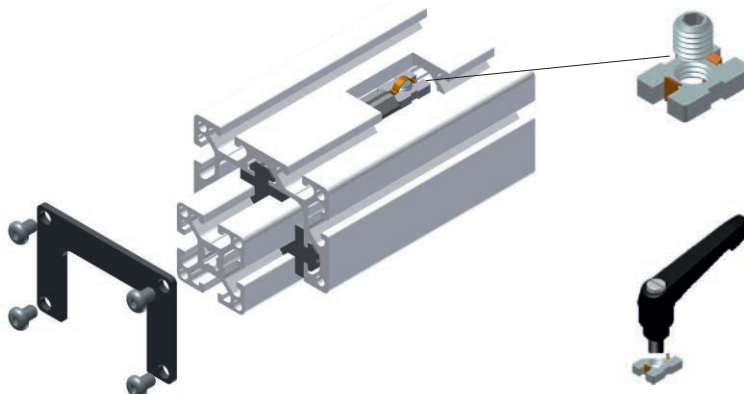

05.01895.00

05.01895.05

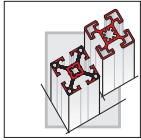

GLEITPROFILE 8E

SLIDE PROFILE 8E

PATINS 8E



8E / 8E

beidseitiger Kopf

Double-sided head · Tête bilatérale axiale

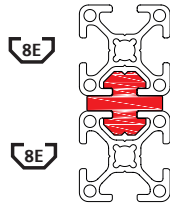
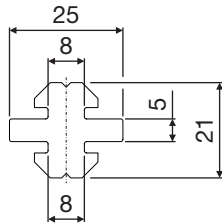

PE-HD
schwarz
antistatisch

PE= 2.000 mm

05.01880.00

8E / 10

beidseitiger Kopf, für Profil 45

Double-sided head, for profile 45 ·
Tête bilatérale axiale, pour profilé 45

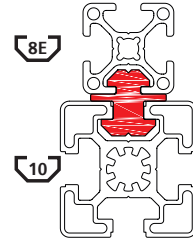
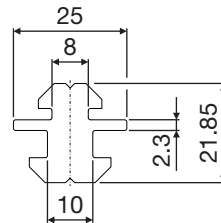

PE-HD
schwarz
antistatisch

PE= 2.000 mm

05.01897.00

8E / 8E

einseitiger Kopf, mittiger Steg

Single-sided head, central fin ·
Tête unilatérale, axiale

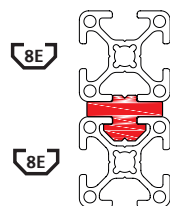
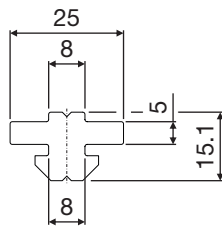

PE-HD
schwarz
antistatisch

PE= 2.000 mm

05.01881.00

8E

einseitiger Kopf, Plan 5 mm

Single-sided head, flush 5 mm ·
Tête unilatérale plate 5 mm

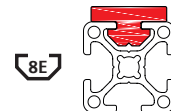
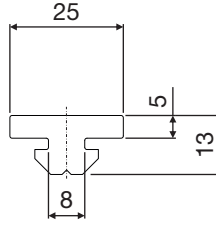

PE-HD
schwarz
antistatisch

PE= 2.000 mm

05.01898.00

8E / 8E

einseitiger Kopf, exzentrischer Steg

Single-sided head, excentric fin ·
Tête unilatérale, désaxée

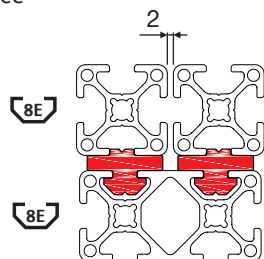
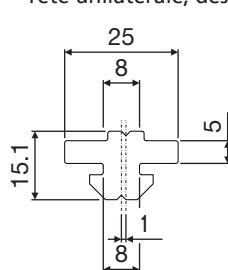

PE-HD
schwarz
antistatisch

PE= 2.000 mm

05.01882.00

Technische Änderungen vorbehalten

GLEITPROFILE 8

SLIDE PROFILE 8

PATINS 8

8 / 8 beidseitiger Kopf
 Double-sided head · Tête bilatérale axiale

PE-HD
 schwarz
 antistatisch

PE= 2000 mm
05.01341.00

8 / 8E beidseitiger Kopf, für Profil 30
 Double-sided head, for profile 30 ·
 Tête bilatérale axiale, pour profilé 30

PE-HD
 schwarz
 antistatisch

PE= 2000 mm
05.01896.00

8 / 8 einseitiger Kopf, mittiger Steg
 Single-sided head, central fin ·
 Tête unilatérale, axiale

PE-HD
 schwarz
 antistatisch

PE= 2000 mm
05.01884.00

8 einseitiger Kopf, plan 10 mm
 Single-sided head, flush 10 mm ·
 Tête unilatérale, plate 10 mm

PE-HD
 schwarz
 antistatisch

PE= 2000 mm
05.01335.00

8 / 8 einseitiger Kopf, exzentrischer Steg
 Single-sided head, excentric fin ·
 Tête unilatérale, désaxée

PE-HD
 schwarz
 antistatisch

PE= 2000 mm
05.01879.00

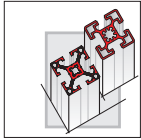

GLEITPROFILE 10

SLIDE PROFILE 10

PATINS 10



10 / 10 beidseitiger Kopf
Double-sided head · Tête bilatérale axiale

PE-HD
schwarz
antistatisch

PE= 2000 mm
05.01336.00

10 / 8 beidseitiger Kopf
Double-sided head · Tête bilatérale axiale

PE-HD
schwarz
antistatisch

PE= 2000 mm
05.01337.00

10 / 10 einseitiger Kopf, mittiger Steg
Single-sided head, central fin · Tête unilatérale, axiale

PE-HD
schwarz
antistatisch

PE= 2000 mm
05.01899.00

10 / 8 einseitiger Kopf, mittiger Steg
Single-sided head, central fin · Tête unilatérale, axiale

PE-HD
schwarz
antistatisch

PE= 2000 mm
05.01338.00

10 / 10 einseitiger Kopf, exzentrischer Steg
Single-sided head, excentric fin · Tête unilatérale, désaxée

PE-HD
schwarz
antistatisch

PE= 2000 mm
05.01339.00

10 einseitiger Kopf, Plan 10mm
Single-sided head, flush 10 mm · Tête unilatérale, plate 10 mm

PE-HD
schwarz
antistatisch

PE= 2000 mm
05.01340.00

Technische Änderungen vorbehalten

FÖRDERSTRECKENELEMENTE
CONVEYOR ELEMENTS
ELEMENTS DE CONVOYEUR

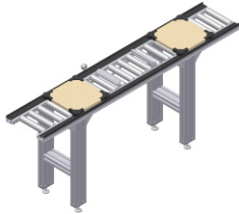

■ 13.02



■ 13.04

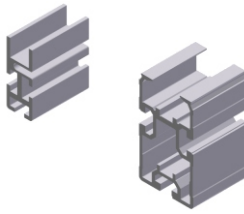

■ 13.10



■ 13.13

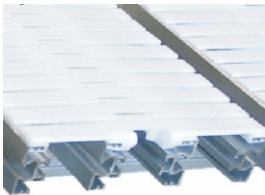

■ 13.15



■ 13.19

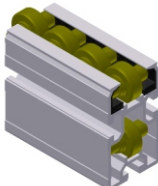

■ 13.20

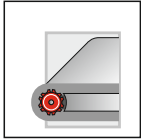

ECO-ROLL
ECO-ROLL
ECO-ROLL



- Werkstückträger-Transport und -Verkettungen von Handarbeitsplätzen
- Ab WT = 400mm auch mit angetriebenen Rollen erhältlich
- Anlagenausführungen mit Kurven, Eckstationen und Ausschleusungen auf Anfrage

- Workpiece carrier (WPC) transporter and interlinking of manual workplaces
- Also available with driven rollers as of WPC = 400mm
- System design with bends, corners stations and ejection points on request

- Déplacement manuel de palettes
- A partir de palettes = 400mm, également disponible avec rouleaux entraînés
- Sur demande, versions avec courbes, stations d'angle et sas de sortie

Anwendung

Application · Application

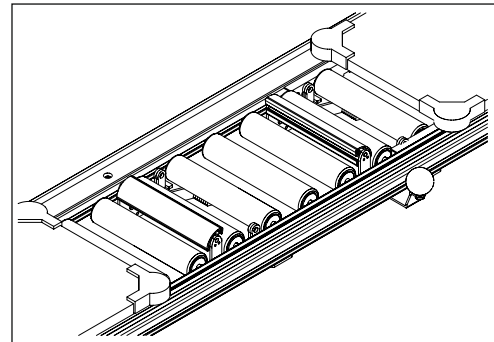
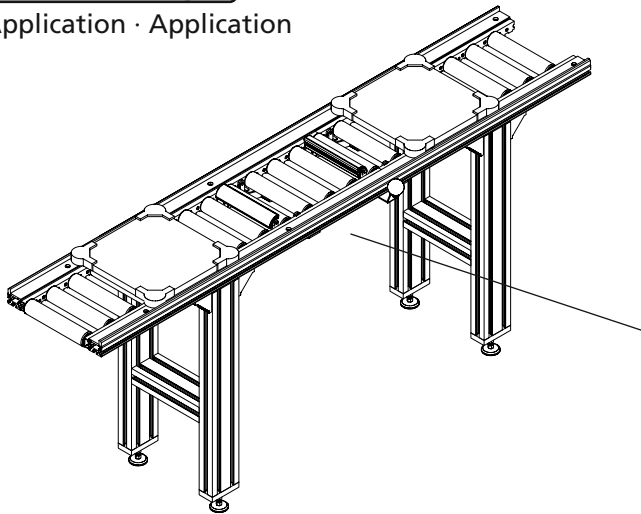

Querschnitt

Cross section · Section

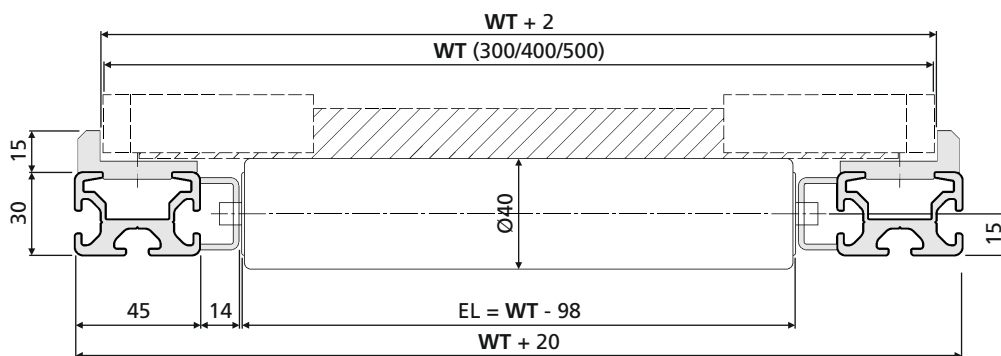

Streckenprofil SPR

Section profile SPR · Profilé de convoyage

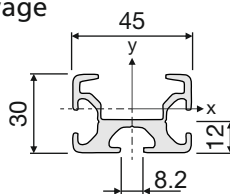
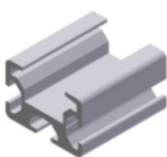

05.01021.00

M = 1.36 kg/m
 $I_x = 4.55 \text{ cm}^4$
 $W_x = 2.02 \text{ cm}^3$
 $I_y = 10.97 \text{ cm}^4$
 $W_y = 7.32 \text{ cm}^3$

PE (m)
 6 / 24 / 48 / 72

Werkstückträger - WT

Workpiece carriers · Palettes

Holzplatte mit Kunststoffecken
 Wooden pallet with plastic corners
 Palettes bois avec renfort angulaire
 plastique

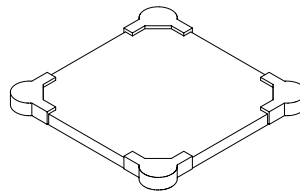

WT	
300 x 300	03.00510.00
300 x 400	03.00511.00
400 x 400	03.00512.00
400 x 500	03.00513.00
500 x 500	03.00514.00

Rollenhalter

Roller holder · Support rouleaux

$$n = \frac{L}{200}$$

n = Anzahl der Anbausätze
 Number of attachment kits
 Quantité de kits

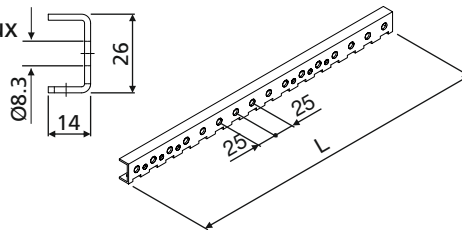

L	
600	03.00517.06
800	03.00517.08
1000	03.00517.00

Rollen

Rollers · Rouleaux

Einfache Montage und Demontage
 durch Federachse
 Spring axle for easy fitting and removal
 Montage et démontage aisés par axe à
 ressort

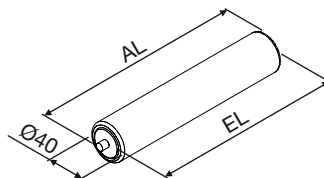

Rollen in der Ausführung Stahl und
 Kunststoff auf Anfrage erhältlich

Steel and plastic rollers available on
 request

Rouleaux disponibles en version acier et
 matière plastique sur demande

Stopper

Stopper · Butée

Manuelle Betätigung notwendig
 Manual activation necessary
 Actionnement manuel

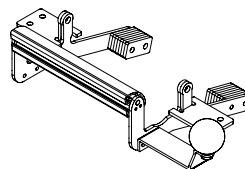

WT	
300	03.00540.30
400	03.00540.40
500	03.00540.50

Rücklaufsperr

Reverse lock · Blocage anti-retour

Automatisch durch Gegengewicht
 Automatic through counterweight
 Automatique par contre-poids

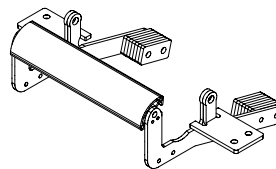

WT	
300	03.00541.30
400	03.00541.40
500	03.00541.50

Stützen

Supports · Piètement

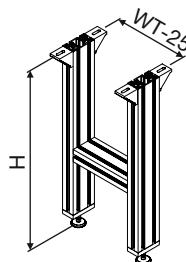

Stützenvariante aus Aluprofil 45x90L,
 Abmaße nach Kundenwunsch

Support variation made of aluminium
 profile 45x90L, dimensions to customer
 specifications

Variante de piètement en profilé alu
 45x90L dimensions sur mesure

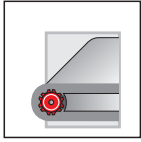

FM-ROLLENBAHN

FM ROLLER CONVEYOR

CONVOYEUR A ROULEAUX FM



FM Rollenbahn

FM Roller Conveyor · Convoyeur a rouleaux FM

- Schwerkraft-Rollenbahn für Teile- und Behältertransport
- Ab B = 400mm auch mit angetriebenen Rollen erhältlich
- Gravity roller conveyor for parts and container transport
- Also available with driven rollers as of B = 400mm
- Convoyeur à rouleaux gravitaire
- A partir d'une largeur = 400mm, également disponible avec rouleaux entraînés

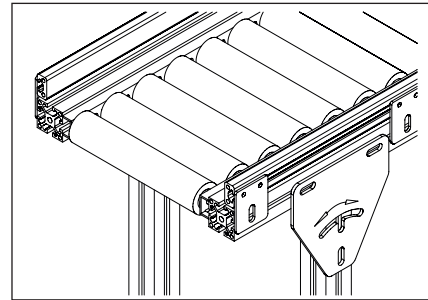
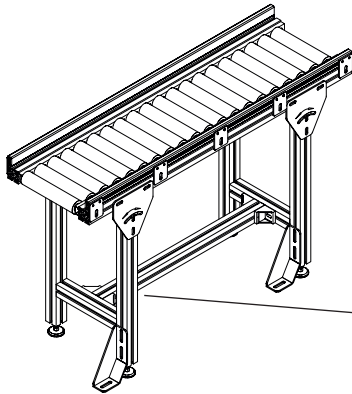

Querschnitt

Cross section · Section

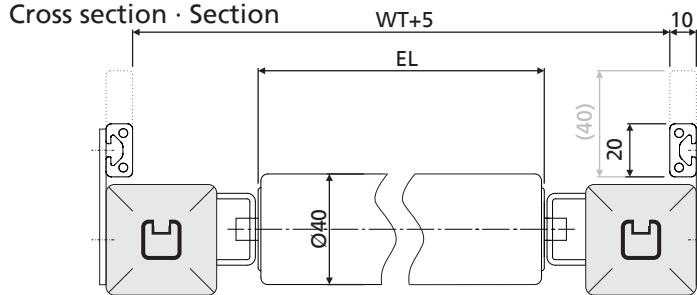

40 x 40 N → ■ 2.29



45 x 45 L → ■ 2.55

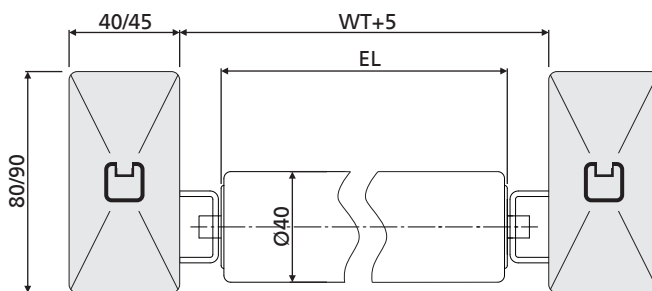

40 x 80 N → ■ 2.29



45 x 90 L → ■ 2.55

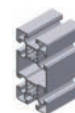

Rollen

Rollers · Rouleaux

Einfache Montage und Demontage durch Federachse

Spring axle for easy fitting and removal

Montage et démontage aisés par axe à Ressort

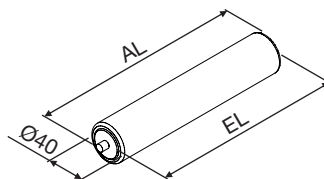

Rollen in der Ausführung Stahl und Kunststoff auf Anfrage erhältlich

Steel and plastic rollers available on request

Rouleaux disponibles en version acier et matière plastique sur demande

FM-ROLLENBAHN

FM ROLLER CONVEYOR

CONVOYEUR A ROULEAUX FM



FM-Rollenbahn mit FM-Schwerkraftrolle

FM roller conveyor · FM convoyeur à rouleaux

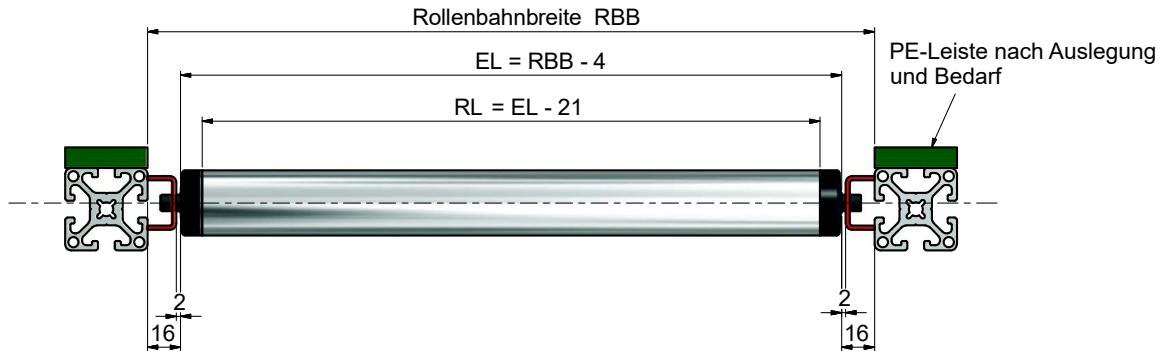

Rollenlager mit Federachse

Carrier roller · rouleaux porteurs

08.00663.00

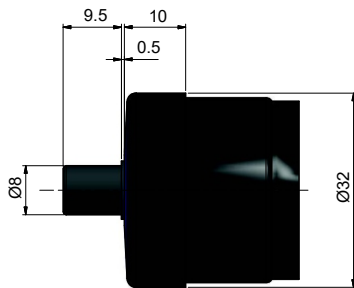

Tragrolle komplett

Complete carrier roller · Rouleaux porteurs complètement

08.00664.xx

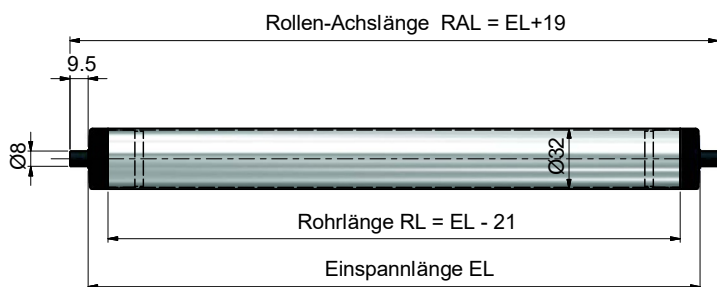

NICO-Rohr

NICO pipe · Tube NICO

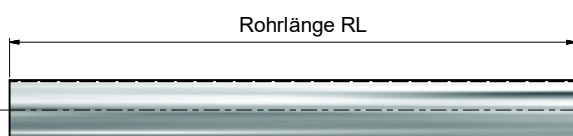

NICO-Rohr
Edelstahlrohr Ø 32 mm
NICO pipe
Steel pipe Ø 32 mm
Tube NICO
Tube acier Ø 32 mm

Technische Änderungen vorbehalten

13

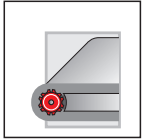

FM-ROLLENBAHN

FM ROLLER CONVEYOR

CONVOYEUR A ROULEAUX FM



Rollenhalter

Roller holder · Support rouleaux

$$n = \frac{L}{200}$$

n = Anzahl der Anbausätze
Number of attachment kits
Quantité de kits

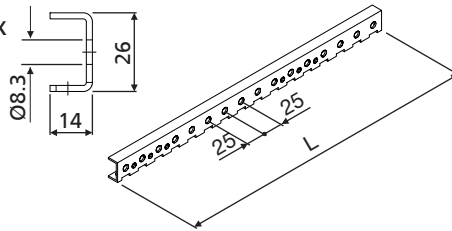

L	Part Number
600	03.00517.06
800	03.00517.08
1000	03.00517.00

Rollenaufnahme

Roller locator · Taquet support rouleau

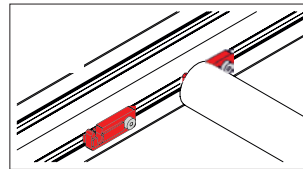
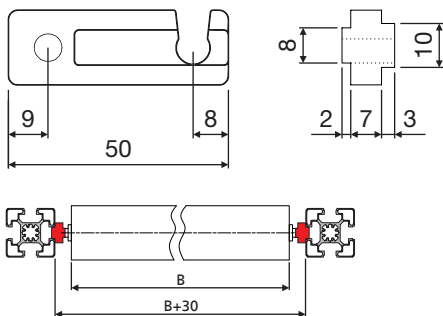

	05.01754.30
	05.01754.40
	05.01754.50

Seitenführung

Lateral guide · Glissières laterales

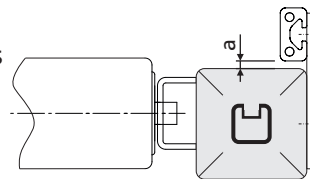
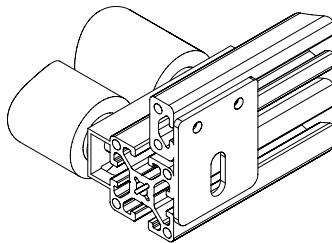

Spaltmaß a max. 10 mm
Gap size a max. 10 mm
Ecartement a max. 10 mm

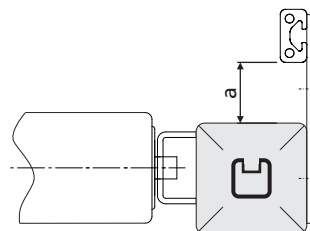

Spaltmaß a von 17 bis 32 mm
Gap size a from 17 to 32 mm
Ecartement a de 17 à 32 mm

Stützen

Supports · Piètement

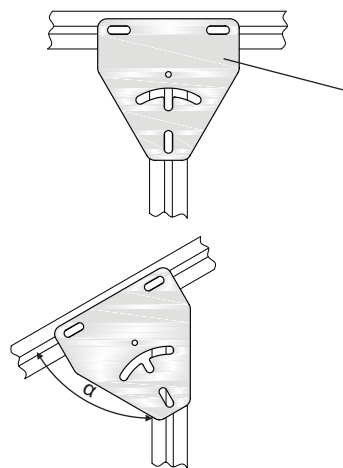
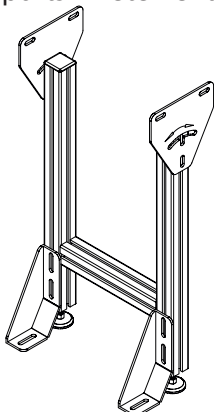

Halblech inkl. Befestigungssatz
Retaining plate with adapter kit
Interface piètement avec kit de montage

03.00880.05

Bandneigung von α 90° bis α 60°.
Neigungsverstellung von max. 30°

Belt inclination from 90° to 60°,
Max. inclination adjustment of 30°

Inclinaison de 90° à 60°
Réglage max. 30°

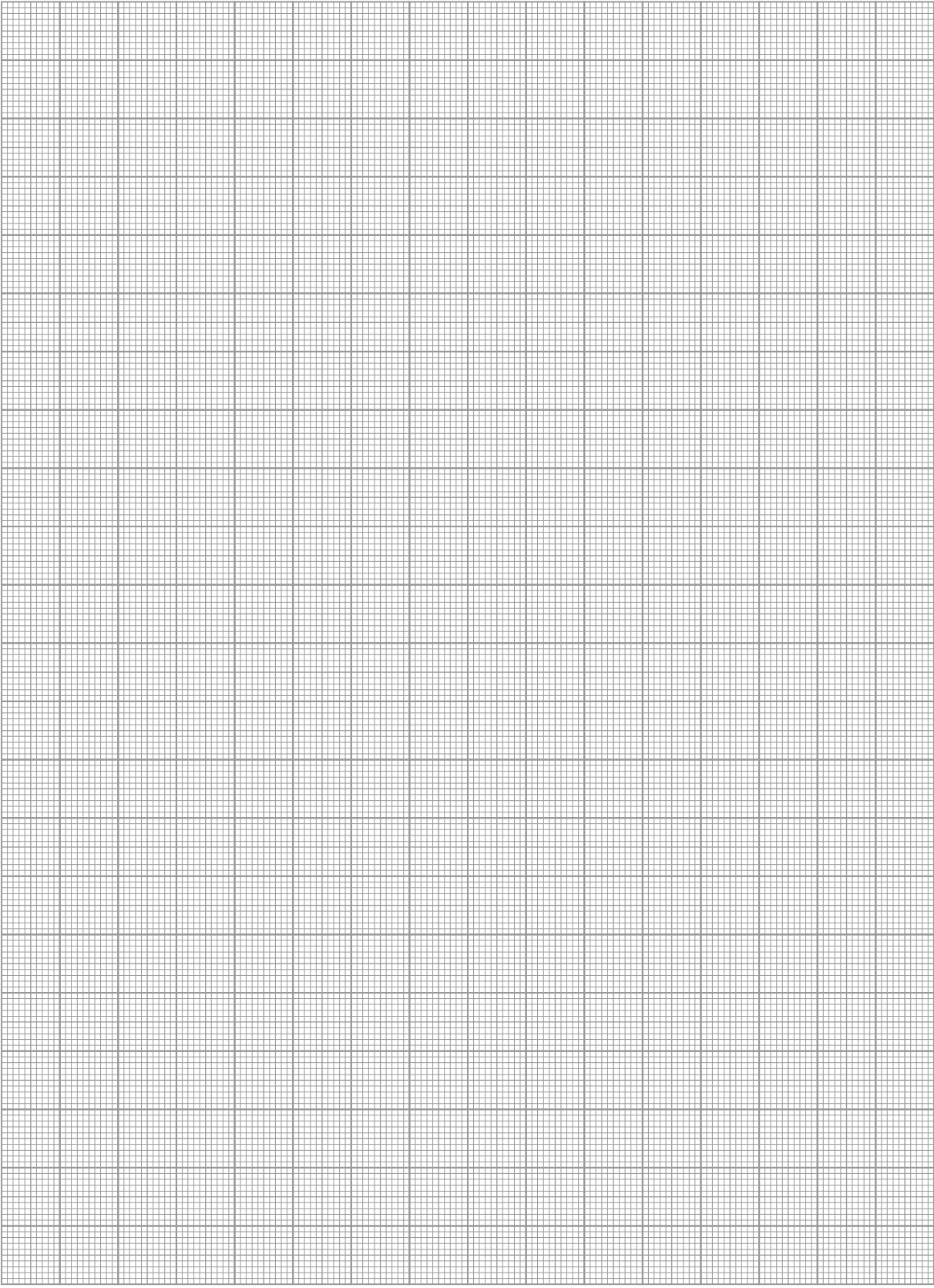

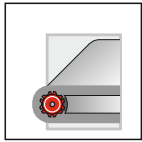

ECO-ROLLENSCHIENEN

ECO ROLLER RAILS

RAILS A GALET ECO



Profilschienen - Alu-Ausführung

Alu-Profile rails · Alu-Profilé rail

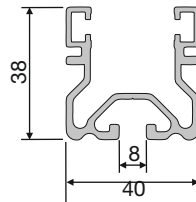

08.00299.00

PE (m)
6

Achsaufnahme

Axis absorption · Axe accueil

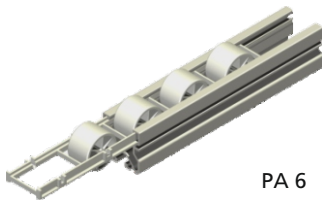

PA 6

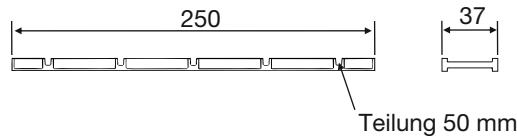

08.00313.00

Vorteil: Individuell mit farbigen Rollen bestückbar, sehr leiser Betriebslauf!

Rollen

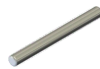

Achse
Axis
Axe

08.00298.00

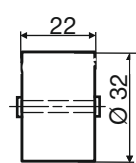
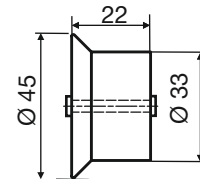
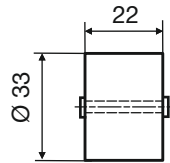

Weiß	White	Blanc	08.00293.00	08.00294.00	-----
ESD	ESD	ESD	08.00293.10	08.00294.10	-----
Rot	Red	Rouge	08.00293.20	08.00294.20	-----
Gelb	Yellow	Jaune	08.00293.30	08.00294.30	-----
Grün	Green	Verte	08.00293.40	08.00294.40	-----
Nico	Nico	Nico	-----	-----	08.00292.00

Profilschienen - Stahlausführung*

Profile rails · Profilé rail

Stahl, verzinkt
Steel, galvanized
Acier, zingué

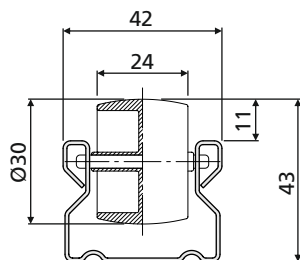

Typ 40 - A 08.00090.00

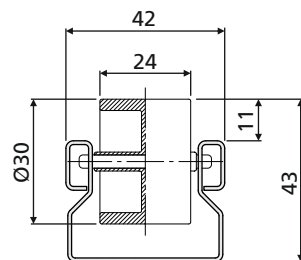

Typ 40 - B 08.00091.00
Typ 40 - B / ESD 08.00093.00

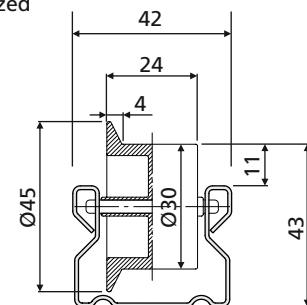

Typ 40 - B mit Bord 08.00092.00

Technische Änderungen vorbehalten

* Weitere Ausführungen siehe ECO-Rohr Katalog!

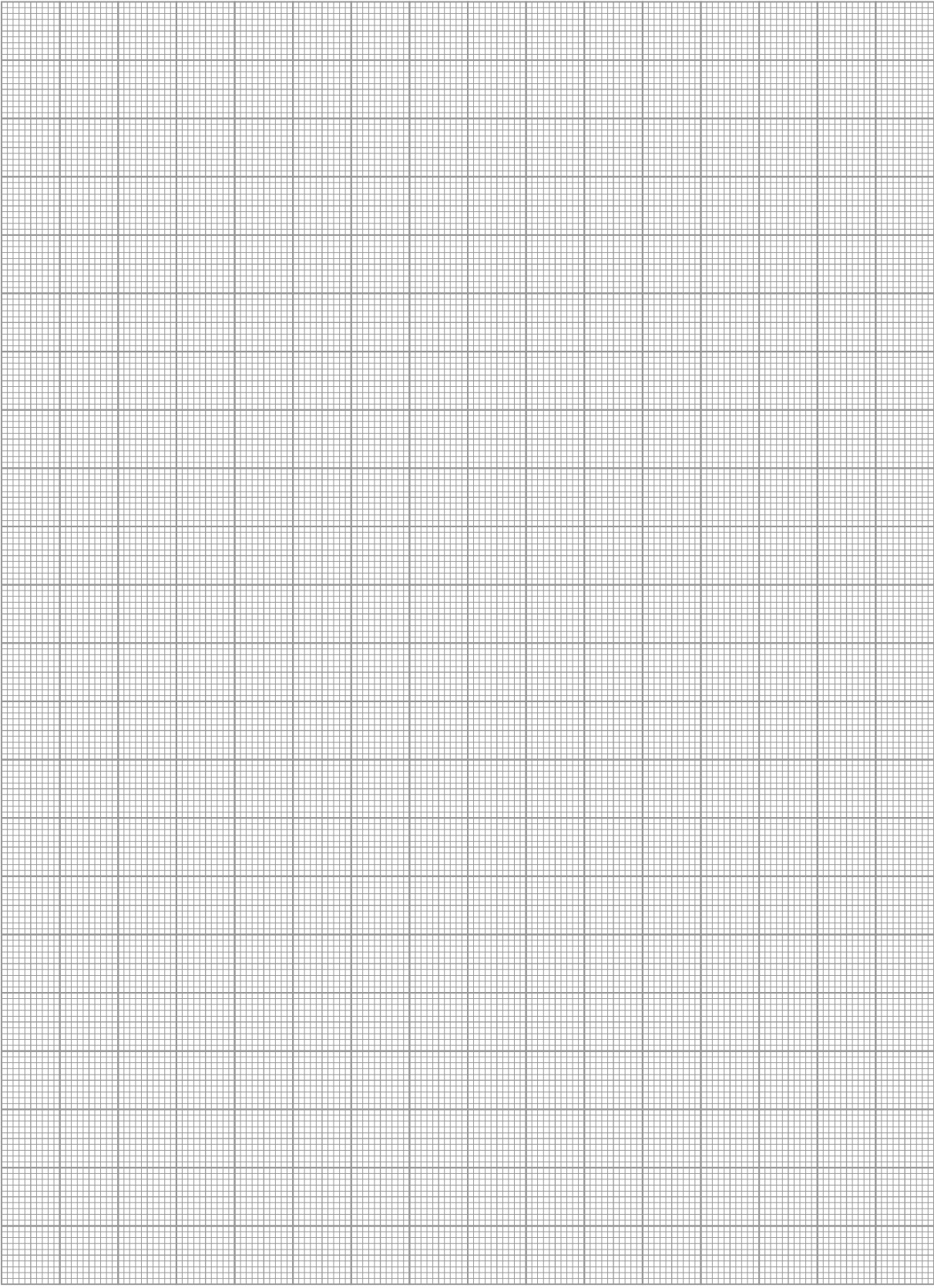

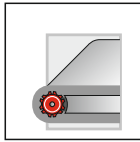

ZUBEHÖR ROLLENBAHNEN

ROLLER CONVEYOR ACCESSORIES

ACCESSOIRES CONVOYEUR A ROULEAUX



RSV-45-1A

Roller conveyor 45 ·
Convoyeur à galets 45

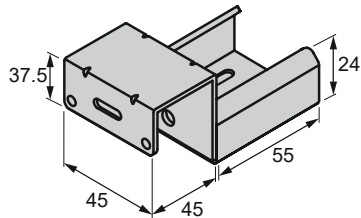

08.00111.00

RSV-45-3A

Roller conveyor 45 ·
Convoyeur à galets 45

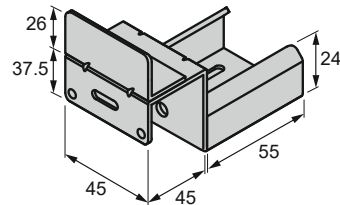

08.00113.00

RSV-45-4A

Roller conveyor 45 ·
Convoyeur à galets 45

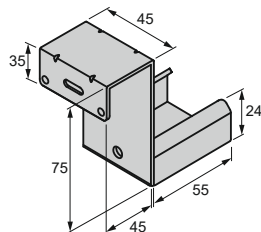

08.00115.00

RSV-40-1A

Roller conveyor 40 ·
Convoyeur à galets 40

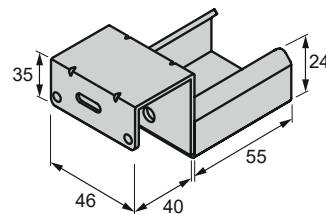

08.00127.00

RSV-40-3A

Roller conveyor 40 ·
Convoyeur à galets 40

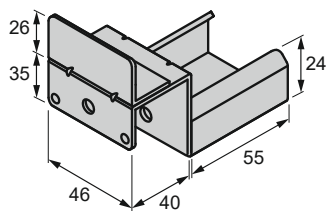

08.00107.00

RSV-40-4A

Roller conveyor 40 ·
Convoyeur à galets 40

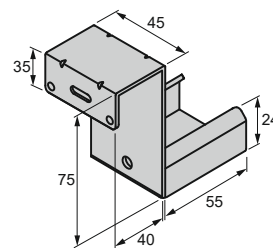

08.00125.00

RSV-40-5A

Roller conveyor 40 ·
Convoyeur à galets 40

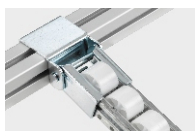
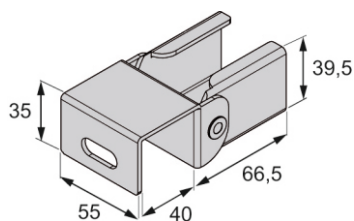

08.00710.00

RSV-40-6A

Roller conveyor 40 ·
Convoyeur à galets 40

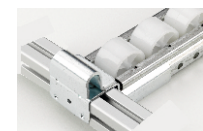
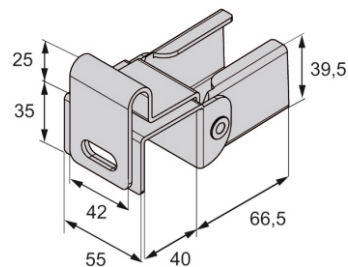

08.00711.00

Technische Änderungen vorbehalten

ZUBEHÖR ROLLENBAHNEN

ROLLER CONVEYOR ACCESSORIES

ACCESSOIRES CONVOYEUR A ROULEAUX



Schienenaufnahme

Roller conveyor ·
Convoyeur à galets

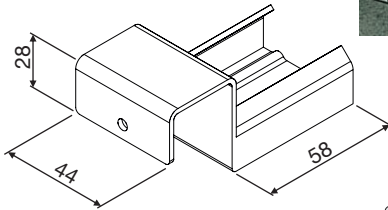

08.00100.00

mit Stopper

With stopper ·
Avec butée

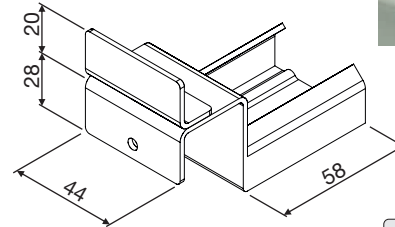

08.00102.00

Schienenaufnahme HR

Roller conveyor ·
Convoyeur à galets

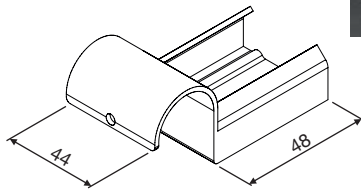
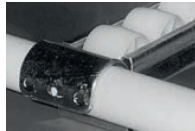

08.00108.00

mit Stopper

With stopper ·
Avec butée

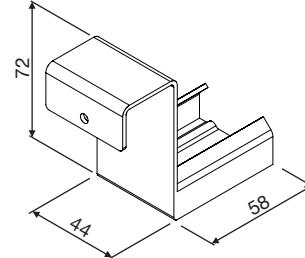

08.00114.00

Schienenverbinder

Rail connector ·
Union de rail

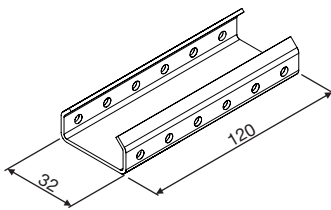

08.00104.00

mit Aufsatz

With support ·
Union de rail support

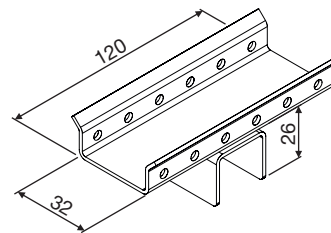

08.00106.00

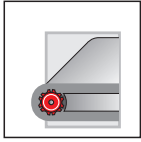

BANDFÖRDERER

CONVEYOR BELTS

CONVOYEUR A BANDE



Merkmale

- Transport von Teilen, Behältern und Werkstückträgern
- Gewichte von 0 bis 100 kg
- Förderbreite von 30 bis 2500 mm
- Förderbandqualität
 - Kunststoffkette
 - Keilriemengurte
 - Zahnriemen
 - Drahtgliedergurte
- Seitenführungs-Systeme mit:
 - Alu-Profil
 - Kunststoff-Leisten und Rundstange
 - VA-Rundstangen
 - Standardhalter aus Kunststoff und VA
- Bandkörper
 - Alu-Profile und Stahlblechauflagen
 - VA-Blechkantkonstruktion
- Bandgeschwindigkeit von 0 bis 30 m/min

Preise auf Anfrage

Characteristics

- Transportation of parts, containers and pallets
- Weights from 0 to 100 kg
- Conveying widths from 30 to 2500 mm
- Conveyor belt types
 - V-belts
 - Plastic chain (toothed belts)
 - Wire link belts
- Side guidance systems with:
 - Aluminium profiles
 - Plastic rails and round rod
 - Stainless steel rods
 - Standard container made of plastic and stainless steel body
- Belt frame
 - Aluminium profiles and sheet steel supports
 - Stainless sheet steel construction
- Belt speeds from 0 to 30m per min

Prices on request

Caractéristique

- Transport de pièces et palettes
- Poids de 0 à 100 kg
- Largeur de convoyage de 30 à 2500 mm
- Qualité de courroie
 - Chaîne plastique
 - Courroies trapézoïdales
 - Chaîne plastique (courroie dentée)
 - Courroies fil métallique
- Systèmes de rives avec:
 - Profilé alu
 - Rives plastique et baguette ronde
 - Baguettes rondes inox
 - Support standard en plastique et inox
- Corps de bande
 - Profilé alu et tôles
 - Construction en tôle inox pliée
- Vitesse de bande de 0 à 30 m/min

Offre sur mesure

Anwendungen

Applications · Applications

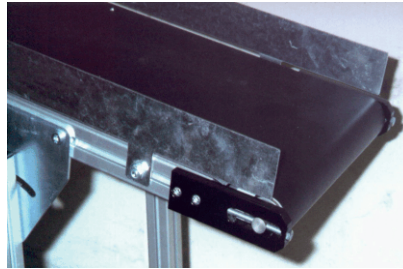
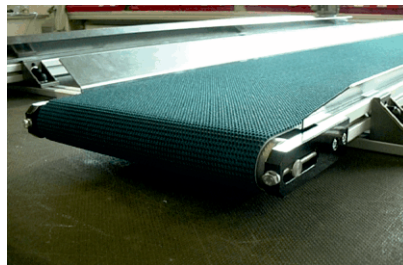

Technische Änderungen vorbehalten

BANDFÖRDERER CONVEYOR BELTS CONVOYEUR A BANDE



Darstellung

View · Vue

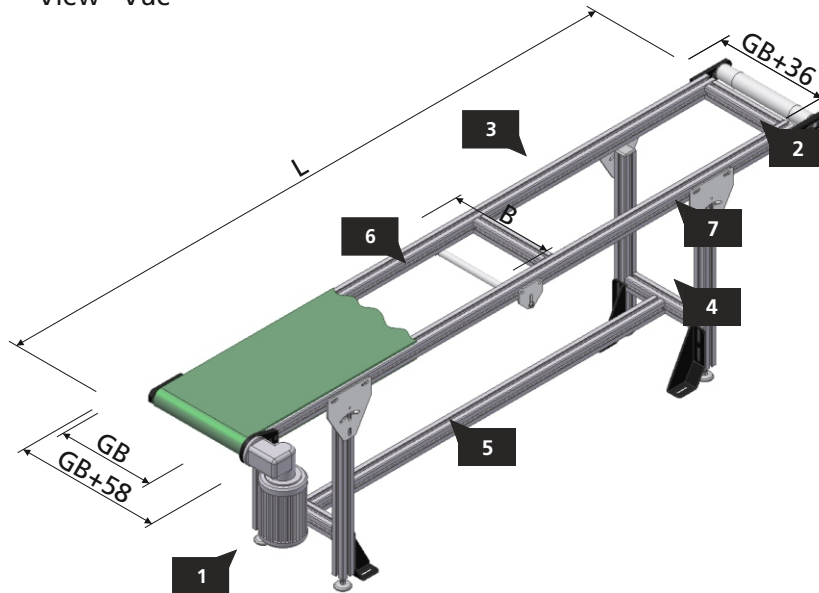

BF 30



BF 40

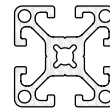

BF 60L

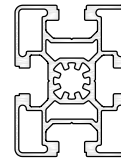

BF 80L

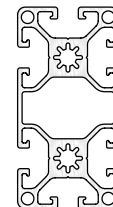

1	Antrieb	Drive	Entraînement
2	Umlenkung	Return	Renvoi
3	Bandstrecke	Belt section	Longeron
4	Bandstütze	Belt support	Piètement
5	Verbindungsstrebe	Connecting strut	Entretoise piètement
6	Stützrolle	Support roller	Rouleau support de bande
7	Halteblech	Retaining plate	Interface piètement

Technische Daten

Technical details · Caractéristiques techniques

	Bandlänge L Belt length L Longueur du convoyeur L	Gurtbreite (mm) Belt width (mm) Largeur de courroie (mm)	Bandbelastung (gesamt) Belt load (total) Charge (totale)	Bandgeschwindigkeit Belt speed Vitesse
BF 30	500-4.000 mm	100 / 150 / 200 / 250 / 300 / 400 / 500	< GB=250: max. 5kg/m (Max.15 kg) > GB=250: max. 10kg/m (Max. 30 kg)	5.4m/min , 7.3m/min 13.1m/min , 11.5m/min 15.4m/min
BF 40	500-4.000 mm	100 / 150 / 200 / 250 / 300 / 400 / 500	< GB=250: max. 5kg/m (Max.20 kg) > GB=250: max. 10kg/m (Max. 40 kg)	6.5m/min , 9.8m/min 13.1m/min
BF 60L	1.000-6.000 mm	100 / 150 / 200 / 250 / 300 / 400 / 500	< GB=400: max. 15kg/m (Max.90 kg) > GB=400: max. 20kg/m (Max. 120 kg)	7.5m/min , 9.4m/min 13.2m/min , 18.8m/min
BF 80L	1.000-12.000 mm	100 / 150 / 200 / 250 / 300 / 400 / 500	< GB=500: max. 5kg/m (Max.15 kg) > GB=500: max. 40kg/m (Max. 400 kg)	8.3m/min , 9.8m/min 12.4m/min , 15.5m/min 19.6 m/min

Technische Änderungen vorbehalten

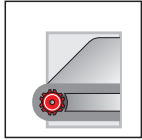

3D-KETTENFÖRDERER

3D CHAIN CONVEYOR

CONVOYEUR A CHAINE 3D



Merkmale

Geeignet für den universellen und flexiblen Transport von vielen Produkten im:

Direkttransport

z.B. Lagerringe, Verzahnungsteile, Schachteln, Flaschen, Kartons, usw.

Werkstückträger Systeme

Für leichte Teile bei universellen Förderverlauf wie Kurven, Steigungen, Gefällstrecken, usw.

Baukastensystem

Mit allen erforderlichen Elementen wie Antriebsstationen, Umlenkstationen, Kurven, Bogenrädern, Vereinzeler, Stopper, Fixierstation, usw.

Characteristics

Suitable for universal and flexible transport of large numbers of products:

Direct transport

E.g. bearing rings, gearing parts, boxes, bottles, cartons etc.

Workpiece carrier conveying systems

For light parts with universal transport tracks such as bends, inclines, slopes etc.

Modular system

With all necessary elements such as drive stations, turning stations, bends, separators, stoppers, fixing stations etc.

Caractéristique

Pour le transport universel et flexible de nombreux produits:

Transport direct

Par ex. anneaux, éléments d'engrenage, boîtes, bouteilles, cartons

Systèmes de palettes

Pour pièces légères sur tracés universels en courbes, montées, déclivités, etc.

Système modulaire

Avec tous les éléments nécessaires tels que stations d'entraînement, de renvoi, courbes, butées, stations de fixation, etc.

Teilegewichte Parts weight Poids des pièces	Bandgeschwindigkeit Belt speed Vitesse du convoyeur	Umgebungstemperatur Ambient temperature Température ambiante
1-15 (20) kg	6-12 (15) m/min	5-60 °C

Anwendungen

Applications · Applications

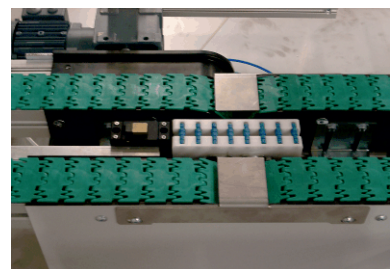
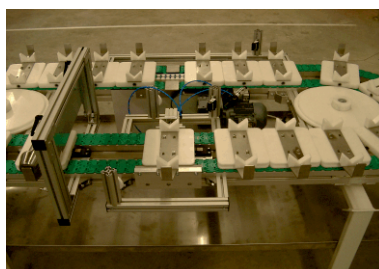
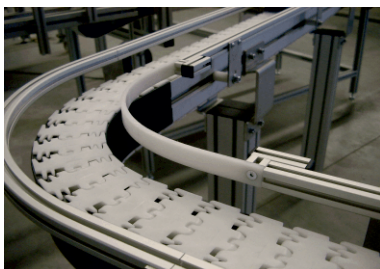
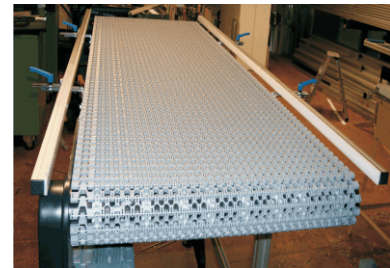
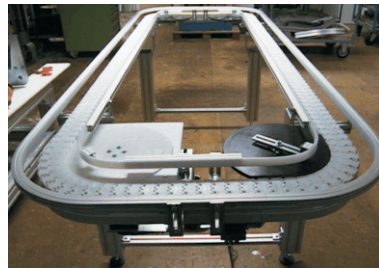
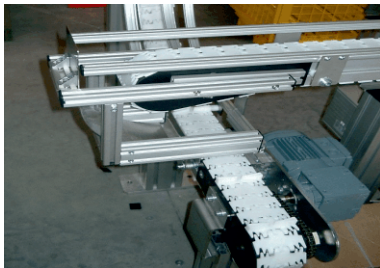
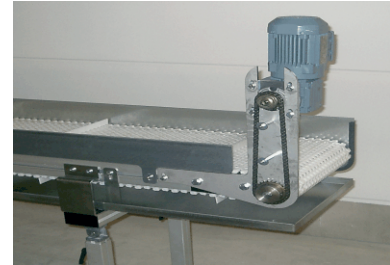

Technische Änderungen vorbehalten

3D-KETTENFÖRDERER 3D CHAIN CONVEYOR CONVOYEUR A CHAÎNE 3D



Führungsprofil

Guide profile · Profilé de guidage

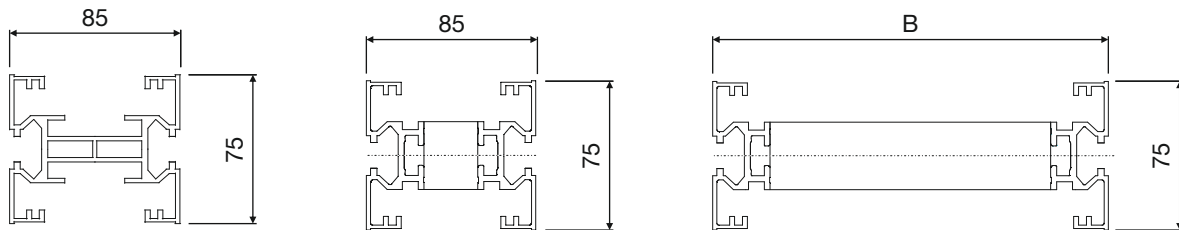
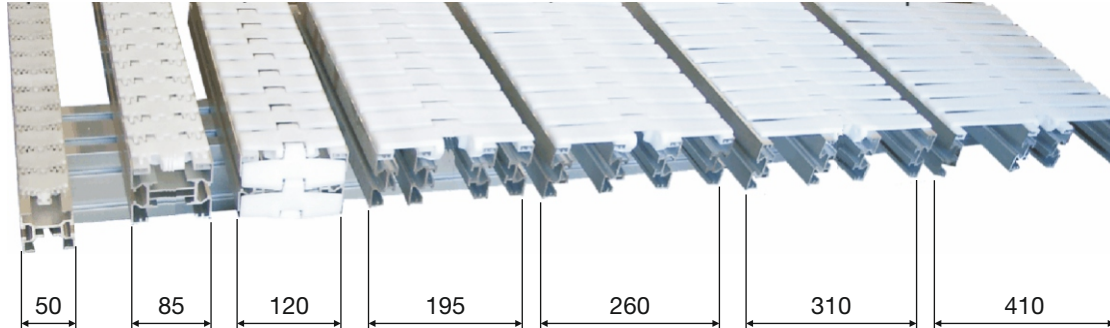

Typ

Type · Type



Typ FK-3 Kunststoffkette
Type FK-3 plastic chain
Type FK- chaîne plastique

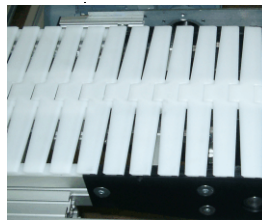

Typ FG-3 Kunststoffglieder
Type FG-3 plastic links
Type FG-3 maillons plastique

Auslegungsdaten

Design data · Caractéristiques

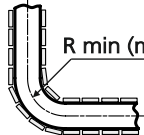
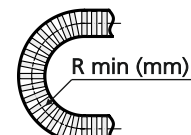
Typ	Kettenbreite Chain width Largeur de chaîne	Führungsprofil (BxH) Guide profile (BxH) Profilé de guidage (BxH)	R min (mm)	
				
FK-3	48	50 x 50	150	300
FK-3	64	70 x 75	200	400
FK-3	82	85 x 75	200	400
FK-3	89	90 x 75	500	500
FK-3	114	120 x 75	200	400
FG-3	82	85 x 75	150	400
FG-3	112	120 x 75	200	400
FG-3	209	215 x 75	350	400
FG-3	311	320 x 75	600	500
FG-3	373	380 x 75	700	500
FG-3	453	460 x 75	850	500
FG-3	577	585 x 75	1.100	600
FG-3	618	625 x 75	1.200	600

Technische Änderungen vorbehalten

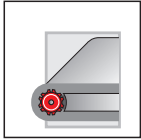

DOPPELGURT BAND DG-0 / DG-2

TWIN BELT DG-0 / DG-2

TRANSFERT A BANDES JUMEELES DG-0 / DG-2



Merkmale

- Werkstückträgersystem als Automatisierungsförderer
- Komplettsystem mit Vereinzeler, Stopper, Hub-Quertransport, Hubstation, Indexierstation, Drehstationen, usw.
- Sonderausführungen nach Aufgabenstellung

Characteristics

- Workpiece carrier transport system as automatic conveyer
- Complete system with separator, stopper, lift/cross transport, lift station, indexing station, turning station etc.
- Special designs according to requirements

Caractéristique

- Système de palettes convoyeur d'automation
- Système complet avec butées, levage et déplacement transversal, stations de levage, d'indexation, giratoires, etc.
- Versions spéciales selon les exigences

Anwendungen

Applications · Applications

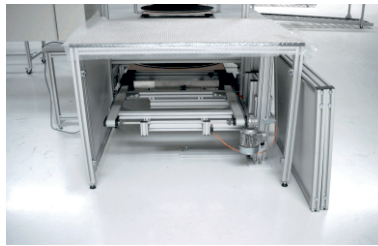
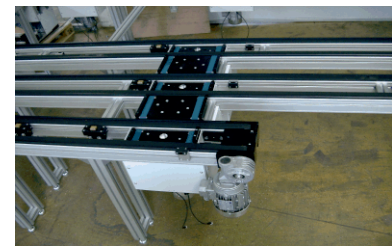
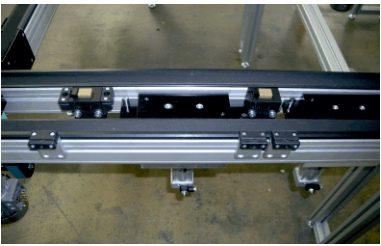
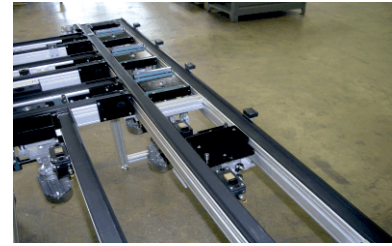
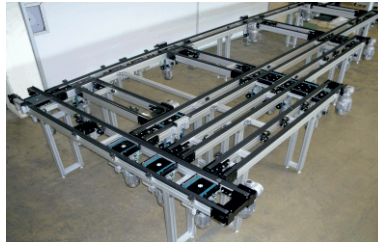

DG-2: 1 Profil - 4 Systeme

DG-2: 1 profile - 4 systems · DG-2: 1 profilé - 4 systèmes

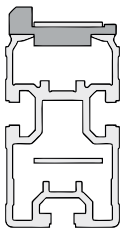

➔ ■ 13.17

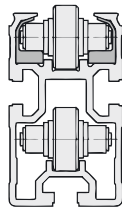

➔ ■ 13.20

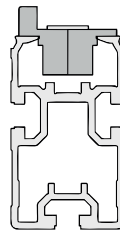

➔ ■ 13.21

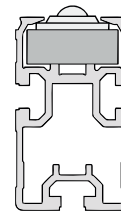

Technische Änderungen vorbehalten

DOPPELGURT BAND DG-0 / DG-2

TWIN BELT DG-0 / DG-2

TRANSFERT A BANDES JUMEELES DG-0 / DG-2



DG-0

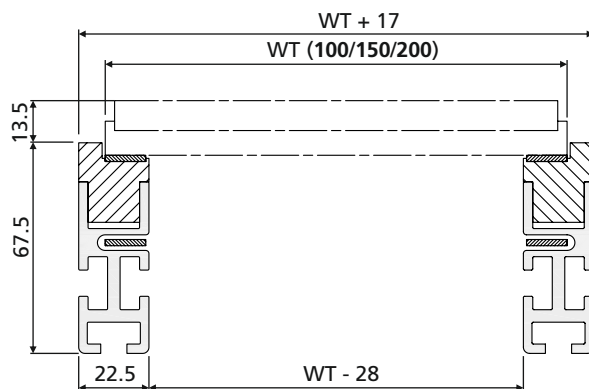

Förderprofil DG-0

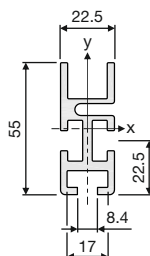
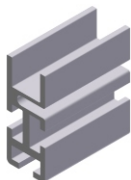

02.00068.00

M = 1.35 kg/m

PE (m)
6 / 48 / 96 / 144

DG-2

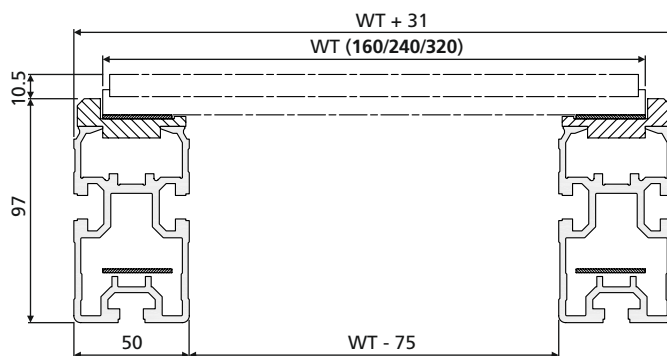

Förderprofil DG-2

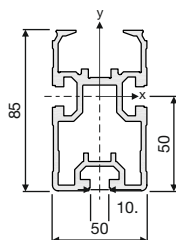
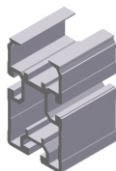

05.01020.00

M = 3.09 kg/m

PE (m)
6 / 24 / 48 / 72

Technische Daten

Technical details · Caractéristiques techniques

Typ	Werkstückträger Workpiece carriers Porte-pièce	Bandgeschwindigkeit Belt speed Vitesse	Nutzlasten Rated load Charges utiles
DG-0	100x100 / 150x150 / 200x200	9, 12, 15 m/min	1-3 kg
DG-2	160x160 / 240x240 / 320x320		3-20 kg

Technische Änderungen vorbehalten

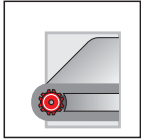

FRIKTIONSROLLENBAHN

FRICITION ROLLER CONVEYORS

CONVOYEUR A ROULEAUX A FRICTION



Merkmale

- Staurollenbahn mit außenliegenden, abgedeckten Friktionselementen (geeignet für Nassbereich)
- Werkstückdirekt-Transport mit Vulkolan-Rollenbeschichtung:
Bsp.: - Zylinderkopf
- Motorenblock
- Bremscheiben
- Kupplungsscheiben, usw.
- Behälter-Transporte im Bereich Waschmaschinen
- Werkstückträger-Transporte G bis 250 kg
- Geschwindigkeiten V bis 6 m/min
- Einzeler, Stopper, Indexierstation, Weichen, Drehstationen, Flipper, Hubstationen, Speicherfunktion
- Angepasste Förderrollenausführung
- Vulkanbeschichtet
- Gekantete Rollen
- VA-Rollen
- Verschiedene Seitenführungssysteme
- Stützenkonstruktion mit:
- Alu-Profilen
- Stahlstützen
- Tropfwannen
- Hub-Quer-Einheit
- Drehtische

Characteristics

- Accumulator roller conveyor with outer covered friction elements (suitable for wet areas)
- Workpiece direct transport with vulcanised roller coating:
E.g.: - cylinder head
- engine block
- brake plates
- clutch plates etc.
- Container transport in area of washing machines
- Workpiece transport G up to 250 kg
- Speeds V up to 6 m per min
- Separator, stopper, indexing station, points, turning stations, flippers, lifting stations, memory function
- Customised conveyor roller design
- Vulcanised coating
- Bevelled rollers
- Stainless steel rollers
- Various side guidance systems
- Support construction with:
- Aluminium profiles
- Steel supports
- Drip trays
- Lift transverse unit
- Turntable

Caractéristique

- Convoyeur d'accumulation à rouleaux, éléments de friction recouverts (convient en atmosphère humide)
- Transport direct de pièces à usiner, avec enduction vulcanisée des rouleaux
Ex. : - tête cylindrique
- bloc moteur
- disques frein
- disques d'embrayage, etc.
- Transport de récipients dans le secteur des machines à laver
- Transport direct de platines transfert G max. 250 kg
- Vitesses V max. 6 m/min
- Butées, stoppeurs, stations d'indexation, aiguillages, stations giratoires, centrage, levage, accumulation
- Version adaptée des rouleaux
- Enduction vulcanisée
- Rouleaux chanfreinés
- Rouleaux inox
- Divers systèmes de rives
- Piètements avec :
- Profilés alu
- Pieds acier
- Égouttoirs
- Unité de levage transversale
- Tables tournantes

Anwendungen

Applications · Applications

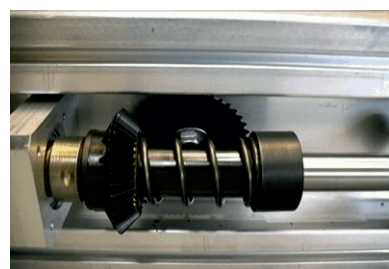
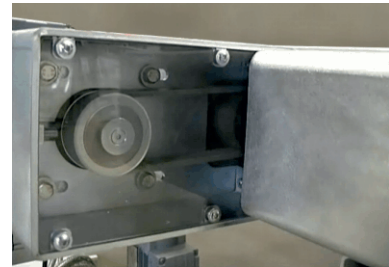
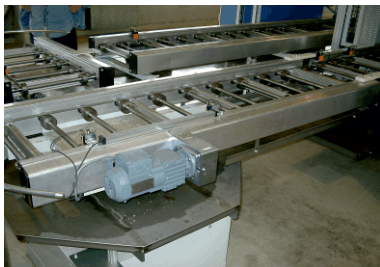

FRIKTIONSROLLENBAHN

FRICITION ROLLER CONVEYORS

CONVOYEUR A ROULEAUX A FRICTION



Rollenbahnprofil

Roller conveyor profile · Profilé pour convoyeur à rouleaux

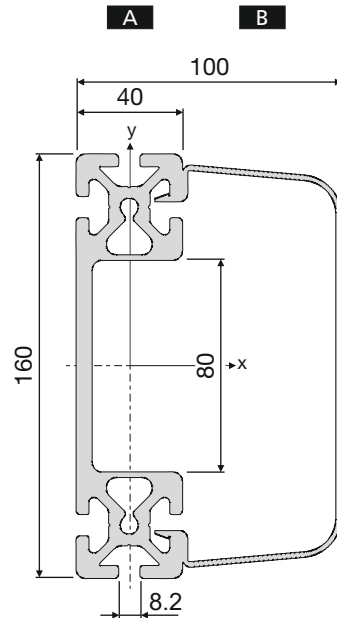
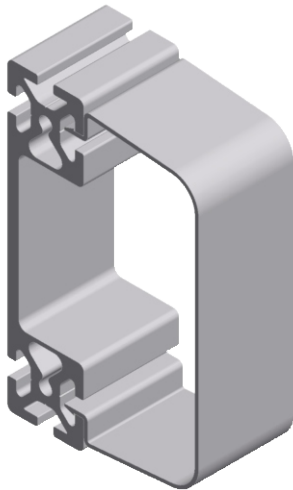

05.01983.00

M= 6.20 kg/m

PE (m)
6 / 12 / 24 / 36



05.01937.00

M= 6.20 kg/m

PE (m)
6 / 12 / 24 / 36



05.01938.00

Abdeckung
Cap
Cache

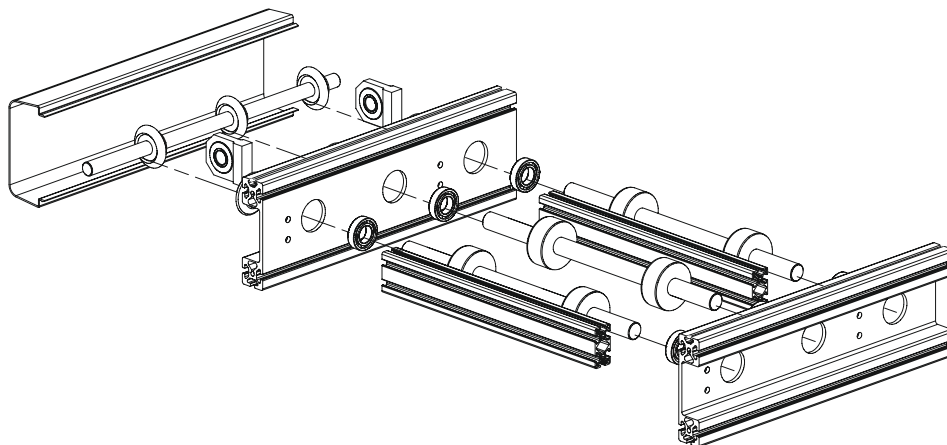

Technische Daten

Technical details · Caractéristiques techniques

Bahnweite L Belt width Largeur de bande	Ø Rollen Ø Roller Ø Rouleau	Rollenteilung Roller pitch Entraxe rouleaux	Max. Bel. / Rolle Max. load per roller Charge max. / rouleau	Max. Stückgewicht Max. piece weight Poids unitaire max.
200-1200 mm	nach Bedarf	110 mm / 140 mm Sonder /Special/Spéciale	100 kg	300 kg

Technische Änderungen vorbehalten

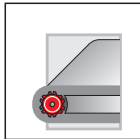

STAUKETTENTRANSFER SK-4

ACCUMULATOR CHAIN TRANSFER SK-4

TRANSFERT A CHAÎNE D'ACCUMULATION SK-4



Merkmale

- Werkstückträgersystem als Automatisierungsförderer
- Komplettsystem mit Vereinzeler, Stopper, Hub-Quertransport, Hubstation, Indexierstation, Drehstationen, usw.
- Sonderausführungen nach Aufgabenstellung
- Geeignet für Automatikumläufe
- Teilautomatische Umläufe
- Manuelle Schiebestrecken
- Für Wt's / Paletten / Behälter

Characteristics

- Workpiece carrier transport system as automatic conveyer
- Complete system with separator, stopper, lift/cross transport, lift station, indexing station, turning station etc.
- Special designs according to requirements
- Suitable for automatic circuits
- Semiautomatic circuits
- Manual pusher tracks
- For WPC / pallets / containers

Caractéristique

- Système de platines transfert comme convoyeur d'automatisme
- Système complet avec butées, stoppeurs, levage et déplacement transversal, station de levage, station d'indexation, giratoires, etc.
- Versions spéciales selon les exigences
- Adapté pour circuits automatisés
- Circuits semi-automatisés
- Tracés à poussée manuelle
- Pour platines transfert / palettes / récipients

Anwendungen

Applications · Applications

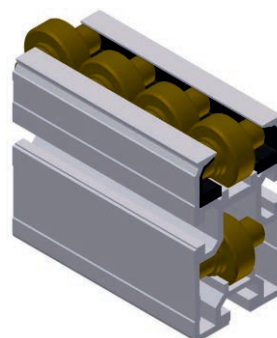
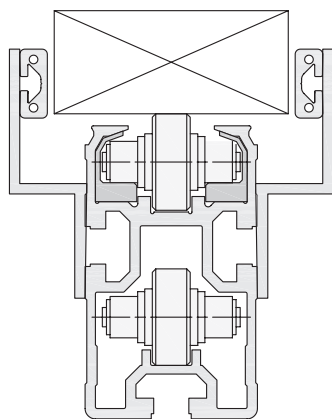

Systemquerschnitt SK-4

System cross section SK-4 · Section du système SK-4

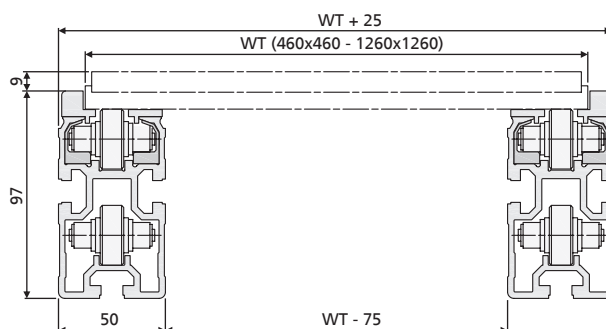

Technische Daten

Technical details · Caractéristiques techniques

Typ	Werkstückträger Workpiece carrier Porte-pièce	Bandgeschwindigkeit Belt speed Vitesse	Nutzlasten Rated loads Charges utiles
SK-4	460 x 460 - 1.260 x 1.260 mm	6 - 12 m/min	25 - 160 kg

Technische Änderungen vorbehalten

ROLLENEINSATZ

ROLLER INSERT

ELEMENT A GALETS



Innovative Vorteile

- Wirtschaftliche Lösung für manuelle Schiebetransporte
- Schnelle und leichte Montage durch Einschnappkante
- zulässige Last 15N pro Element

- Einsatz:
Streckenprofil SPR → ■ 13.02
und
Transferprofil DG-2 → ■ 13.17

Innovative advantages

- Economic solution for manual slide transport
- Fast and easy assembly with snapon edges
- Permitted load 15N per element

- Insert:
Line profile SPR → ■ 13.02
and
Transfer profile DG-2 → ■ 13.17

Atouts novateurs

- Solution pour convoyage gravitaire
- Montage rapide et aisé par encliquetage
- Charge admissible 15N par élément

- Application :
Profilé galet SPR → ■ 13.02
et
Profilé transfert DG-2 → ■ 13.17

Ausführung

- PA, antistatisch, schwarz

Design

- PA, antistatic, black

Version

- PA, antistatique, noir

ohne Bord

Without board · Sans épaulement

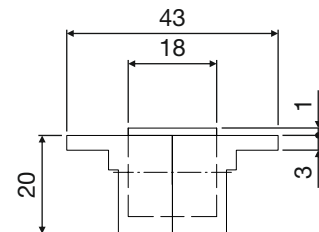
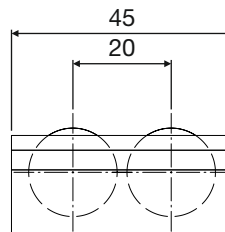
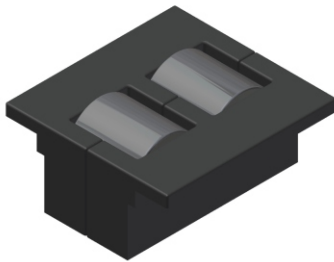

antistatisch
antistatic
antistatique

05.01191.00

mit Bord

With board · Avec épaulement

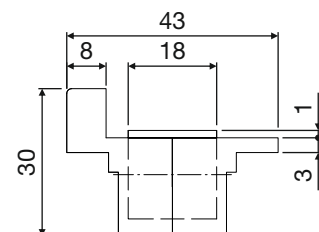
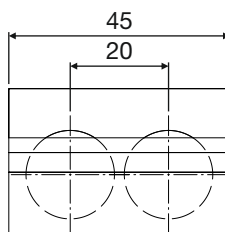
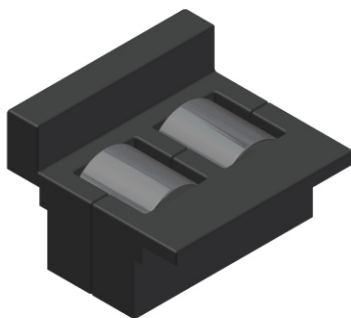

antistatisch
antistatic
antistatique

05.01189.00

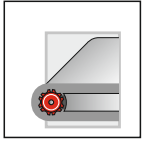

ROLLENEINSATZ ROLLER INSERT ELEMENT A GALETS



Anwendungen

Applications · Applications

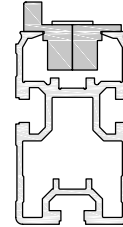
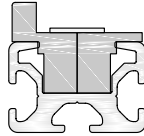
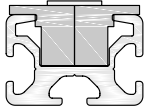

WERKZEUGE UND VORRICHTUNGEN
TOOLS AND APPLIANCES
OUTILS ET DISPOSITIFS



20



■ 14.02

30



■ 14.03

40



■ 14.04

45



■ 14.05

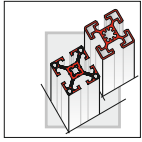

WERKZEUGE UND VORRICHTUNGEN
TOOLS AND APPLIANCES
OUTILS ET DISPOSITIFS

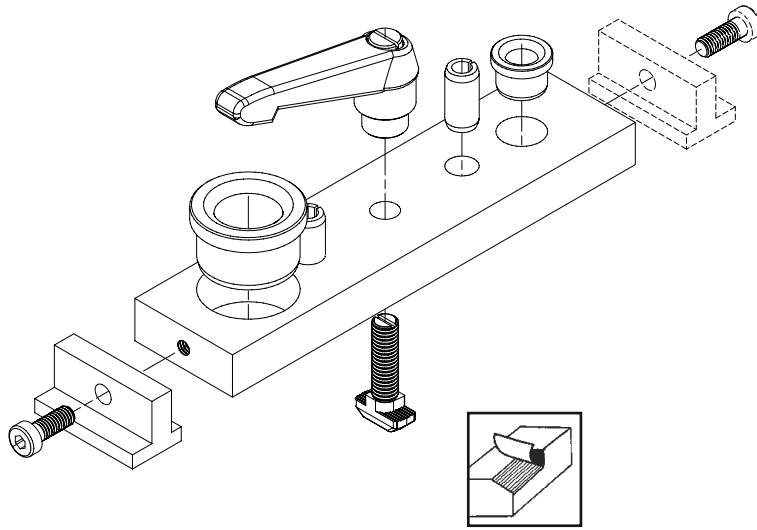

5-VS-10



05.01793.00

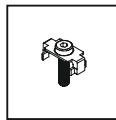

➔ ■ 3.21

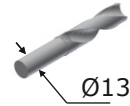
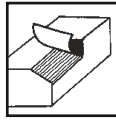

Ø13

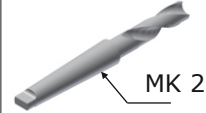

MK 2



05.02357.00



05.02358.00

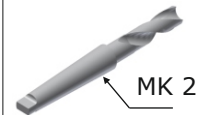
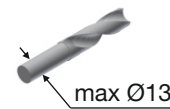
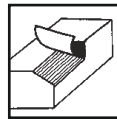
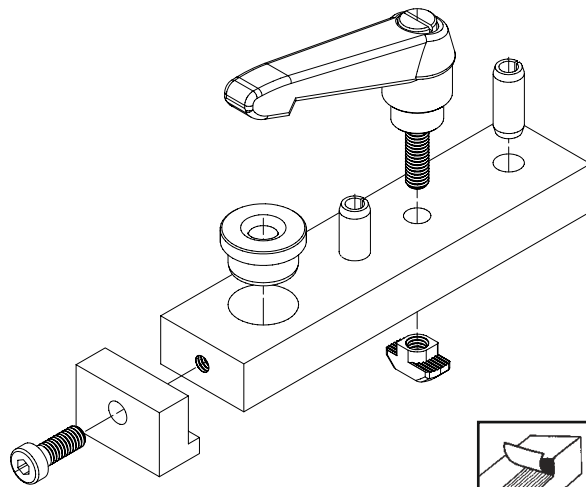

8E-AGV-5.4



05.01274.00

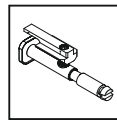

➔ ■ 3.04

05.02181.00

8E-GV-10.5



05.02162.00

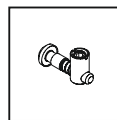

➔ ■ 3.02

05.02178.00

8E-BV-11



05.01390.00

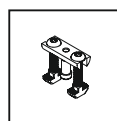

➔ ■ 3.06



05.02360.00



05.02361.00

8E-VS-14



05.01288.00

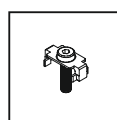

➔ ■ 3.21



05.02362.00

05.02362.02



05.02363.00

05.02363.02

8E-UNI-16



05.02171.00

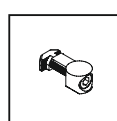

➔ ■ 3.11

05.02191.00

05.02191.02

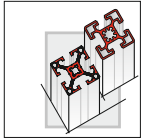

WERKZEUGE UND VORRICHTUNGEN
TOOLS AND APPLIANCES
OUTILS ET DISPOSITIFS



40

8

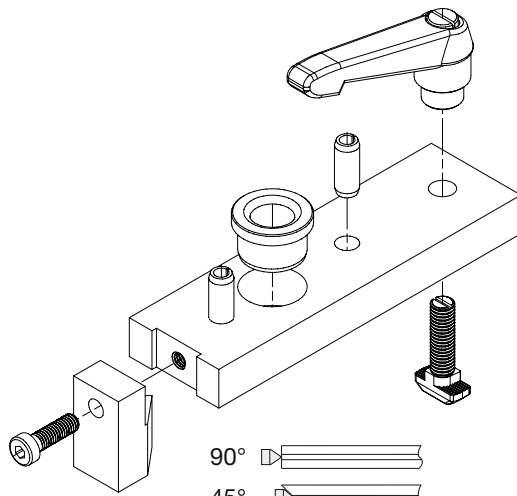

90°
45°

Kernlochbohrer
Drill bit
Foreur

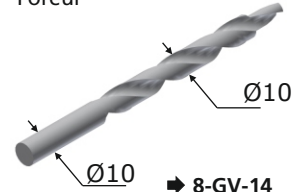

➔ 8-GV-14

05.02184.00

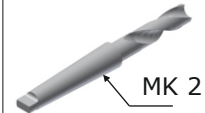
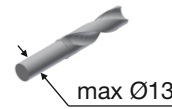

8-AGV-7.5



05.02365.00

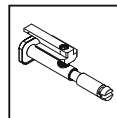

➔ ■ 3.04

05.02181.00

8-GV-14



05.02166.00

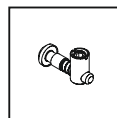

➔ ■ 3.02

05.02183.00

05.02183.02

8-BV-14



➔ 8-VS-14

05.02167.00

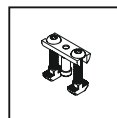

➔ ■ 3.06



05.02185.00

05.02185.02



05.02185.10

05.02185.12

8-VS-14



➔ 8-BV-14

05.02167.00

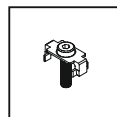

➔ ■ 3.21



05.02185.00

05.02185.02



05.02185.10

05.02185.12

8-UNI-20



➔ 10-UNI-20

05.02168.00

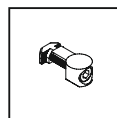









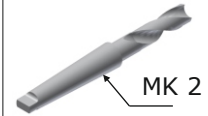
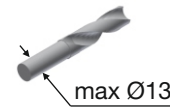
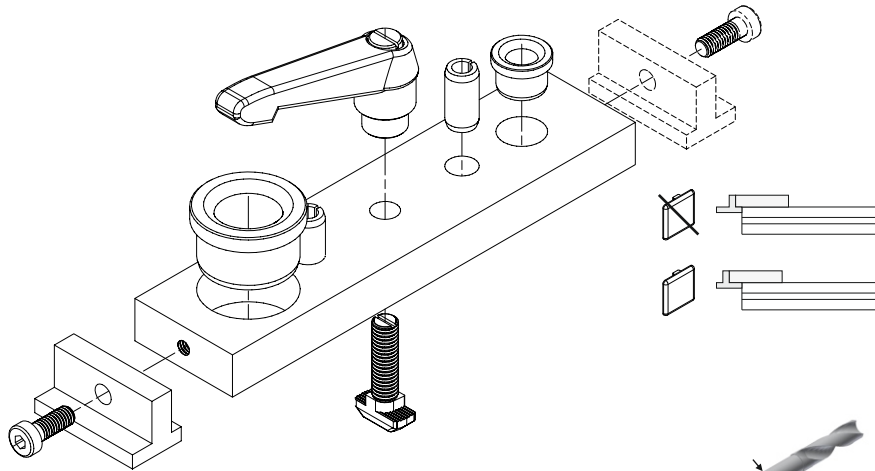

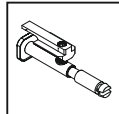
➔ ■ 3.11

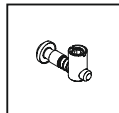
05.02186.00

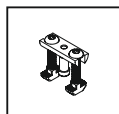
05.02186.02

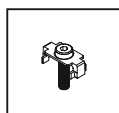
Technische Änderungen vorbehalten

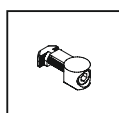

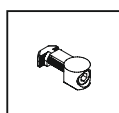
<p>10-AGV-9.5</p>	 <p>05.02366.00</p>	 <p>➔ ■ 3.04</p>	<p>05.02367.00</p>	
<p>10-GV-16</p>	 <p>05.02169.00</p>	 <p>➔ ■ 3.02</p>	<p>05.02187.00</p>	<p>05.02187.02</p>
<p>10-BV-17</p>	 <p>05.02170.00</p>	 <p>➔ ■ 3.06</p>	 <p>05.02188.00</p>	<p>05.02188.02</p>
<p>10-VS-20</p>	 <p>05.02368.00</p>	 <p>➔ ■ 3.21</p>	 <p>05.02369.00</p>	<p>05.02369.02</p>
<p>10-UNI-20</p>	 <p>➔ 8-UNI-20 05.02168.00</p>	 <p>➔ ■ 3.11</p>	 <p>05.02370.00</p>	<p>05.02370.02</p>
<p>10-UNI-20</p>	 <p>➔ 8-UNI-20 05.02168.00</p>	 <p>➔ ■ 3.11</p>	<p>05.02186.00</p>	<p>05.02186.02</p>

Technische Änderungen vorbehalten

NOTIZEN
NOTES
NOTATION

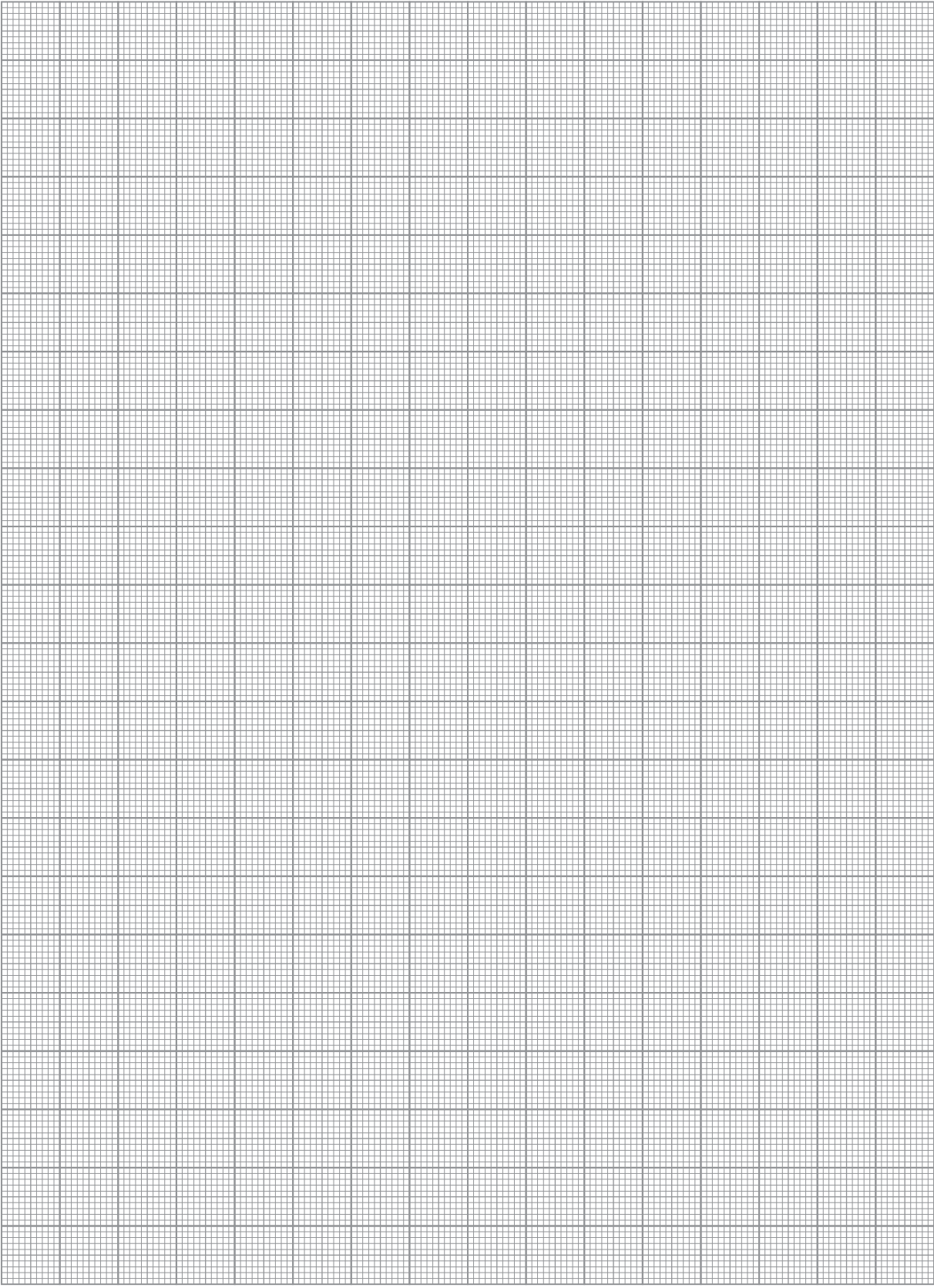

Technische Änderungen vorbehalten

ÜBERSICHT BESTELLNUMMERN

PARTNUMBER OVERVIEW

INDEX



■ 15.11



■ 15.12



■ 15.13

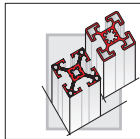

ÜBERSICHT BESTELLNUMMERN

PARTNUMBER OVERVIEW

INDEX



02.00068.00 13.17	05.01009.00 2.67	05.01053.50 3.26	05.01101.00 3.31
03.00510.00 13.03	05.01010.00 2.67	05.01054.00 3.26	05.01102.00 3.27
03.00511.00 13.03	05.01011.00 2.67	05.01054.50 3.26	05.01103.00 3.27
03.00512.00 13.03	05.01012.00 2.59	05.01055.00 3.26	05.01104.00 3.27
03.00513.00 13.03	05.01013.00 2.63	05.01056.00 3.26	05.01104.50 3.27
03.00514.00 13.03	05.01014.00 2.63	05.01057.00 3.26	05.01105.00 3.27
03.00517.00 13.03	05.01015.00 2.67	05.01059.00 3.26	05.01106.00 3.27
03.00517.06 13.03	05.01016.00 2.68	05.01063.00 3.30	05.01106.50 3.27
03.00517.08 13.03	05.01017.00 2.68	05.01064.00 3.31	05.01107.00 3.27
03.00520.00 13.06	05.01018.00 2.68	05.01064.50 3.31	05.01107.50 3.27
03.00520.08 13.06	05.01019.00 2.69	05.01065.00 3.31	05.01108.00 4.03
03.00540.30 13.03	05.01020.00 13.17	05.01065.50 3.31	05.01108.05 4.03
03.00540.40 13.03	05.01021.00 13.02	05.01066.00 3.31	05.01109.00 4.03
03.00540.50 13.03	05.01023.00 11.19	05.01066.50 3.31	05.01110.00 3.03
03.00541.30 13.03	05.01024.00 2.10	05.01067.00 3.31	05.01111.00 3.03
03.00541.40 13.03	05.01025.00 2.15	05.01067.50 3.31	05.01112.00 3.03
03.00541.50 13.03	05.01026.00 2.31	05.01068.00 3.31	05.01113.00 3.03
03.00880.00 13.06	05.01027.00 2.31	05.01069.00 3.31	05.01114.00 2.45
05.00750.00 9.03	05.01028.00 2.31	05.01070.00 3.32	05.01115.00 2.45
05.00751.00 9.03	05.01029.00 2.32	05.01071.00 3.32	05.01116.00 2.45
05.00752.00 9.03	05.01030.00 12.04	05.01072.00 3.32	05.01117.00 7.10
05.00753.00 9.03	05.01031.00 12.05	05.01080.00 3.31	05.01118.00 7.10
05.00755.10 9.05	05.01032.00 8.15	05.01080.00 3.32	05.01119.00 8.04
05.00756.10 9.05	05.01033.00 5.13	05.01081.00 3.23	05.01124.00 3.17
05.00757.10 9.05	05.01034.00 2.82	05.01082.00 3.23	05.01125.00 3.17
05.00757.20 9.05	05.01035.00 2.25	05.01083.00 3.17	05.01125.50 3.16
05.00758.10 9.05	05.01036.00 2.26	05.01085.00 4.03	05.01126.00 3.16
05.00758.20 9.05	05.01037.00 2.26	05.01085.05 4.03	05.01127.00 3.17
05.00759.00 9.05	05.01038.00 2.27	05.01085.10 4.03	05.01129.00 4.03
05.00760.00 9.05	05.01040.00 3.33	05.01087.10 3.30	05.01129.05 4.03
05.00791.10 9.03	05.01041.00 2.57	05.01088.00 3.32	05.01130.05 2.25
05.00793.10 9.03	05.01043.00 2.58	05.01089.00 3.32	05.01131.00 2.25
05.00796.00 9.03	05.01044.00 2.59	05.01089.50 3.30	05.01132.00 2.25
05.00799.10 9.03	05.01045.00 2.05	05.01090.00 3.32	05.01133.00 2.41
05.00799.20 9.03	05.01046.00 2.27	05.01091.00 3.32	05.01134.00 2.41
05.00800.10 9.03	05.01047.00 2.32	05.01092.00 3.32	05.01136.00 3.21
05.00800.20 9.03	05.01048.00 8.29	05.01093.00 3.30	05.01137.00 3.20
05.00801.00 9.03	05.01049.00 7.03	05.01094.00 3.30	05.01138.00 3.27
05.01002.00 2.31	05.01049.00 8.29	05.01095.00 3.30	05.01139.00 4.07
05.01003.00 2.32	05.01050.00 3.26	05.01095.00 3.30	05.01140.00 4.06
05.01004.00 2.34	05.01051.00 3.26	05.01096.00 3.31	05.01141.00 4.07
05.01005.00 2.49	05.01051.50 3.26	05.01097.00 3.31	05.01142.00 4.06
05.01006.00 2.49	05.01052.00 3.26	05.01098.00 3.31	05.01142.05 4.06
05.01007.00 2.50	05.01052.50 3.26	05.01099.00 3.31	05.01142.10 4.06
05.01008.00 2.49	05.01053.00 3.26	05.01100.00 3.31	05.01143.00 4.06

Technische Änderungen vorbehalten

ÜBERSICHT BESTELNUMMERN

PARTNUMBER OVERVIEW

INDEX



05.01144.00 4.06	05.01181.00 6.03	05.01226.00 5.06	05.01264.00 9.10
05.01144.05 4.06	05.01182.00 6.03	05.01227.00 5.06	05.01265.00 9.10
05.01144.10 4.06	05.01183.00 6.02	05.01228.00 5.06	05.01266.00 9.10
05.01145.00 4.02	05.01184.00 6.03	05.01229.00 5.06	05.01267.00 9.10
05.01146.00 7.11	05.01185.00 6.03	05.01230.00 5.06	05.01270.00 3.03
05.01147.00 7.11	05.01187.00 7.03	05.01235.00 5.03	05.01271.00 3.03
05.01148.00 4.07	05.01188.00 6.02	05.01236.00 5.03	05.01272.00 3.03
05.01148.05 4.07	05.01189.00 13.21	05.01237.00 5.03	05.01274.00 14.03
05.01148.10 4.07	05.01191.00 13.21	05.01238.00 5.03	05.01275.00 9.10
05.01150.00 2.82	05.01192.00 6.07	05.01239.00 4.08	05.01276.00 9.10
05.01152.00 4.06	05.01193.00 6.07	05.01240.00 5.18	05.01277.00 9.10
05.01152.05 4.06	05.01197.10 7.02	05.01241.00 5.18	05.01278.00 9.10
05.01153.00 4.07	05.01197.20 7.02	05.01242.00 5.18	05.01282.01 3.07
05.01153.05 4.07	05.01198.00 7.02	05.01243.00 5.18	05.01283.01 3.07
05.01153.10 4.07	05.01204.00 5.03	05.01244.00 5.18	05.01284.01 3.07
05.01154.00 2.82	05.01205.00 5.03	05.01245.00 5.20	05.01285.00 4.02
05.01155.00 4.08	05.01206.00 5.03	05.01246.00 5.20	05.01288.00 14.03
05.01156.00 4.08	05.01207.00 5.03	05.01247.00 5.20	05.01290.00 3.18
05.01157.00 4.08	05.01208.00 5.03	05.01248.00 5.17	05.01291.00 3.18
05.01158.00 4.08	05.01209.00 5.03	05.01248.10 5.17	05.01294.00 5.07
05.01159.00 4.08	05.01210.00 5.17	05.01249.00 5.17	05.01295.00 5.07
05.01160.00 3.25	05.01211.00 5.17	05.01250.00 4.04	05.01296.00 5.07
05.01161.00 3.25	05.01212.00 5.17	05.01250.05 4.04	05.01297.00 5.07
05.01162.00 3.25	05.01213.00 5.17	05.01251.00 4.04	05.01298.00 5.07
05.01163.00 4.09	05.01214.00 5.19	05.01251.05 4.04	05.01299.00 5.07
05.01164.00 4.09	05.01215.00 5.19	05.01252.00 4.04	05.01300.05 8.02
05.01168.00 5.08	05.01216.00 5.19	05.01252.05 4.04	05.01303.00 8.05
05.01168.05 5.08	05.01217.00 5.19	05.01253.00 3.18	05.01303.11 8.05
05.01169.00 5.08	05.01218.00 5.19	05.01254.00 3.18	05.01303.12 8.05
05.01169.05 5.08	05.01218.10 5.19	05.01255.00 4.02	05.01303.13 8.05
05.01170.00 5.09	05.01219.00 5.19	05.01255.05 4.02	05.01303.14 8.05
05.01170.05 5.09	05.01220.00 5.19	05.01255.10 4.02	05.01304.40 8.36
05.01171.00 5.09	05.01221.00 3.32	05.01255.15 4.02	05.01304.45 8.36
05.01171.05 5.09	05.01222.00 4.02	05.01255.20 4.02	05.01305.40 8.36
05.01172.00 5.09	05.01222.05 4.02	05.01255.25 4.02	05.01305.45 8.36
05.01172.00 5.13	05.01222.10 4.02	05.01256.00 4.02	05.01311.00 6.02
05.01174.00 5.09	05.01223.00 8.12	05.01256.05 4.02	05.01312.00 6.02
05.01174.05 5.09	05.01223.11 8.12	05.01256.10 4.02	05.01314.00 7.08
05.01174.50 5.09	05.01223.12 8.12	05.01257.00 4.02	05.01315.00 7.08
05.01175.00 6.02	05.01223.13 8.12	05.01257.05 4.02	05.01316.00 7.08
05.01176.00 6.02	05.01224.00 8.12	05.01258.00 4.10	05.01317.00 7.08
05.01177.00 6.02	05.01224.11 8.12	05.01260.00 9.10	05.01318.00 7.08
05.01178.00 6.03	05.01224.12 8.12	05.01261.00 9.10	05.01319.00 7.09
05.01179.00 6.03	05.01224.13 8.12	05.01262.00 9.10	05.01320.00 7.09
05.01180.00 6.03	05.01225.00 5.06	05.01263.00 9.10	05.01321.00 7.09

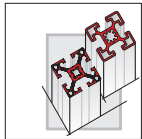

ÜBERSICHT BESTELNUMMERN PARTNUMBER OVERVIEW INDEX



05.01322.00	7.09	05.01370.00	3.33	05.01424.00	3.34	05.01472.10	3.25
05.01324.00	7.08	05.01371.00	3.33	05.01425.00	3.23	05.01478.00	2.82
05.01325.00	7.08	05.01372.00	3.33	05.01426.00	3.23	05.01480.00	5.02
05.01326.00	8.14	05.01373.00	3.33	05.01427.00	3.23	05.01480.90	5.02
05.01327.00	8.14	05.01374.00	3.33	05.01428.00	3.23	05.01481.00	5.02
05.01328.00	8.14	05.01375.00	3.33	05.01429.00	3.23	05.01482.00	5.02
05.01328.01	8.14	05.01376.00	3.33	05.01430.00	3.23	05.01483.00	5.02
05.01328.02	8.14	05.01377.00	3.33	05.01431.00	3.23	05.01484.00	5.02
05.01328.03	8.14	05.01380.00	5.19	05.01432.00	3.23	05.01484.90	5.02
05.01328.04	8.14	05.01381.00	5.19	05.01433.00	3.23	05.01485.00	5.02
05.01328.05	8.14	05.01382.00	5.19	05.01434.00	3.23	05.01486.00	5.02
05.01328.06	8.14	05.01383.00	5.19	05.01435.00	3.23	05.01487.00	5.02
05.01328.07	8.14	05.01384.00	5.19	05.01436.00	3.23	05.01488.00	5.02
05.01335.00	12.11	05.01384.10	5.19	05.01437.00	3.23	05.01489.00	5.02
05.01336.00	12.12	05.01386.00	5.19	05.01438.00	3.23	05.01490.00	5.02
05.01337.00	12.12	05.01387.00	5.19	05.01439.00	3.23	05.01490.90	5.02
05.01338.00	12.12	05.01390.00	14.03	05.01441.00	3.23	05.01491.00	5.02
05.01339.00	12.12	05.01392.00	3.20	05.01442.00	3.23	05.01492.00	5.02
05.01340.00	12.12	05.01398.00	3.33	05.01443.00	3.23	05.01493.00	5.02
05.01341.00	12.11	05.01399.00	3.33	05.01445.00	3.03	05.01494.00	3.22
05.01345.00	6.03	05.01400.00	3.21	05.01446.00	5.07	05.01495.00	3.22
05.01346.00	5.05	05.01400.00	3.23	05.01447.00	5.07	05.01496.00	3.22
05.01347.00	5.05	05.01401.00	3.23	05.01448.00	5.07	05.01497.00	3.22
05.01351.00	3.03	05.01402.00	3.23	05.01449.00	5.07	05.01498.00	2.63
05.01352.00	3.03	05.01403.00	3.23	05.01450.00	5.03	05.01499.00	2.63
05.01353.00	3.03	05.01404.00	3.23	05.01452.00	5.03	05.01500.00	3.22
05.01354.00	3.03	05.01405.00	3.23	05.01453.00	5.03	05.01502.00	3.22
05.01355.00	3.03	05.01406.00	3.23	05.01454.00	5.03	05.01503.00	3.22
05.01356.00	3.03	05.01407.00	3.23	05.01455.00	5.03	05.01504.00	3.22
05.01357.00	3.03	05.01408.00	3.23	05.01456.00	5.03	05.01505.00	3.22
05.01357.50	3.03	05.01409.00	3.23	05.01457.00	5.03	05.01505.00	3.22
05.01358.00	3.03	05.01410.00	3.23	05.01458.00	5.03	05.01506.00	3.22
05.01359.00	3.03	05.01411.00	3.23	05.01459.00	5.03	05.01507.00	3.22
05.01359.50	3.03	05.01412.00	3.23	05.01460.00	5.03	05.01508.00	3.22
05.01360.00	3.03	05.01412.00	3.23	05.01461.00	5.03	05.01509.00	3.22
05.01360.50	3.03	05.01413.00	3.23	05.01462.00	5.03	05.01510.00	8.21
05.01361.00	3.03	05.01414.00	3.23	05.01463.00	5.03	05.01511.00	8.21
05.01362.00	3.21	05.01415.00	3.23	05.01464.00	5.04	05.01512.00	8.21
05.01363.00	3.21	05.01417.00	3.23	05.01465.00	5.03	05.01517.00	2.57
05.01364.00	3.21	05.01418.00	3.23	05.01466.00	5.03	05.01518.00	2.58
05.01365.00	3.21	05.01419.00	3.21	05.01467.00	5.03	05.01520.00	5.20
05.01366.00	3.21	05.01420.00	3.34	05.01468.00	5.04	05.01521.00	5.20
05.01367.00	3.21	05.01421.00	3.34	05.01469.10	3.29	05.01522.00	5.20
05.01368.00	3.20	05.01422.00	3.34	05.01470.10	3.29	05.01523.00	3.22
05.01369.00	3.33	05.01423.00	3.34	05.01471.10	3.29	05.01524.00	5.21

Technische Änderungen vorbehalten

ÜBERSICHT BESTELNUMMERN

PARTNUMBER OVERVIEW

INDEX



05.01525.00	5.21	05.01572.00	3.21	05.01632.00	8.09	05.01672.05	8.13
05.01526.00	5.21	05.01574.00	4.10	05.01632.00	8.09	05.01672.06	8.13
05.01527.00	5.21	05.01575.00	4.10	05.01634.00	8.09	05.01672.07	8.13
05.01528.00	9.10	05.01576.00	4.10	05.01634.05	8.09	05.01673.00	8.13
05.01529.00	5.21	05.01577.00	4.10	05.01638.00	6.08	05.01673.05	8.13
05.01530.00	9.10	05.01578.00	4.11	05.01639.00	8.04	05.01673.06	8.13
05.01531.00	9.10	05.01579.00	4.11	05.01640.00	3.10	05.01673.07	8.13
05.01536.00	2.31	05.01582.00	5.22	05.01641.00	3.10	05.01674.00	8.13
05.01538.00	3.16	05.01583.00	5.22	05.01642.00	3.10	05.01674.05	8.13
05.01539.00	5.21	05.01583.10	5.22	05.01643.00	3.10	05.01674.06	8.13
05.01542.00	8.21	05.01584.00	5.22	05.01644.00	3.11	05.01674.07	8.13
05.01545.00	3.03	05.01584.10	5.22	05.01644.50	3.11	05.01678.01	3.07
05.01548.00	5.20	05.01585.00	3.03	05.01645.00	2.09	05.01679.00	3.07
05.01549.00	5.20	05.01586.00	3.03	05.01646.00	2.10	05.01680.00	3.09
05.01553.00	3.03	05.01587.00	6.02	05.01649.00	3.20	05.01680.20	3.09
05.01554.00	3.03	05.01590.00	3.03	05.01650.00	8.19	05.01681.00	5.18
05.01555.00	3.03	05.01596.00	3.03	05.01651.00	8.19	05.01682.00	3.09
05.01556.00	3.03	05.01597.00	3.03	05.01651.11	8.19	05.01682.02	3.09
05.01556.50	3.03	05.01598.00	3.03	05.01651.12	8.19	05.01682.20	3.09
05.01557.00	3.03	05.01599.00	8.29	05.01651.13	8.19	05.01682.22	3.09
05.01558.00	4.12	05.01600.00	8.32	05.01652.00	3.20	05.01683.00	3.09
05.01558.05	4.12	05.01602.00	2.09	05.01652.50	3.30	05.01683.20	3.09
05.01558.06	4.12	05.01603.00	2.09	05.01653.00	3.30	05.01685.00	5.07
05.01558.07	4.12	05.01605.00	2.09	05.01653.50	3.30	05.01686.00	5.07
05.01558.20	4.12	05.01606.00	2.10	05.01654.00	3.30	05.01687.00	5.07
05.01558.50	4.12	05.01607.00	2.11	05.01654.50	3.30	05.01688.00	5.07
05.01560.00	3.20	05.01608.00	3.11	05.01655.00	3.29	05.01689.00	3.09
05.01561.00	3.20	05.01609.00	3.11	05.01656.00	3.29	05.01689.02	3.09
05.01562.00	3.20	05.01609.50	3.11	05.01658.00	2.10	05.01689.20	3.09
05.01564.00	4.14	05.01610.00	3.11	05.01659.00	2.11	05.01689.22	3.09
05.01564.05	4.14	05.01610.50	3.11	05.01660.00	3.27	05.01690.00	6.06
05.01564.06	4.14	05.01618.00	3.20	05.01661.00	3.27	05.01691.00	6.06
05.01564.07	4.14	05.01619.00	3.20	05.01662.00	3.27	05.01694.05	8.03
05.01564.50	4.14	05.01620.00	3.20	05.01663.00	2.11	05.01695.00	5.06
05.01565.00	4.14	05.01621.00	3.22	05.01664.00	2.11	05.01696.00	5.06
05.01565.05	4.14	05.01622.00	6.08	05.01665.00	8.12	05.01697.00	5.06
05.01565.06	4.14	05.01623.00	6.08	05.01667.00	8.13	05.01698.00	7.02
05.01565.07	4.14	05.01624.00	6.08	05.01668.00	8.13	05.01698.10	7.02
05.01565.50	4.14	05.01625.00	5.02	05.01669.00	8.13	05.01699.00	3.09
05.01568.00	3.25	05.01625.90	5.02	05.01670.00	8.13	05.01699.20	3.09
05.01569.00	3.25	05.01626.00	5.02	05.01671.00	8.13	05.01700.00	2.73
05.01570.00	3.21	05.01627.00	5.02	05.01671.05	8.13	05.01702.00	2.73
05.01570.00	9.03	05.01628.00	5.02	05.01671.06	8.13	05.01703.00	2.73
05.01571.00	3.21	05.01629.05	8.02	05.01671.07	8.13	05.01705.00	2.77
05.01571.12	9.05	05.01630.05	8.02	05.01672.00	8.13	05.01706.00	2.77

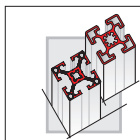

ÜBERSICHT BESTELNUMMERN PARTNUMBER OVERVIEW INDEX



05.01707.00	2.77	05.01764.00	3.09	05.01819.00	2.33	05.01856.20	4.13
05.01709.00	2.52	05.01764.20	3.09	05.01820.00	2.33	05.01856.50	4.13
05.01710.00	2.52	05.01766.00	3.09	05.01823.00	2.35	05.01857.00	4.13
05.01711.00	8.30	05.01766.20	3.09	05.01824.00	2.35	05.01857.05	4.13
05.01714.00	12.08	05.01767.00	3.09	05.01826.00	5.06	05.01857.06	4.13
05.01715.00	12.08	05.01768.00	3.09	05.01827.00	5.06	05.01857.07	4.13
05.01716.00	12.08	05.01768.20	3.09	05.01828.00	5.06	05.01857.20	4.13
05.01719.00	6.06	05.01769.00	3.09	05.01830.00	7.03	05.01857.50	4.13
05.01720.00	6.03	05.01769.02	3.09	05.01831.00	7.03	05.01859.00	7.03
05.01721.00	6.03	05.01769.20	3.09	05.01832.00	7.03	05.01865.00	7.03
05.01723.00	6.03	05.01769.22	3.09	05.01833.00	7.03	05.01866.00	2.36
05.01724.00	6.02	05.01770.00	3.09	05.01836.00	7.03	05.01867.00	2.36
05.01725.00	6.02	05.01770.20	3.09	05.01837.00	7.03	05.01868.00	2.36
05.01726.00	6.02	05.01772.00	3.09	05.01838.00	7.08	05.01869.00	2.36
05.01727.00	6.02	05.01772.20	3.09	05.01839.00	7.09	05.01870.00	3.29
05.01728.00	6.02	05.01773.00	6.02	05.01840.00	3.28	05.01871.00	3.29
05.01732.00	8.09	05.01774.00	6.03	05.01841.00	3.28	05.01872.00	3.29
05.01733.00	8.09	05.01775.00	6.04	05.01842.00	3.28	05.01874.00	7.07
05.01734.05	6.05	05.01776.00	6.04	05.01843.00	3.28	05.01874.50	7.07
05.01735.05	6.05	05.01777.00	6.04	05.01844.00	5.06	05.01874.51	7.07
05.01736.05	6.05	05.01778.00	6.04	05.01845.00	5.06	05.01875.00	7.06
05.01737.05	6.05	05.01779.00	6.04	05.01846.00	5.06	05.01876.00	8.11
05.01738.00	6.03	05.01780.00	3.04	05.01847.00	7.03	05.01878.00	8.11
05.01739.00	6.03	05.01781.10	3.04	05.01848.00	7.03	05.01879.00	12.11
05.01740.00	6.02	05.01782.00	11.19	05.01850.00	7.05	05.01880.00	12.10
05.01741.00	6.02	05.01782.10	3.04	05.01851.00	7.05	05.01881.00	12.10
05.01742.00	6.02	05.01785.00	6.02	05.01852.00	4.12	05.01882.00	12.10
05.01743.00	6.02	05.01786.00	6.02	05.01852.20	4.12	05.01884.00	12.11
05.01744.00	6.02	05.01787.00	6.02	05.01852.50	4.12	05.01885.00	3.32
05.01745.00	6.02	05.01788.00	6.04	05.01853.00	4.13	05.01885.10	3.32
05.01747.00	6.02	05.01789.00	6.04	05.01853.20	4.13	05.01886.00	3.28
05.01748.00	6.02	05.01790.00	6.04	05.01853.50	4.13	05.01886.10	3.28
05.01749.00	8.30	05.01791.00	6.04	05.01854.00	4.13	05.01887.00	3.28
05.01754.30	13.05	05.01792.00	6.04	05.01854.20	4.13	05.01887.10	3.28
05.01754.40	13.05	05.01793.00	14.02	05.01854.50	4.13	05.01888.00	3.28
05.01754.50	13.06	05.01805.00	2.06	05.01855.00	4.12	05.01888.10	3.28
05.01757.00	3.04	05.01806.00	2.05	05.01855.05	4.12	05.01889.00	3.28
05.01758.00	3.22	05.01807.00	8.11	05.01855.06	4.12	05.01890.10	12.09
05.01760.00	3.09	05.01807.50	8.11	05.01855.07	4.12	05.01891.10	12.09
05.01760.20	3.09	05.01808.00	3.25	05.01855.20	4.12	05.01892.10	12.09
05.01761.00	3.09	05.01809.00	3.25	05.01855.50	4.12	05.01895.00	12.09
05.01762.00	3.09	05.01813.00	2.05	05.01856.00	4.13	05.01895.05	12.09
05.01762.02	3.09	05.01814.00	2.50	05.01856.05	4.13	05.01896.00	12.09
05.01762.20	3.09	05.01817.00	2.51	05.01856.06	4.13	05.01896.00	12.11
05.01762.22	3.09	05.01818.00	2.51	05.01856.07	4.13	05.01896.01	12.09

Technische Änderungen vorbehalten

ÜBERSICHT BESTELNUMMERN

PARTNUMBER OVERVIEW

INDEX



05.01896.02 12.09	05.01896.03 12.09	05.01896.04 12.09	05.01897.00 12.09	05.01897.00 12.10	05.01975.00 5.18	05.01976.00 5.18	05.01977.00 5.18	05.01978.00 5.18	05.01979.00 5.18	05.02039.10 11.24	05.02040.00 5.12	05.02041.00 5.12	05.02042.00 5.12	05.02042.05 5.12	05.02090.00 11.18	05.02091.00 11.18	05.02092.00 11.18	05.02093.00 11.18	05.02094.00 11.18
05.01897.01 12.09	05.01897.02 12.09	05.01897.03 12.09	05.01897.04 12.09	05.01898.00 12.10	05.01980.00 4.05	05.01980.05 4.05	05.01981.00 4.05	05.01981.05 4.05	05.01982.00 4.05	05.02043.00 5.12	05.02043.05 5.12	05.02050.00 8.20	05.02052.05 11.10	05.02052.20 11.10	05.02095.00 11.20	05.02097.00 11.20	05.02100.01 3.07	05.02100.51 3.07	05.02101.01 3.07
05.01899.00 12.12	05.01900.00 2.57	05.01901.00 2.57	05.01902.00 2.57	05.01903.00 2.57	05.01982.05 4.05	05.01983.05 13.19	05.01985.00 4.05	05.01986.00 4.05	05.01987.00 4.05	05.02052.40 11.10	05.02053.01 8.29	05.02053.05 8.29	05.02054.00 8.20	05.02054.11 8.20	05.02101.51 3.07	05.02102.01 3.07	05.02102.51 3.07	05.02103.01 3.07	05.02104.01 3.07
05.01904.00 2.58	05.01915.00 2.15	05.01916.00 2.15	05.01919.00 2.17	05.01921.00 2.17	05.01997.00 5.18	05.01998.00 5.18	05.01999.00 5.18	05.02001.20 3.30	05.02002.20 3.30	05.02054.12 8.20	05.02054.13 8.20	05.02056.00 8.09	05.02056.05 8.09	05.02057.00 8.09	05.02105.01 3.07	05.02108.00 8.09	05.02108.05 8.09	05.02109.00 8.09	05.02109.05 8.09
05.01922.00 2.17	05.01923.00 2.15	05.01924.00 2.16	05.01925.00 2.15	05.01926.00 2.21	05.02003.20 3.30	05.02014.20 11.10	05.02014.40 11.10	05.02016.10 11.13	05.02016.20 11.13	05.02057.05 8.09	05.02060.00 8.22	05.02061.00 8.22	05.02062.00 8.22	05.02063.00 8.22	05.02124.00 3.14	05.02124.10 3.14	05.02125.00 6.02	05.02127.10 3.05	05.02126.00 6.02
05.01927.00 2.21	05.01928.00 2.16	05.01931.00 2.34	05.01932.00 2.34	05.01933.00 2.16	05.02022.00 11.05	05.02023.00 11.05	05.02024.00 11.05	05.02025.00 9.06	05.02026.00 9.06	05.02064.00 8.22	05.02065.00 8.22	05.02066.00 8.22	05.02067.00 7.04	05.02068.00 7.04	05.02128.10 3.05	05.02129.00 3.05	05.02129.10 3.05	05.02130.00 12.04	05.02131.00 12.04
05.01937.00 13.19	05.01938.00 13.19	05.01940.00 2.37	05.01942.00 2.37	05.01943.00 2.32	05.02027.00 9.06	05.02028.00 9.06	05.02029.00 9.07	05.02031.00 11.05	05.02032.00 3.24	05.02069.00 7.04	05.02070.00 7.04	05.02071.00 7.04	05.02072.00 7.04	05.02073.00 3.24	05.02133.00 8.22	05.02134.00 12.05	05.02135.00 12.05	05.02136.05 12.05	05.02140.00 3.26
05.01946.00 2.81	05.01947.00 2.81	05.01948.00 8.36	05.01949.00 8.36	05.01949.10 8.36	05.02033.00 3.24	05.02034.00 11.12	05.02034.10 11.12	05.02034.20 11.12	05.02034.30 11.12	05.02074.00 3.24	05.02075.00 7.04	05.02080.00 3.14	05.02080.10 3.14	05.02085.00 8.23	05.02141.00 3.26	05.02141.50 3.26	05.02142.00 3.26	05.02142.50 3.26	05.02144.00 5.20
05.01951.00 2.81	05.01960.00 2.21	05.01964.00 7.02	05.01965.00 7.02	05.01971.00 2.81	05.02035.10 11.13	05.02035.20 11.13	05.02038.00 5.13	05.02038.05 5.13	05.02039.00 11.24	05.02086.00 8.23	05.02087.20 11.11	05.02087.40 11.11	05.02088.00 11.18	05.02089.00 11.18	05.02145.00 5.20	05.02146.00 3.14	05.02146.10 3.14	05.02147.00 3.14	05.02147.10 3.14

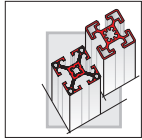

ÜBERSICHT BESTELNUMMERN PARTNUMBER OVERVIEW INDEX



05.02147.20 3.14	05.02191.00 14.03	05.02217.00 9.07	05.02251.00 11.16
05.02148.00 5.20	05.02191.02 14.03	05.02218.00 9.07	05.02252.00 4.09
05.02149.00 5.20	05.02192.00 7.06	05.02219.00 9.08	05.02268.00 9.08
05.02150.00 3.03	05.02193.00 7.06	05.02219.10 9.08	05.02269.00 9.08
05.02152.00 8.09	05.02194.00 7.06	05.02222.00 9.08	05.02271.00 3.34
05.02152.05 8.09	05.02195.00 7.08	05.02222.10 9.08	05.02273.00 3.34
05.02153.00 8.09	05.02196.00 7.08	05.02223.00 9.08	05.02275.00 3.34
05.02153.05 8.09	05.02197.00 7.08	05.02224.00 9.08	05.02276.00 3.12
05.02154.00 8.09	05.02198.00 11.23	05.02225.00 5.10	05.02276.05 3.12
05.02154.05 8.09	05.02198.05 11.23	05.02225.05 5.10	05.02276.20 3.12
05.02155.00 8.09	05.02199.00 5.10	05.02225.06 5.10	05.02276.25 3.12
05.02155.05 8.09	05.02199.05 5.10	05.02226.00 5.11	05.02277.00 3.12
05.02156.00 9.09	05.02200.00 5.11	05.02226.05 5.11	05.02277.05 3.12
05.02157.00 9.09	05.02200.05 5.11	05.02226.06 5.11	05.02277.20 3.12
05.02158.00 9.09	05.02201.10 3.21	05.02227.00 5.11	05.02277.25 3.12
05.02159.00 9.09	05.02201.20 3.21	05.02227.05 5.11	05.02279.00 3.20
05.02160.00 9.09	05.02202.10 3.21	05.02228.00 5.11	05.02280.00 11.21
05.02162.00 14.03	05.02203.00 3.12	05.02228.05 5.11	05.02280.05 11.21
05.02163.00 2.25	05.02203.05 3.12	05.02229.00 5.11	05.02281.00 11.21
05.02164.00 2.26	05.02203.20 3.12	05.02229.05 5.11	05.02281.05 11.21
05.02165.00 2.27	05.02203.25 3.12	05.02230.00 5.11	05.02282.00 11.21
05.02166.00 2.27	05.02204.00 3.12	05.02230.05 5.11	05.02282.05 11.21
05.02167.00 2.27	05.02204.05 3.12	05.02231.00 8.11	05.02283.05 8.11
05.02168.00 14.04	05.02204.20 3.12	05.02231.50 8.11	05.02284.05 8.11
05.02169.00 14.05	05.02204.25 3.12	05.02231.51 8.11	05.02285.05 8.11
05.02170.00 14.05	05.02205.00 3.13	05.02232.00 7.02	05.02286.05 8.11
05.02171.00 14.03	05.02205.05 3.13	05.02233.00 7.02	05.02287.05 8.11
05.02173.00 14.03	05.02205.20 3.13	05.02233.10 7.02	05.02288.05 8.11
05.02178.00 14.03	05.02205.25 3.13	05.02234.00 7.02	05.02289.05 8.11
05.02181.00 14.03	05.02206.00 3.13	05.02235.00 7.02	05.02290.05 8.11
05.02183.00 14.04	05.02206.05 3.13	05.02236.00 7.02	05.02291.05 8.11
05.02183.02 14.04	05.02206.20 3.13	05.02236.10 7.02	05.02292.05 8.11
05.02184.00 14.04	05.02206.25 3.13	05.02237.00 3.26	05.02293.05 8.11
05.02185.00 14.04	05.02209.00 3.13	05.02238.00 3.26	05.02294.05 8.11
05.02185.02 14.04	05.02209.05 3.13	05.02241.01 3.07	05.02295.05 8.11
05.02185.10 14.04	05.02209.20 3.13	05.02241.51 3.07	05.02296.05 8.11
05.02185.12 14.04	05.02209.25 3.13	05.02242.00 3.04	05.02297.05 8.11
05.02186.00 14.04	05.02210.00 3.13	05.02243.00 3.03	05.02298.05 8.11
05.02186.02 14.04	05.02210.05 3.13	05.02244.00 3.03	05.02299.05 8.11
05.02187.00 14.05	05.02210.20 3.13	05.02245.00 3.03	05.02300.05 8.11
05.02187.02 14.05	05.02210.25 3.13	05.02246.00 3.03	05.02301.00 8.07
05.02188.00 14.05	05.02212.05 3.13	05.02247.00 3.03	05.02301.05 8.07
05.02188.02 14.05	05.02214.00 9.06	05.02248.00 3.03	05.02302.00 8.07
05.02189.00 14.05	05.02215.00 9.07	05.02249.00 3.03	05.02302.05 8.07
05.02189.02 14.05	05.02216.00 9.07	05.02250.00 11.16	05.02303.00 8.07

Technische Änderungen vorbehalten

ÜBERSICHT BESTELNUMMERN

PARTNUMBER OVERVIEW

INDEX



05.02303.05	8.07	05.02388.00	5.05	05.02375.00	9.05	05.05072.20	8.34
05.02304.00	8.07	05.02389.00	5.05	05.02376.00	5.13	05.05073.20	8.34
05.02304.05	8.07	05.02329.00	8.27	05.02376.05	5.13	05.05221.12	11.04
05.02305.00	8.07	05.02330.00	8.27	05.02379.00	5.05	05.05221.17	11.04
05.02305.05	8.07	05.02331.00	8.27	05.02379.90	5.05	05.05221.22	11.04
05.02306.00	8.07	05.02336.00	8.29	05.02380.00	5.05	05.05221.27	11.04
05.02306.05	8.07	05.02337.00	8.29	05.02381.00	5.05	05.05222.12	11.04
05.02307.00	8.07	05.02338.00	8.29	05.02381.90	5.05	05.05222.17	11.04
05.02307.05	8.07	05.02339.00	8.29	05.02382.00	5.05	05.05222.22	11.04
05.02308.00	8.07	05.02340.00	8.31	05.02383.00	5.05	05.05222.27	11.04
05.02308.05	8.07	05.02342.00	3.22	05.02383.50	5.05	05.05252.12	11.09
05.02309.00	8.07	05.02343.00	3.22	05.02384.00	5.05	05.05252.17	11.09
05.02309.05	8.07	05.02344.00	3.22	05.02385.00	5.05	05.05252.22	11.09
05.02310.00	8.07	05.02345.00	3.22	05.02390.00	3.15	05.05252.27	11.09
05.02310.05	8.07	05.02346.00	3.22	05.02391.00	3.15	05.05452.12	11.09
05.02311.00	8.07	05.02347.00	3.22	05.02394.00	8.25	05.05452.17	11.09
05.02311.05	8.07	05.02348.00	3.22	05.02394.10	8.25	05.05452.22	11.09
05.02312.00	8.07	05.02349.00	3.22	05.02403.00	12.05	05.05452.27	11.09
05.02312.05	8.07	05.02350.00	3.22	05.02404.00	12.05	08.00001.00	10.02
05.02313.00	8.07	05.02351.00	3.22	05.02405.00	12.05	08.00002.00	10.02
05.02313.05	8.07	05.02352.00	3.22	05.02406.00	12.05	08.00003.00	10.02
05.02314.00	8.07	05.02353.00	3.22	05.02407.00	12.06	08.00004.00	10.02
05.02314.05	8.07	05.02354.00	3.22	05.02408.00	12.06	08.00005.00	10.02
05.02315.00	8.07	05.02355.00	3.22	05.02409.00	12.06	08.00007.00	10.02
05.02315.05	8.07	05.02356.00	3.22	05.02410.00	12.06	08.00008.00	10.02
05.02316.00	8.16	05.02357.00	3.22	05.02423.00	3.29	08.00009.00	10.02
05.02317.00	8.16	05.02358.00	3.22	05.02424.00	3.29	08.00010.00	10.02
05.02317.11	8.16	05.02359.00	3.22	05.02425.00	3.29	08.00011.00	10.02
05.02317.12	8.16	05.02360.00	14.03	05.02426.00	3.29	08.00013.00	10.02
05.02317.13	8.16	05.02361.00	14.03	05.02439.00	3.05	08.00016.00	10.02
05.02318.00	8.17	05.02362.00	14.03	05.02440.00	3.05	08.00017.00	10.02
05.02318.11	8.17	05.02362.02	14.03	05.02441.00	3.05	08.00018.00	10.02
05.02318.12	8.17	05.02363.00	14.03	05.05021.12	11.04	08.00019.00	10.02
05.02318.13	8.17	05.02363.02	14.03	05.05021.17	11.04	08.00019.10	10.02
05.02318.14	8.17	05.02365.00	14.04	05.05021.22	11.04	08.00020.00	10.02
05.02319.00	8.18	05.02366.00	14.05	05.05021.27	11.04	08.00021.00	10.02
05.02320.00	8.24	05.02367.00	14.05	05.05022.12	11.04	08.00022.00	10.02
05.02320.50	8.24	05.02368.00	14.05	05.05022.17	11.04	08.00023.00	10.02
05.02322.00	8.26	05.02369.00	14.05	05.05022.22	11.04	08.00026.00	10.02
05.02323.00	8.26	05.02369.02	14.05	05.05022.27	11.04	08.00027.00	10.02
05.02324.00	8.26	05.02370.00	14.05	05.05052.12	11.09	08.00029.00	10.02
05.02325.00	8.26	05.02370.02	14.05	05.05052.17	11.09	08.00030.00	10.04
05.02326.00	8.27	05.02371.00	6.03	05.05052.22	11.09	08.00030.10	10.04
05.02327.00	8.27	05.02372.00	11.22	05.05052.27	11.09	08.00031.00	10.04
05.02328.00	8.27	05.02374.00	9.03	05.05071.20	8.34	08.00031.10	10.04

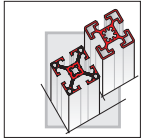

ÜBERSICHT BESTELLNUMMERN PARTNUMBER OVERVIEW INDEX



08.00032.00 10.04
08.00032.10 10.04
08.00033.00 10.04
08.00033.10 10.04
08.00034.00 10.04

08.00034.10 10.04
08.00035.00 10.04
08.00035.10 10.04
08.00036.00 10.04
08.00036.10 10.04

08.00037.00 10.04
08.00037.10 10.04
08.00038.00 10.04
08.00038.10 10.04
08.00039.00 10.04

08.00039.10 10.04
08.00040.00 10.05
08.00040.10 10.05
08.00041.00 10.05
08.00041.10 10.05

08.00042.00 10.05
08.00042.10 10.05
08.00043.00 10.05
08.00043.10 10.05
08.00044.00 10.05

08.00044.10 10.05
08.00046.00 10.05
08.00046.10 10.05
08.00048.00 10.05
08.00048.10 10.05

08.00050.00 10.05
08.00050.10 10.05
08.00090.00 13.08
08.00091.00 13.08
08.00092.00 13.08

08.00093.00 13.08
08.00100.00 13.11
08.00102.00 13.11
08.00104.00 13.11
08.00106.00 13.11

08.00107.00 13.10
08.00108.00 13.11
08.00111.00 13.10
08.00113.00 13.10
08.00114.00 13.11

08.00115.00 13.10
08.00125.00 13.10
08.00127.00 13.10
08.00153.00 10.11
08.00292.00 13.08

08.00293.00 13.08
08.00293.10 13.08
08.00293.20 13.08
08.00293.30 13.08
08.00293.40 13.08

08.00294.00 13.08
08.00294.10 13.08
08.00294.20 13.08
08.00294.30 13.08
08.00294.40 13.08

08.00298.00 13.08
08.00299.00 13.08
08.00313.00 13.08
08.00314.00 10.02
08.00315.00 10.02

08.00398.05 10.06
08.00399.00 10.06
08.00400.00 10.07
08.00411.00 10.06
08.00422.00 10.06

08.00423.10 10.06
08.00492.00 10.07
08.00493.00 10.07
08.00494.00 10.07
08.00495.00 10.07

08.00663.00 13.05
08.00664.XX 13.05
08.00710.00 13.10
08.00711.00 13.10
99.00005.00 2.37

99.00095.00 9.08
99.00274.00 2.15
99.00500.00 9.08

A		H		S	
Abdeck- und Einfassprofile	7.03	Hammermutter	3.27	Rundprofile 40	2.36
Abdeckkappen Einschlagschraube	6.04	Hammerschraube	3.24	Rundprofilssystem Ø48	11.17
Abdeckkappen Flanschmutter	3.22	Handgriff	8.14		
Abdeckkappen Kunststoff	6.02	Hartfaserplatte	7.12		
Abdeckkappen Zinkdruckguss	6.05	Höhenversteller	5.04	Schalldämmplatte	11.16
Abdeckprofil Riffelgummi	7.06	Hülsenverbinder	3.05	Schallschutz	11.15
Abdeckprofile	7.02			Scharniere	8.02
Alu - Scharnier - System	8.08	I		Scharnierlappenprofil	8.10
Aluwinkel	4.08	IR - Quick	9.10	Scharnierprofil	8.36
Anschlagpuffer	8.21	ISO - Schrauben	3.22	Schiebegleiter	8.31
Anschraubhalter	7.08			Schiebetüren	8.35
Anschraubplatte	5.22	K		Schiebetürprofil	8.29
Automatik- GV	3.04	Kabeldurchführungen	9.09	Schienenaufnahme	13.11
Automatikschraube	3.13	Kabelhalter	9.10	Schienenleiter	6.07
		Kabelkanalprofile	9.06	Schienenverbinder	13.11
B		Karabinerhaken	6.07	Schlittenprofil	12.08
Bandförderer	13.12	Kettenförderer, 3D	13.14	Schrauben- FM	3.16
Blechscharnier	8.04	Klapptüren	8.33	Schrauben- ISO	3.22
Bockrolle	5.14	Klemmhalter	7.09	Schrauben- VSA	3.20
Bodenbleche	11.21	Klemmprofil 18x32	8.30	Schrauben- VSI	3.21
Bodenplatten	5.12	Klinkengriff	8.22	Schutzzaunprofil	11.05
Bodenwinkel	5.10	Kniehebelsverschluss	8.23	Schutzzaunssystem	11.02
Bohrvorrichtungen	14.01	Knotenplatten	3.25	Schutzzaunwinkel	11.12
Bohrwerkzeuge	14.01	Kreuzplatte	3.25	Schwenktüren	8.34
Bolzenverbinder	3.06	Kugelschnäpper	8.16	Senkschrauben	3.22
Bügelgriffe	8.12	Kunststoff- Scharnier- System	8.06	Sicherheitsschalter	8.20
				Spanplatte	7.13
D		L		Staukettentransfer SK 4	13.20
Dämpfungsring	5.02	Lagereinheit	12.05	Stopper	13.03
Dichtprofile	7.04	Laschen	3.24	Streckenprofil SPR	13.02
Doppelgurtband	13.16	Laufrollen	6.08	Stützstrebe	5.13
Doppelkugelschnäpper	8.17	Lenkrollen	5.14	Stützwinkel	5.12
Doppelrolle	5.17	Linearführungssystem	12.02	Systemscharnier Alu	8.08
Doppelscharnier	8.03	Linienkopfschrauben	3.23	Systemscharnier Kunststoff	8.06
Druckluftleiste	9.02	Luftführungselemente	9.02		
				T	
E		M		Teleskopprofile	2.81
Eckelemente für Gittereinfassprofil	7.11	Magnetverschluss	8.19	Transport- und Fussplatten	5.06
Eckverbinder für Rundprofil	11.21			Transportrollen	5.14
Eckwinkel	3.14	N		Türdrücker	8.26
ECO- Rohrstecksystem	10.01	Notgriff	8.22	Türgriff	8.26
Einfass- und Abdeckprofil	7.03	Nutabdeckprofil	7.02	Türschloss	8.24
Einhängung	11.10	Nutenstein	3.29		
Einschiebemutter	3.28 / 3.32			U	
Endverbinder	3.10	P		Uni - Verbinder	3.11
		Plattenverbinder	3.08		
F		Pneumatikplatten	9.03	V	
Fadenschutz	5.21	Polycarbonat	7.12	Verbinderlaschen	3.24
Fallenverschluss	8.22	Potentialausgleich	8.21	Verbinderschraube außen	3.20
Falltürelement	8.32	Profile 16S	2.03	Verbinderschraube innen	3.21
Flächenelemente	7.12	Profile 20	2.07	Verdrehsicherung	3.34
Flanschmutter	3.26	Profile 30	2.13	Vollkunststoff	7.12
FM - Schrauben	3.16	Profile 30- 10K	2.19		
Förderprofile DG 0, DG - 2	13.17	Profile 40- 10K	2.39	W	
Förderstreckenelemente	13.01	Profile 40L	2.23	Wandbefestigung	11.22
Forexplatten	7.12	Profile 40MS	2.43	Welle	12.05
Friktionsrollenbahn	13.18	Profile 40N	2.29	Wellenklemmprofil	12.04
Fundamentschraube	5.13	Profile 40S	2.47	Wellgitter	7.14
Fundamentwinkel	5.08	Profile 45L	2.55	Winkel	4.01
Fußplatten	5.06	Profile 45N	2.61	Winkeleinhängung	11.11
		Profile 45S	2.65	Winkelkonsole	4.09
G		Profile 50L	2.71	Winkelleiste	7.07
Gehrungsverbinder	3.18	Profile 50S	2.75	Winkelplatte	3.25
Gelenke	4.12	Profilschienen	13.08	Winkelprofile	2.82
Gewindeeinsätze	3.33			Winkelverbindererelement	4.10
Gewindefüße Kunststoffteller	5.02	R		Würfelverbinder	3.12
Gewindefüße Stahlsteller	5.03	Radienausgleich	11.20		
Gewindehülse	3.33	Radiusausgleich	6.06	Z	
Gewindehülse SF	3.33	Ringschraube	5.07	Zusatzprofile	2.79
Gewindeplättchen	3.28	Rollen mit Anschraubplatte	5.20	Zwischenplatten	7.08
Gittereinfassprofil	7.10	Rollen mit Rückenloch	5.18	Zylinderkopfschrauben	3.22
Glashalter	11.23	Rollenbahn	13.04		
Gleitprofil	12.10	Rollenbahnprofil	13.19		
Griffprofil	8.15	Rolleneinsatz	13.21		
Grundverbinder	3.02	Rollenhalter	13.03		
Gummipuffer	8.21	Rollenschienen	13.08		
		Rücklaufsperr	13.03		

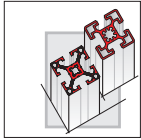

INDEX ENGLISH

INDEX ENGLISH

INDEX ANGLAIS



A					
Accumulator chain transfer SK4	3.20	Friction roller conveyors	13.18	Roller holder	13.03
Additional profiles	2.79	Full plastic	7.12	Roller insert	13.21
Air bar	9.02			Roller rails	13.08
Air supply elements	9.02	G		Rollers	6.08
Alu bracket	4.08	Glass holder	11.23	Rollers with rear hole	5.18
Aluminium hinge system	8.08	Guide rollers	5.14	Rollers with screw on plate	5.20
Angle console	4.09	Gusset plate	3.25	Round profile system Ø48	11.17
Angle element	4.10			Round profiles 40	2.36
Angle element	11.21	H		Rubber buffer	8.21
Angle profiles	2.82	Handle profile	8.15		
Angle rails	7.07	Handles	8.14	S	
Angle suspension element	11.11	Hardboard	7.12	Safety switch	8.20
Appliances	14.01	Height adjusters	5.04	Screw-on bracket	7.08
Automatic BC (Basic Connector)	3.04	Hinge flap profile	8.10	Screw-on plate	5.24
Automaticscrew	3.13	Hinge profile	8.36	Screws- FM	3.16
		Hinges	8.02	Screws- ISO	3.22
				Screws- VSA	3.20
B				Screws- VSI	3.21
Ball clips	8.16	I		Sealing profile	7.04
Base connector	3.02	Insert nut	3.32 / 3.28	Section profile SPR	13.02
Base panels	11.21	Insulating panel	11.16	Shaft	12.05
Base plates	5.06	ISO- screws	3.22	Shaft clamb profile	12.04
Base plates	5.12			Sheet metal hinge	8.04
Bearing unit	12.05	J		Sleeve connector	3.05
Bolt connector	3.06	Joints	4.12	Slide hanger	6.07
Bow handles	8.12			Slide profiles	12.08
Brackets	4.01	K		Slide profiles	12.10
Buffer stop	8.21	Knotted- Plate	3.25	Slider	8.31
				Sliding block	3.29
C		L		Sliding door profile	8.29
Cable bracket	9.10	Latch handle	8.22	Sliding doors	8.35
Cable bushing	9.09	Linear Guiding System	12.02	Snap hook	6.07
Cable duct profile	9.06	Lock	8.22	Sound insulation	11.15
Cable holder	9.10			Spacing plates	7.08
Cap for flange nut	3.22	M		Stopper	13.03
Caps diecast zinc	6.05	Magnetic closure	8.19	Support bracket	5.13
Caps plastic	6.02	Mesh clamping profile	7.10	Support strut	5.13
Caps with impact screw	6.04	Mitre connector	3.18	Surface elements	7.12
Chain conveyor, 3D	13.14	Mounting rim profiles	7.03	Suspension element	11.10
Chipboard	7.13			Swing doors	8.34
Clamping profile 18x32	8.30	N		System hinge, alu	8.08
Clamps	7.09	Non- twisting	3.34	System hinge, plastic	8.06
Connecting strap	3.24				
Connection angle	3.14	P		T	
Connector screw external	3.20	Pipe base clamp	11.22	T - Bolt	3.24
Connector screw internal	3.21	Plastic hinge system	8.06	Telescope profiles	2.81
Conveyor belts	13.12	Plate connector	3.08	Thread covers	5.21
Conveyor Elements	13.01	Pneumatic plate	9.03	Thread feet with plastic plate	5.02
Corner elements	7.11	Polycarbonate	7.12	Thread feet with steel plate	5.02
Countersunk bolt	3.22	Potential equalizer	8.21	Thread inserts	3.33
Cover profiles	7.02	Profile rails	13.06	Threaded plate	3.28
Cube connector	3.12	Profiles 16S	2.03	Threaded sleeve	3.33
Cylinder- head bolt	3.22	Profiles 20	2.07	Threaded sleeve SF	3.33
		Profiles 30	2.13	T - Nut	3.27
D		Profiles 30 -10K	2.19	Toggle catch	8.23
Damper ring	5.02	Profiles 40 -10K	2.39	Tools	14.01
Door handle	8.26	Profiles 40L	2.23	Transport and base plates	5.06
Door knob	8.26	Profiles 40MS	2.43	Transport rollers	5.14
Door lock	8.24	Profiles 40N	2.29	Twin ball clip PA	8.17
Double hinges	8.03	Profiles 40S	2.47	Twin belt	13.16
Double roller	5.17	Profiles 45L	2.55		
		Profiles 45N	2.61	U	
E		Profiles 45S	2.65	Uni connector	3.11
ECO pipe system	10.01	Profiles 50L	2.71		
Emergency handle	8.22	Profiles 50S	2.75	W	
End connector	3.10	Protection fence profiles	11.05	Woven mesh	7.14
		Protection fence system	11.02		
F		Protective fence angle bracket	11.12		
Fillister head screw	3.23				
Fixed caster	5.14	R			
Flange nut	3.26	Radial compensation	6.06		
Floor brackets	5.10	Radius compensation	11.20		
Fluted rubber cover profile	7.06	Rail connector	13.11		
FM - screw	3.16	Rail locator	13.11		
Folding door elements	8.32	Reverse lock	13.03		
Forex- board	7.12	Ring bolt	5.07		
Foundation bracket	5.08	Roller conveyor profile	13.19		
Foundation screw	5.13	Roller conveyors	13.04		

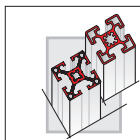

INDEX FRANZÖSISCH

INDEX FRENCH

INDEX FRANCAIS



A		G			
Arbre	12.05	Galets	6.08	Profilés 45L	2.55
Articulations	4.12	Goulotte aluminium	9.06	Profilés 45N	2.61
B		Grille ondulée	7.14	Profilés 45S	2.65
Bloc serrure	8.22	Guidage lineaire system	12.02	Profilés 50L	2.71
Blocage anti- retour	13.03	GV automatique	3.04	Profilés 50S	2.75
Bouton de porte	8.26	I		Profilés complementaires	2.79
Bras de renfort	5.13	Inserts taraudes	3.33	Profilés d'equerre	2.82
Butée	13.03	Insonorisation	11.15	Profilés d'isolement	7.04
C		Interface pour support de pions	8.32	Profilés de protection	7.02
Cache pour écrou	3.26	Interface roulette	5.22	Profilés de protection caoutchuc cannelé	7.06
Caches avec vis	6.04	ISO - Visser	3.22	Profilés de protection de zone	11.05
Caches plastique	6.02	J		Profilés de protection et d'encadrement	7.03
Caches zinc moule sous pression	6.05	Joint à onglet	3.18	Profilés d'encadrement	7.10
Charnière de système, alu	8.08	Joint de connexion	6.06	Profilés ronds	2.36 / 11.20
Charnière de système, polyamide	8.06	Jonction à boulons	3.06	Profilés ronds Ø48	11.17
Charnière en tôle	8.04	Jonction de base	3.02	Profilés télescopiques	2.81
Charnière intérieure	8.10	L		PVC expansé Forex	7.12
Charnières	8.02	Loqueteau à bille PA	8.17	R	
Cheville d'ancrage	5.13	M		Raccord de cube	3.12
Compensateur de rayon Ø48	11.20	Mousqueton	6.07	Rails à galet	13.08
Conduite d'air comprime	9.02	N		Roues guide	5.14
Console d'angle	4.09	Noix Terminale- end	3.10	Roulette légère	5.17
Contacteur de sécurité	8.20	O		Roulettes avec platine	5.20
Conveyeur à bande	13.10	Outils	14.01	Roulettes avec trou central	5.18
Conveyeur à chaine 3D	13.14	P		Roulettes de transport	5.14
Conveyeur à rouleaux à friction	13.18	Panneau de fibres	7.12	S	
Conveyeur à rouleaux	13.04	Panneau iso	11.16	Semelle caoutchouc	5.02
Cornière à panneaux	7.07	Panneaux d'agglomérés	7.13	Serrure	8.24
Corniere d'angle	3.14	Panneaux de remplissage	7.12	Support rouleaux	13.03
Coulisseau	3.29	Pare- fils	5.21	Système de protection	11.02
Coulisseau	6.07	Passe- câbles	9.09	Systeme FM de charnières alu	8.08
D		Patins	12.10	T	
Dispositifs	14.01	Patins de glissement	8.31	Taquet à bille	8.16
Double charnière	8.03	Pieds articulés à embase acier	5.03	Tout plastique	7.12
Douilles- insert autotaraudeuses centrees	3.33	Pieds articulés à embase polyamide	5.02	Transfer à bandes jumelées	
Douilles- insert canele	3.33	Pieds verins	5.04	DG - 0, DG - 2	13.16
E		Pinces	11.25	Transfer à chaine d'accumulation	
ECO- Mecano	10.01	Plaques	3.24 / 11.21	SK - 4	13.20
Ecrou	3.22	Poignée	8.14	U	
Ecrou antirotation	3.34	Poignée de porte	8.26	Union de rail	13.11
Ecrou demi- lune	3.32 / 3.28	Poignée d'urgence	8.22	Unité de roulement	12.05
Ecrou plat	3.28	Poignées à came avec serrure	8.22	V	
Ecrous 1/4 de tour	3.27	Poignées etrier	8.12	Verrouillage magnétique	8.19
Elément à galets	13.21	Polycarbonate	7.12	Vis 1/4 de tour	3.24
Elément d'angle	4.10 / 7.11 / 11.21	Porte- câbles	9.10	Vis automatique	3.13
Elément de suspension	11.10	Portes battantes	8.34	Vis de jonction extérieur	3.20
Elément de suspension articulé	11.11	Portes coulissantes	8.35	Vis de jonction intérieur	3.21
Eléments de conveyeur	13.01	Profilé 18x32	8.30	Vis - FM	3.16
Embase d'ancrage	11.24	Profilé charnière	8.36	Vis - ISO	3.22
Embase de piètement	5.12	Profilé de convoyage	13.02	Vis - VSA	3.20
Embases d'extrémité	5.06	Profilé de porte coulissante	8.29	Vis - VSI	3.21
Entretoises	7.08	Profilé de translation	12.08		
Equaliseur potentiel	8.21	Profilé poignée	8.15		
Equerre à panneaux	7.08	Profilé pour conveyeur à rouleaux	13.19		
Equerre à panneaux crantée	7.09	Profilé rail	13.08		
Equerre d'ancrage au sol	5.08	Profilé support arbre	12.04		
Equerre de alu	4.08	Profilés 16S	2.03		
Equerre de suspension	11.12	Profilés 20	2.07		
Equerres	4.01	Profilés 30	2.13		
F		Profilés 30- 10K	2.19		
Fermeture à genouillère	8.23	Profilés 40- 10K	2.39		
Fixation- HV	3.05	Profilés 40L	2.23		
Fixation- PV	3.08	Profilés 40MS	2.43		
Fixation- UNI	3.11	Profilés 40N	2.29		
FM- Vis	3.16	Profilés 40S	2.47		
Fourreau	5.13				

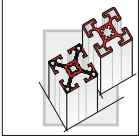

NOTIZEN
NOTES
NOTATION

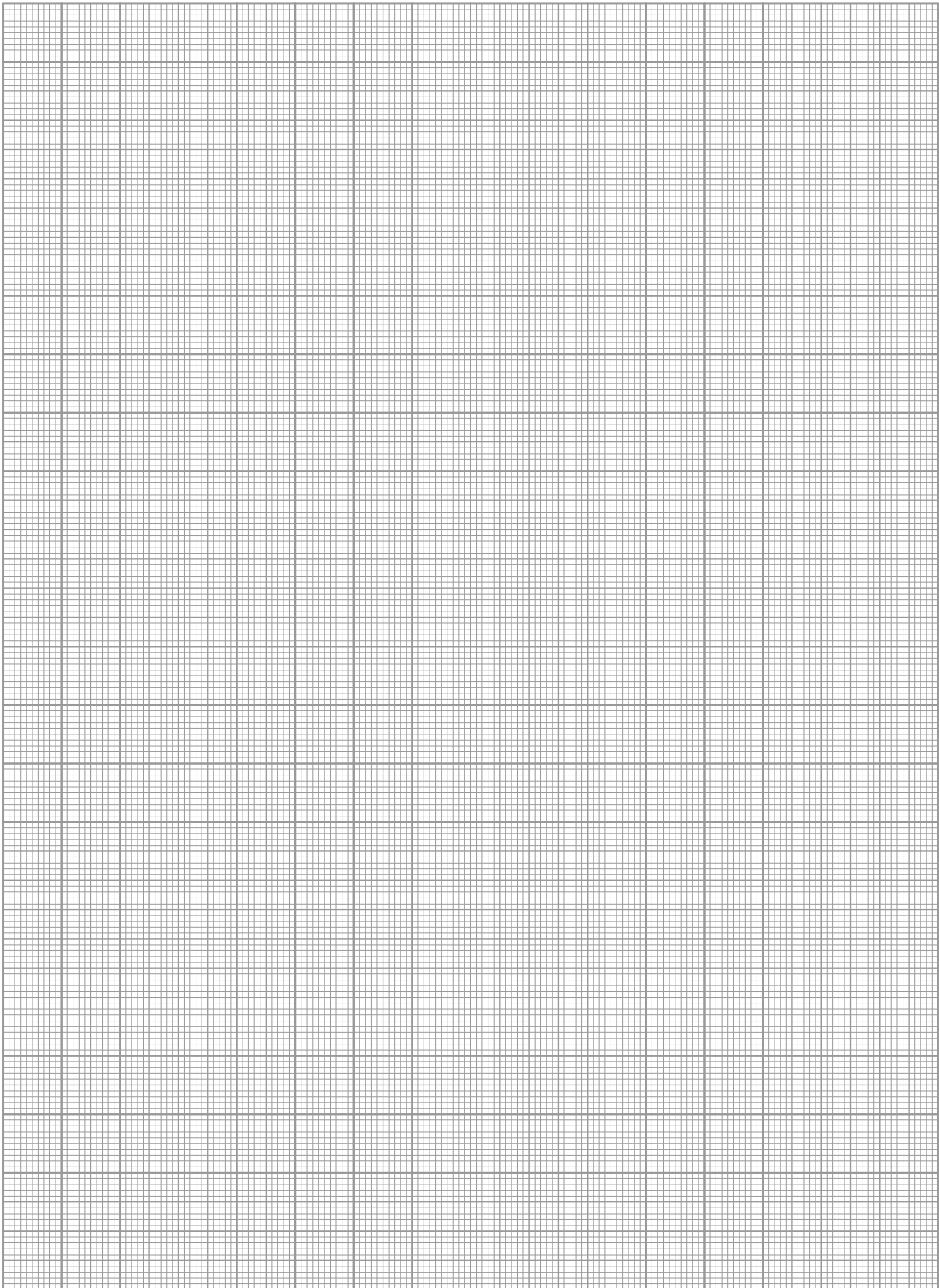

Technische Änderungen vorbehalten

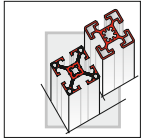

NOTIZEN
NOTES
NOTATION

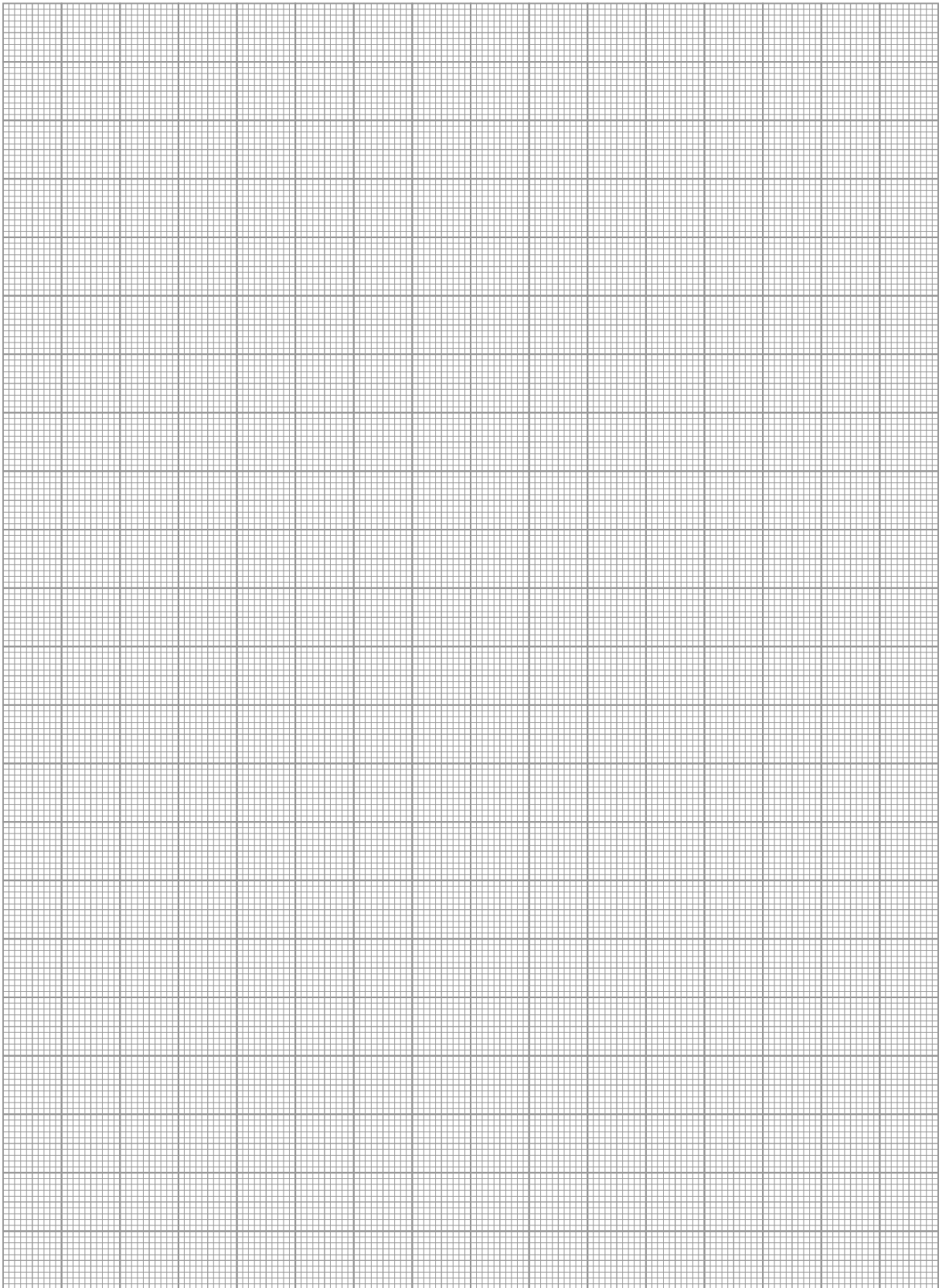



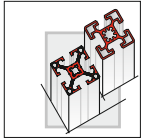



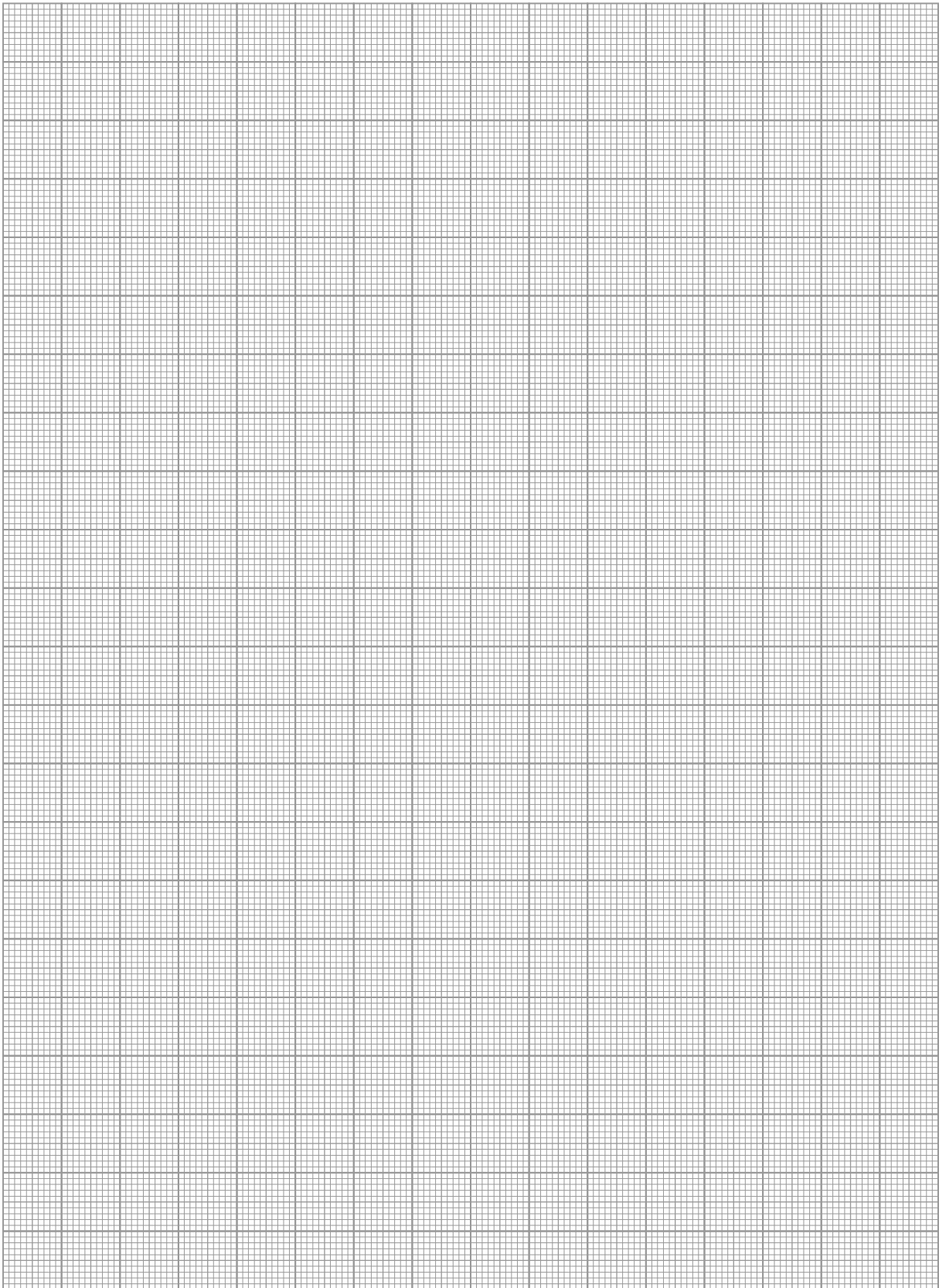







Technische Änderungen vorbehalten



NOTIZEN
NOTES
NOTATION



Technische Änderungen vorbehalten

			
	Nutbreite des Profils 5 / 8E / 8K / 8 / 10	<i>Profile groove width</i> 5 / 8E / 8K / 8 / 10	<i>Rainure</i> 5 / 8E / 8K / 8 / 10
	Profilreihe / Ausführung L = leicht N = normal MS = mittelschwer S = schwer 10K = Kernloch Ø10	<i>Profile series / Version</i> L = light N = normal MS = medium weight S = heavy 10K = core hole Ø10	<i>Série / version</i> L = léger N = normal MS = mi-lourd S = lourd 10K = alésage Ø10
05.01352.00	Bestellnummer	<i>Order number</i>	<i>Référence</i>
■ 1.02 / ➔ ■ 14.01	Seitenzahl / Verweis auf Seite	<i>Page no. / Reference to page</i>	<i>Page / Renvoi en page</i>
	Technische Informationen	<i>Technical Information</i>	<i>Informations techniques</i>
	Profilbearbeitung	<i>Profile processing</i>	<i>Gamme d'usinages</i>
	In Profilbearbeitung: - empfohlen (mit Bearbeitung)	<i>In profile processing: - possible with processing</i>	<i>En gamme d'usinage: - applicable avec usinage</i>
	In Profilbearbeitung: - ohne Bearbeitung	<i>In profile processing: - without processing</i>	<i>En gamme d'usinage: - applicable sans usinage</i>
	Werkzeug / Vorrichtung	<i>Tool / Device</i>	<i>Outils / Gabarit</i>
GD-Al GD-Zn St, vz. VA	Aluminiumdruckguss Zinkdruckguss Stahl, verzinkt Edelstahl	<i>Diecast aluminium Zinc diecast Galvanized steel Stainless steel</i>	<i>Aluminium moulé sous pression Zamak Acier zingué Acier inoxydable</i>
NEW			
	Neuheit	<i>Innovation</i>	<i>Innovation</i>
	ESD - leitfähig	<i>ESD conductive</i>	<i>Matériau conducteur ESD</i>
	Drehmoment [N] / Maximale Belastung [N]	<i>Torque [N] / Maximum load [N]</i>	<i>Couple [N] / Charge maxi [N]</i>
	Verweis auf separaten Katalog	<i>Reference to separate catalogue</i>	<i>Renvoi à un autre catalogue</i>
	FM - Patent	<i>FM patent</i>	<i>Brevet FM</i>



DAS UNTERNEHMEN MIT SYSTEM-DIENSTLEISTUNG

> *THE COMPANY WITH SYSTEM SERVICE*

> *UNE ENTREPRISE AVEC SYSTEME*

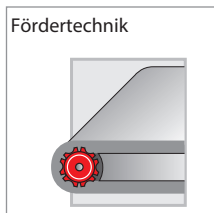
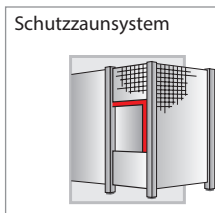
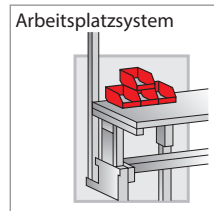
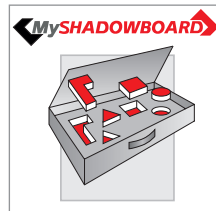
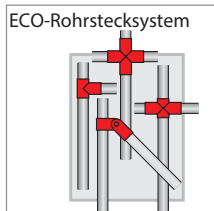
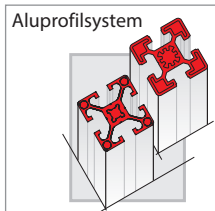

Vertrieb

> *Sales*
> *Vente*



Kontakt

> *Contact*
> *Contact*



Briefing

> *Briefing*
> *Briefing*



Information

> *Information*
> *Information*



Planung

> *Planning*
> *Planification*



Kalkulation

> *Calculation*
> *Calcul*



Entwicklung

> *Development*
> *Développement*



Konstruktion

> *Construction*
> *Construction*



Produktion

> *Production*
> *Production*



Bearbeitung

> *Processing*
> *Elaboration*



Montage

> *Assembly*
> *Assemblage*



Lieferung

> *Delivery*
> *Livraison*



Inbetriebnahme

> *Implementing*
> *Mis en service*